

AUGUST 1985

KEAHOLE, NORTH KONA, HAWAII

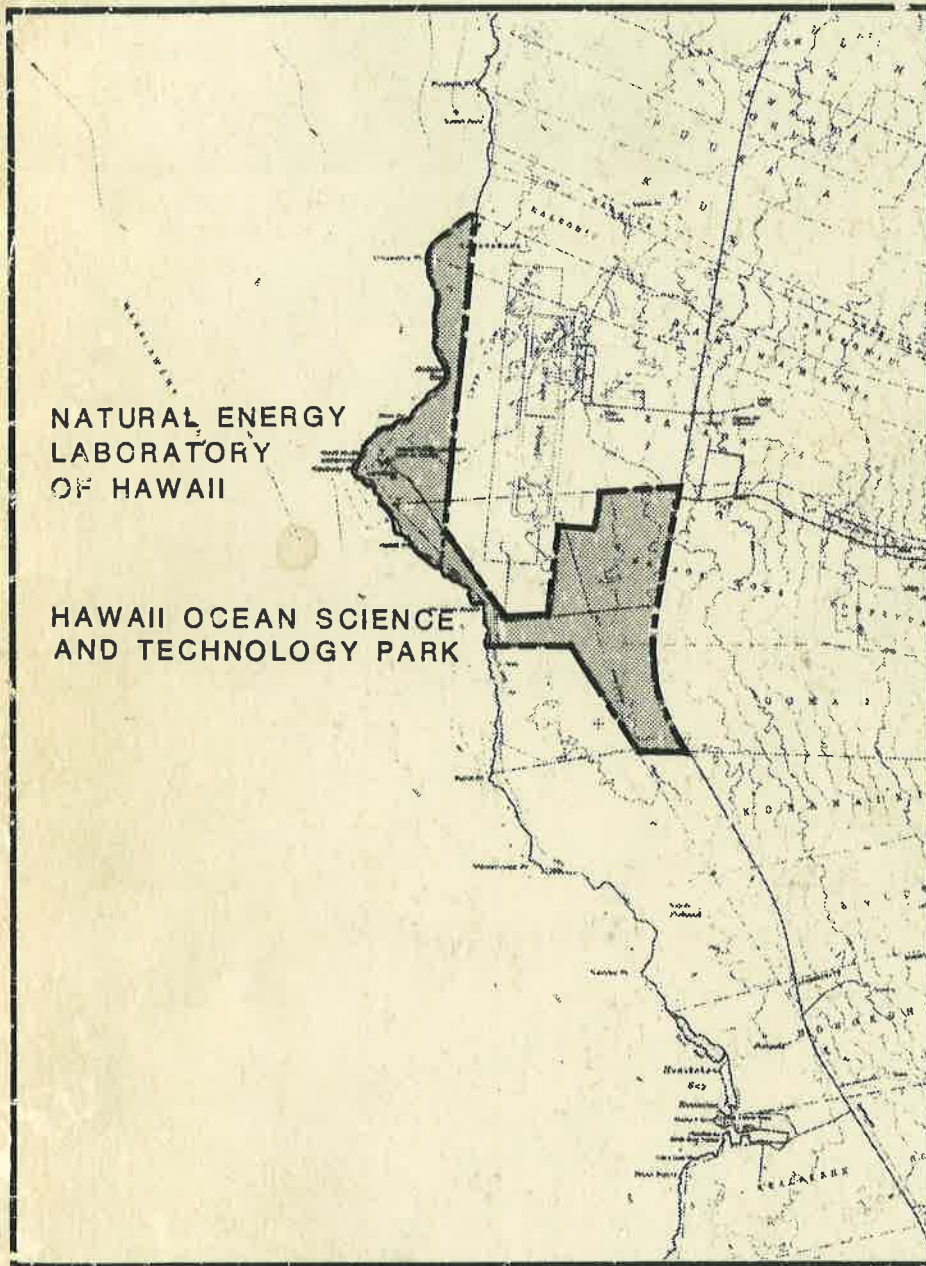

*Final
Environmental
Impact
Statement*

*High Technology
Development
Corporation*



**DEVELOPMENT PLAN FOR THE
HAWAII OCEAN SCIENCE & TECHNOLOGY
PARK AND EXPANSION OF THE
NATURAL ENERGY LABORATORY OF HAWAII**

**ENVIRONMENTAL CENTER
University of Hawaii
2550 Campus Road
Honolulu, Hawaii 96822**

DUPLICATE

~~Herbener due 12/1/88~~
Linda due 5/3/92
Kusumataradja due 11/30/95

FINAL
ENVIRONMENTAL IMPACT STATEMENT
HIGH TECHNOLOGY DEVELOPMENT CORPORATION
DEVELOPMENT PLAN FOR
THE HAWAII OCEAN SCIENCE AND TECHNOLOGY PARK
and
EXPANSION OF THE
NATURAL ENERGY LABORATORY OF HAWAII
Keahole, North Kona, Hawaii

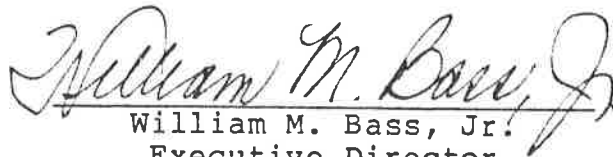
William M. Bass, Jr.
Executive Director

Prepared by:
The Traverse Group, Inc.
Honolulu, Hawaii

August 1985

FINAL ENVIRONMENTAL IMPACT STATEMENT

AUGUST 1985

PROJECT: DEVELOPMENT PLAN FOR THE HAWAII
OCEAN SCIENCE & TECHNOLOGY
PARK AND EXPANSION OF THE
NATURAL ENERGY LABORATORY OF HAWAII

LOCATION: KEAHOLE POINT, NORTH KONA
ISLAND OF HAWAII

PROPOSING AGENCY: STATE OF HAWAII - HIGH TECHNOLOGY
DEVELOPMENT CORPORATION
CENTRAL PACIFIC PLAZA, SUITE 252
220 SOUTH KING STREET
HONOLULU, HAWAII 96813
CONTACT: MR. WILLIAM M. BASS, JR.
TELEPHONE: (808) 548-8996

ACCEPTING AUTHORITY: THE HONORABLE GEORGE R. ARJYOSHI
GOVERNOR, STATE OF HAWAII

CONSULTANT: THE TRAVERSE GROUP, INC.
P.O. BOX 27506
HONOLULU, HAWAII 96827
CONTACT: MARILYNN C. METZ, AICP
TELEPHONE: (808) 732-7143 or (808) 545-3633

TABLE OF CONTENTS

	PAGE
Illustrations	iv
Tables	v
Summary	vi
Purpose of this draft EIS	x
PART I: INTRODUCTION	
A. Hawaii Ocean Science and Technology (HOST) Park	I-1
B. Natural Energy Laboratory of Hawaii (NELH)	I-5
C. Relationship between HOST Park and NELH	I-7
D. Pre-Development Activities	I-8
PART II: PROJECT DESCRIPTION AND ALTERNATIVES	
A. Introduction	II-1
B. HOST Park Development Plan	II-6
C. NELH Development Plan	II-16
D. Ocean Use Corridor	II-23
PART III: THE PROJECT SETTING	
A. The Region	III-1
B. The Keahole Area	III-4
C. The Project Sites	III-8
D. The Marine Environment of the Project Area	III-12
PART IV: IMPACTS AND MITIGATING MEASURES	
A. Introduction	IV-1
B. Methodology	IV-2
C. Impacts of Land Development	IV-4
D. Pipe Construction and Deployment	IV-21
E. Seawater Return Flow	IV-33
F. Socio-Economic Impacts	IV-43
G. Socio-Cultural Attributes and Recreational Resources	IV-65
H. The No-Project Alternative	IV-82
I. Probable Adverse Environmental Effects Which Cannot Be Avoided	IV-83
J. Relationship Between Short Term Uses and Enhancement of Long-Term Productivity	IV-87
K. Irreversible and Irrecoverable Commitment of Resources	IV-88

TABLE OF CONTENTS (cont'd)

	PAGE
PART V: RELATIONSHIP OF THE PROPOSED ACTION TO LAND USE PLANS, POLICIES, AND CONTROLS FOR THE AFFECTED AREA	
A. State Land Use Law	V-1
B. The Hawaii State Plan	V-2
C. Hawaii Coastal Zone Management	V-4
D. Conservation District Policies and Regulations	V-8
E. Hawaii County General Plan	V-9
F. Hawaii County Special Management Area	V-10
G. Hawaii County Zoning and Subdivision Ordinances	V-11
H. Policies and Plans Incorporated by Reference	V-11
I. An Indication of Other Interests	V-11
PART VI: LIST OF NECESSARY APPROVALS	VI-1
PART VII: SUMMARY OF UNRESOLVED ISSUES	VII-1
PART VIII: AGENCIES, ORGANIZATIONS, AND PEOPLE CONSULTED	
A. Agencies, Organization and Individuals Contacted	VIII-1
B. Agencies, Organizations and Individuals Receiving NOP	VIII-5

REFERENCES

Appendix A: RECOMMENDATIONS FOR POTENTIAL AQUACULTURE PROJECTS AT NELH/HOST PARK	
Appendix B: TECHNICAL EVALUATION OF PROPOSED PIPELINES AT NELH/HOST PARK	
Appendix C: TECHNICAL EVALUATION OF SEAWATER RETURN FLOW AND WASTEWATER DISPOSAL SYSTEMS AT NELH/HOST PARK (REVISED)	
Appendix D: VEGETATION AND TERRESTRIAL FAUNA AT NELH/HOST PARK	

TABLE OF CONTENTS (cont'd)

Appendix E:	TRAFFIC ASSESSMENT FOR NELH/HOST PARK
Appendix F:	MARINE ENVIRONMENTAL DESCRIPTION OF NELH/HOST PARK
Appendix G:	POTENTIAL SOCIO-ECONOMIC IMPACTS NELH/HOST PARK
Appendix H:	PUBLIC INFORMATION MEETING
Appendix I:	LIST OF PREVIOUS ARCHAEOLOGICAL SURVEYS AT HOST PARK AND NELH SITES
Appendix J:	COMMENTS AND RESPONSES TO THE DRAFT EIS

ILLUSTRATIONS

Fig. No.		Page
I-1	Project Region	I-2
II-1	Solar Pond Generating Concept	II-3
II-2	HOST Park Conceptual Plan	II-7
II-3	HOST Park Phase I Plan	II-10
II-4	HOST Park Development Scenario A	II-11
II-5	HOST Park Development Scenario B	II-13
II-6	HOST Park Development Scenario C	II-15
II-7	NELH: Existing Conditions	II-18
II-8	Proposed NELH Development Plan	II-22
II-9	Existing Ocean Use Research Corridor	II-24
II-10	Existing 12-Inch Cold Water Pipe	II-25
II-11	Proposed Ocean Use Corridor Expansion	II-28
II-12	Conceptual Pump Station	II-30
II-13	Alternative HOST Park Pump and Pipeline Locations	II-31
III-1	Relative Geographic Size	III-2
III-2	Project Location Map	III-3
III-3	Tax Map Key	III-9
III-4	Adjacent Land Uses	III-10
IV-1	Existing North Kona Water System	IV-6
IV-2	Flood Insurance Rate Map	IV-16
IV-3	HOST Park - Tsunami Inundation Areas	IV-17
IV-4	NELH - Tsunami Inundation Areas	IV-18
IV-5	Conceptual Pipeline Location Along Roadway	IV-23
IV-6	HOST Park Archaeological Sites	IV-66
IV-6A	HOST Park Archaeological Sites (New Site Numbers)	IV-67
IV-7	NELH Archaeological Sites	IV-70

LIST OF TABLES

No.		Page
2-1	Summary of Research Projects at NELH	II-17
2-2	Description of Existing and Projected Pipelines with Associated Inflows/Discharges for NELH and HOST Park	II-27
4-1	Highway Traffic Counts - Queen Kaahumanu Highway	IV-12
4-2	Trip Generation	IV-14
4-3	Total Population and Demographic Breakdowns: State of Hawaii, County of Hawaii, and Possible Affected Areas, 1970 and 1980	IV-44
4-4	Family Characteristics and Income Levels: State of Hawaii, County of Hawaii, and Possible Affected Areas, 1970 and 1980	IV-45
4-5	Labor Force Size and Characteristics: State of Hawaii, County of Hawaii, and Possible Affected Areas, 1970 and 1980	IV-46
4-6	Housing Stock and Characteristics: State of Hawaii, County of Hawaii, and Possible Affected Areas, 1970 and 1980	IV-47
4-7	Average Annual Construction Jobs and Income	IV-51
4-8	Operating Employment and Income, Full Development	IV-52
4-9	Population and Housing, Full Development	IV-53
4-10	Archaeological Sites at the HOST Park Site	IV-68
4-11	Archaeological Sites at the Natural Energy Laboratory of Hawaii Site	IV-71
4-12	Community Priorities on New Industries for Big Island Development	IV-78
4-13	Rates of Recorded Serious Crime for County and West Hawaii	IV-79

SUMMARY

The High Technology Development Corporation (HTDC) was created to demonstrate Hawaii's commitment to the development of high technology enterprises. The HTDC is empowered to develop and administer industrial parks for high technology use and issue special purpose industrial revenue bonds to finance their construction. The proposed Hawaii Ocean Science & Technology (HOST) Park will be HTDC's first development.

A 547-acre parcel of state-owned land at Keahole, Hawaii, was selected for the ocean-related "high-tech" park because of the unique features which the site offers. These include: nutrient-rich, pathogen-free, cold ocean water pumped from depths of 2,000 feet below sea level and greater which are located relatively near shore; high year-round solar radiation with little cloud cover; semi-tropical temperatures and a near hurricane-free environment; and good access, with Keahole Airport adjacent to the site.

One of the most important considerations in siting HOST Park on the Keahole parcel was the close proximity of the 322-acre Natural Energy Laboratory of Hawaii (NELH). NELH was established to manage and operate an outdoor research facility at Keahole Point for research, development and demonstration of natural energy resources.

Research at NELH has proven the value of the pure cold ocean water in the production of mariculture products such as abalone and microalgae. Recent changes in the NELH enabling legislation authorize development, demonstration and commercialization of energy related projects. It is anticipated that this commercial development will take the form of demonstration modules to test the feasibility of various production processes. NELH will act as an "incubator" for projects as they grow from the research stage to large scale production. The adjacent HOST Park will provide the required space for projects transitioning from demonstration to full scale commercial activities.

Because the actual tenants who will locate at HOST Park and at NELH are still unknown, alternative scenarios were constructed to illustrate the extremes of "what might happen" if development progresses in certain directions. The following land use activities are anticipated for HOST Park and are common to all the scenarios:

- o Ocean-water commercial uses such as high intensity commercial mariculture, marine biotechnology, and renewable energy projects;
- o Campus industrial uses such as scientific laboratories, research and training facilities and other uses such as desalination and renewable energy which do not use cold ocean water; and,
- o Service and support uses such as a visitor center/restaurant, light industrial uses, offices, refrigeration, and minimal warehousing and storage related to the primary activities on the site.

The proposed expansion of NELH anticipates a mix of energy and mariculture activities with the highest priority given to alternative energy projects. Preferred mariculture projects would be those that are cold water dependent.

The existing 4 pipelines which supply cold and warm ocean water to NELH for Ocean Thermal Energy Conversion (OTEC) and mariculture projects are located in a corridor which is 1,000 feet wide and extends seaward in westerly direction for approximately one mile offshore of the Keahole Point lighthouse. Use of the corridor for temporary, research facilities (such as pipes, monitoring cables, etc.) was approved by the Board of Land and Natural Resources (BLNR) in 1977. Since 1982, construction of structures in the corridor has been covered under the U.S. Army Corps of Engineers Nationwide Permit for Scientific Structures.

A Conservation District Use Application (CDUA) for an expanded Ocean Use Corridor, that will allow permanent as well as temporary structures for both commercial and research purposes, will be filed with the BLNR in Fall 1985. This Master CDUA, which is intended to supersede the existing CDUA, will conceptually describe all of the pipes projected for NELH and HOST Park at full development (estimated to be approximately 10 to 16) and specifically request permission to construct the initial HOST pipes and the U.S. Department of Energy (DOE) proposed cold and warm water pipes and outfall. A process for approving each additional pipe will be developed in coordination and cooperation with the Department of Land and Natural Resources (DLNR) and will be incorporated into the CDUA. Onshore construction of pipes and pumps will also be subject to the County of Hawaii Special Management Area review process.

At full development of both facilities, it is expected that over 142,000 gallons per minute (gpm) of seawater will be used in energy experiments and mariculture activities. Approximately 16,500 gpm of this used ocean water will be disposed of via a deep ocean outfall, the remaining seawater return flows are proposed to be disposed of in trenches located between 1,000 and 2,000 feet inland from the shoreline. The seawater return flows will essentially be clean water (pre-treated if necessary), differing from the receiving waters primarily in salinity and temperature.

Potential adverse environmental effects which could result from actions during the construction phases of of HOST Park, NELH and the expanded Ocean Use Corridor include: increased traffic; destruction of some strand vegetation during the construction of the on-land portions of the ocean water supply systems; disturbance of resident fauna; displacement or destruction of benthic organisms and potential damage to coral beds as a result of offshore trenching; behavioral modifications among motile organisms as a result of noise and shock waves produced by drilling and blasting in the nearshore waters; temporary turbidity of the offshore waters; and potential destruction of archaeological sites. Most of these impacts will be localized, and only affect the immediate construction area. Mitigating measures will be instituted to minimize the effects.

Operation of HOST Park and expanded NELH facilities, and the associated ocean use corridor, could also generate adverse environmental effects. It should be emphasized that the EIS evaluation was for "worst case" scenarios at full development. Since development will be incremental, these effects can be monitored and mitigating measures can be instituted before the impacts become

significant. Potential environmental impacts include: disruption and displacement of the existing brackish water lens resulting from on-land disposal of ocean water; loss of some kiawe trees on site due to the change in salinity of the lens caused by the ocean water plume; changes in the salinity of any of the anchialine ponds on the project site; and detrimental effects on the coral community caused by the temperature of the seawater return flows. An intensive monitoring program, which will include the drilling of monitoring wells, will be undertaken to assess the effects of the flows on the aquifer, and its consequent offshore effects. If unanticipated impacts occur or if the expected effects become too severe, alternative methods of disposal, such as ocean outfalls, can be utilized. The effects on the aquifer of on-land disposal are reversible. Once seawater return flows cease, the aquifer will revert back to its existing condition and most of the affected environment will return to its pre-disposal state.

Line 8

The water-quality monitoring activities at NELH will enhance knowledge of coastal and ocean processes and facilitate the development of standards for mariculture and other ocean-related research and development activities throughout the state. Monitoring is high priority because preservation of the integrity of the cold and warm ocean water resources is fundamental for the continued growth and success of the proposed projects. If the water is degraded, the projects will no longer have the unique resource necessary to attract the energy and mariculture activities important to their success.

The operation of between 10 to 15 additional intake pipes could result in impingement and entrainment of organisms. Little effect is expected from the cold water intake pipes but warm water pipes in shallower waters could affect larval fish. At present there is no conclusive evidence of actual declines in any fishery due to impingement or entrainment losses.

Increased public access resulting from operation of HOST Park could have some detrimental effects on the beach recreation; it could lead to overuse and congestion. Other potential problems are the increased chance of vandalism and problems with litter and beach maintenance. At some time in the future, an enforceable management-monitoring program may have to be developed to insure that the beach areas are not irretrievably destroyed by indiscriminate use.

New jobs created as a result of the development of the proposed facilities may impact the West Hawaii housing market. Unlike resort development, where the number of potential employees is known prior to construction and where the employees all come "on-board" at the same time, the contribution of the HOST and NELH projects is expected to be comparatively modest since expansion is expected to be relatively gradual. Both HTDC and NELH will work closely with Hawaii County and the Hawaii Housing Authority to develop solutions to housing problems that may result from operation of the proposed projects.

The appearance of the inland areas of the HOST Park site will change, as is always the case when barren lava land is developed. Because of FAA regulations regarding construction near airports, all structures will be lowrise. In addition, large lots will provide extensive areas of relatively open space. Every effort will be made to insure ocean views. Nevertheless, the presence of header tanks, pipes, ponds, raceways, building and parking areas on a formerly undeveloped site may be considered a negative impact by some people.

The construction and operation of the proposed projects will involve the irretrievable commitment of certain natural and fiscal resources. Major resource commitments include land, money, construction materials, manpower and energy. The impacts of using these resources should be weighed against the economic benefits to the residents of the state.

The proposed HOST Park and the expansion of NELH will be an important addition to Hawaii's growing research and development industry and to Hawaii's search for economic diversification and alternative energy resources. The commercial activities at HOST Park are expected to diminish West Hawaii's dependency on tourism for long term employment for residents. Development of the proposed projects can enhance the image of the state and county as a world leader in ocean-based science and technology.

The major tradeoffs between development and environmental effects will be related to the potential disruption and displacement of the existing brackish water aquifer resulting in some potential impacts to vegetation and anchialine ponds and the change in the character of the area by the presence of industrial activities on formerly open barren lava land. These impacts are reversible and can be mitigated. Some risk is also present to the offshore coral beds and mitigating measures must be taken to insure that they are not damaged.

This environmental impact statement has been prepared to disclose the potential implications of proceeding with the proposed developments. It will be the responsibility of various state, federal and county officials to evaluate the tradeoffs between economic development potential and effects on the natural environment and to make informed decisions based on knowledge of the potential consequences.

Mitigating measures, as outlined in this report can be incorporated into the various permits required by these agencies. If properly monitored, almost all of the potential negative environmental effects of the project on the natural environment can be reversed and/or mitigated.

PURPOSE OF THIS ENVIRONMENTAL IMPACT STATEMENT

This environmental impact statement has been prepared for the following purposes:

1. to comply with Chapter 343, Hawaii Revised Statutes;
2. to comply with EIS Regulations Section 1:31 c.1;
3. to inform the public of the proposed HOST Park and related actions at NELH and to obtain comments on the proposed actions;
4. to assess the environmental setting of the HOST Park site and surrounding areas;
5. to evaluate the possible environmental impacts of the proposed actions;
6. to outline mitigating actions for potential impacts;
7. to consider alternatives to the proposed actions and the impacts of those alternatives; and,
8. to fulfill the environmental requirements for a State Land Use District Boundary Amendment, a County of Hawaii Zoning Change and Special Management Area Use Permit, and a Conservation District Use permit.

Comments received during the public review period were addressed and incorporated into or appended to the final environmental impact statement.

PART I: INTRODUCTION

A. HAWAII OCEAN SCIENCE AND TECHNOLOGY (HOST) PARK

1.0 Background and Purpose

To demonstrate Hawaii's commitment to the development of high technology enterprises, the 1983 Hawaii State Legislature created the High Technology Development Corporation (HTDC). The Corporation is governed by a nine-member Board of Directors. The Corporation is assigned to DPED for administrative purposes. Pursuant to Chapter 206M, Hawaii Revised Statutes, the HTDC is empowered to develop and administer industrial parks for high technology use and issue special purpose industrial revenue bonds to finance their construction.

A report, "Statewide Strategy For High Technology Growth" (HTDC, 1984) was published in December 1984. In this report HTDC recommends that:

...Hawaii concentrate its efforts and resources on developing those forms of high technology that build upon its unique resources and the geographical advantages derived from its location in the center of the North Pacific Ocean.

High technology industries fitting this definition were determined to be primarily in the areas of astronomy, software development, renewable energy, oceanography, aquaculture, electronic design and assembly, biotechnology, telecommunications, pharmaceuticals, and tropical agriculture. HTDC also recommends that:

...Hawaii remain flexible and ready to respond to new developments in high technology by continually reviewing this definition of high technology and adding or deleting elements as circumstances warrant.

2.0 Characteristics of the Site

HTDC evaluated various candidate sites in order to identify those having the best potential for high technology park development. One of HTDC's first recommendations was that an ocean science and technology park be developed on state-owned lands located at Keahole Point, North Kona, Hawaii (Figure I-1). The Keahole location was selected for an ocean-related "high-tech" park because of the unique features it has to offer. Briefly, they are:

- o Nutrient rich, pathogen free, cold ocean water (less than 50 degrees F), pumped from depths of 2,000 feet below sea level and greater which are located relatively close inshore;
- o Close proximity to the Natural Energy Laboratory of Hawaii (NELH) facilities which could serve as a research and pilot location for budding ocean science industries;
- o High year-round solar radiation (one of the highest levels in the U.S.) with very little cloud cover;

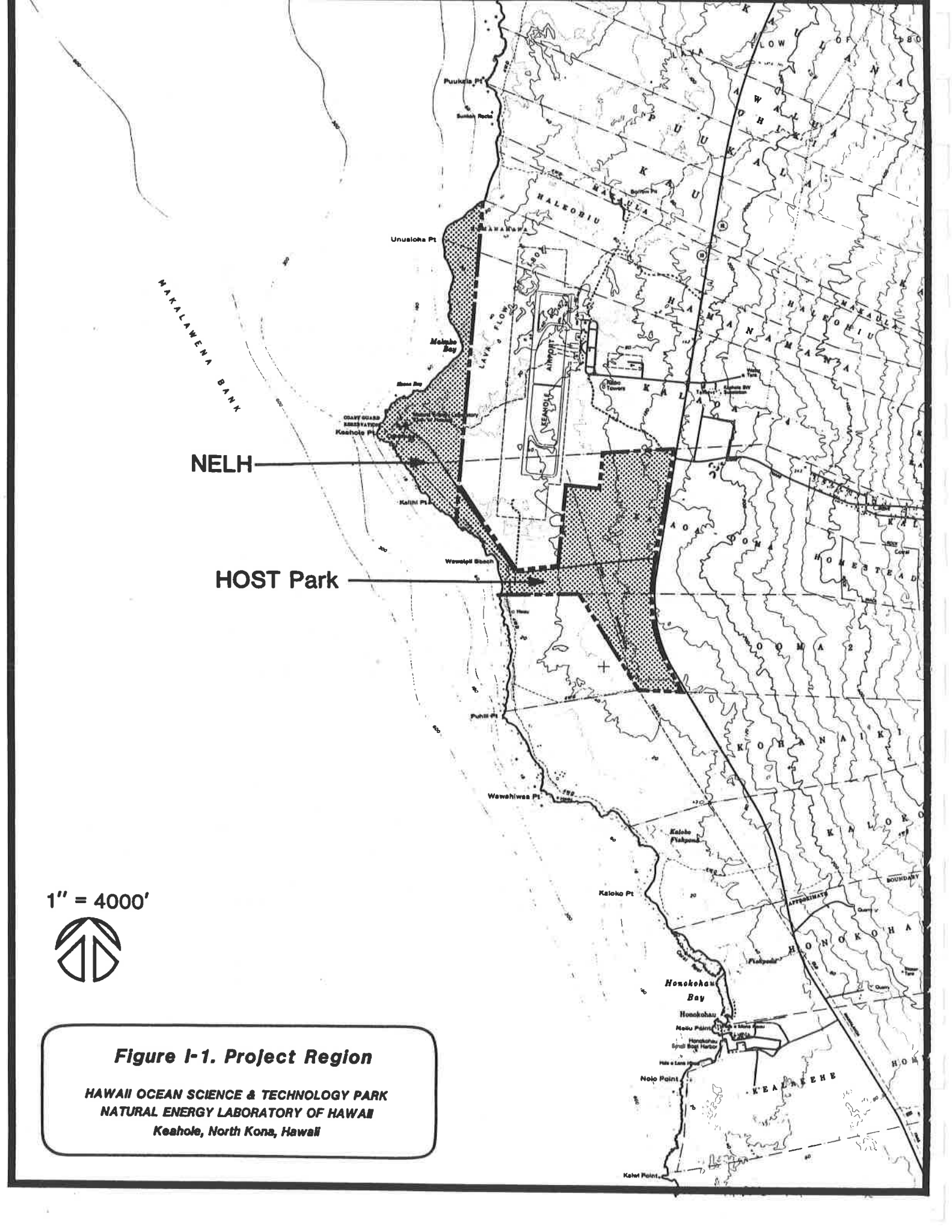

NELH

HOST Park

1" = 4000'



Figure I-1. Project Region
HAWAII OCEAN SCIENCE & TECHNOLOGY PARK
NATURAL ENERGY LABORATORY OF HAWAII
Keahole, North Kona, Hawaii

- o Semi-tropical temperatures with light diurnal breezes which keep the temperatures relatively constant and comfortable while providing a near hurricane-free environment; and,
- o Good access, with Keahole Airport adjacent to the site, and Kawaihae Harbor within a forty-five minute drive on a recently completed limited access highway.

3.0 Proposed Uses of the Site and Criteria for Tenant Selection

An assessment of the potential market mix for the Hawaii Ocean Science and Technology (HOST) Park was undertaken in January 1985 (Helber, Hastert, Van Horn and Kimura, 1985). The results of the survey indicated that there is no other ocean-related park in existence which could compete with the type of development being planned by HTDC for Keahole.

The types of companies that were identified as being prospective occupants of the park are:

- o High intensity aquaculture
- o Alternate energy
- o Marine biotechnology
- o Pharmaceutical development
- o Oceanography
- o Tropical agriculture

A draft set of criteria for selecting the types of tenants to be allowed at the HOST Park is currently being reviewed by the HTDC Board. These draft policies include the following:

- o Acceptable uses that conform to the stated nature of the HOST Park include: aquaculture, microbiology, biotechnology, oceanography, renewable energy or desalination and other forms of ocean-related high technology deemed appropriate by the HTDC Board of Directors. Within limits, a small portion of the Park can be set aside to accommodate support services that are related to ocean-related uses present in the park.
- o Priority consideration should be given to mariculture, other ocean-related activities and renewable energy/desalination forms of high technology that are transitioning from research and development projects at the adjacent Natural Energy Laboratory of Hawaii (NELH) to full commercial application at HOST Park.
- o Proposed operations should be compatible with other uses of the park, present or anticipated; uses that would tend to pollute the environment or might in any way degrade the the purity of the surface-level and deep water resource will not be accepted.

- o Resources should be available to meet the infrastructure requirements of the prospective tenant. In particular, the need for cold ocean water.
- o Prospective tenants should be evaluated on their potential for success and long-term stability.
- o Priority consideration should be given to applicants who plan to utilize the unique resources of the site extensively.

The final decision on tenant acceptability will be made by the Board of Directors of HTDC.

B. NATURAL ENERGY LABORATORY OF HAWAII (NELH)

1.0 Background and Purpose

The Natural Energy Laboratory of Hawaii was established by the Hawaii State Legislature in 1974 by Act 213 to manage and operate an outdoor research facility at Keahole Point on the island of Hawaii for research, development and demonstration of natural energy resources. Recent changes in the legislation authorizes development, demonstration, and commercialization of energy and related projects. NELH is governed by a managing board consisting of seven ex-officio voting members. Like HTDC, it is placed within DPED for administrative purposes (Ch. 227, HRS).

NELH is the only existing facility of its type where large volumes of both deep cold and warm surface seawater are continuously pumped ashore. This deep cold water has proven attractive for many types of aquaculture because of its abundance of nutrients and the low level of pathogens. As a result, aquaculture activities are as great an interest to potential researchers and developers as energy-related projects at the facility.

At the present time, about one-third of NELH's operating funds are provided by the State of Hawaii. Major investments have been made in the facility by both the state and the federal government, in both energy and mariculture projects. Additional investments have been and are being made by the private sector.

2.0 Continuing Planning Process

In the last few years, the Natural Energy Laboratory has grown rapidly. The success of the facility has created both problems and opportunities. For example, one of the objectives of the NELH is to be financially self-sufficient. Although commercial projects can and do provide much needed revenues, the original research purpose of the laboratory needs to be retained, and sufficient space must be preserved to allow room for new projects. Further, because NELH is a very special kind of scientific/industrial park, unique in the world, priority must be given to research and development that require the ocean water resource.

Major developments are occurring in the Keahole area that could affect or be affected by NELH. Among these are the expansion of the Keahole airport by the State Department of Transportation, the development of the nearby Keahole Agricultural Park, the the proposed HOST Park and the development of two privately developed industrial parks. These developments may both constrain and provide new opportunities for the growth of NELH.

A master plan for NELH was prepared in 1976. It is primarily a physical plan, delineating specific areas for the access road, laboratory, and administration building, with space allocated for the future development of research projects, including Ocean Thermal Energy Conversion (OTEC), both land based and floating; solar energy; and mariculture/biomass conversion.

A draft update of this plan, which was presented to the NELH Board of Directors on June 20, 1985, builds on the earlier effort. It includes both revisions to the original physical plan and sections on management and institutional alternatives, and economic and financial considerations.

Key institutional, land use, economic and environmental issues, and opportunities and constraints which could affect the future development, growth and viability of NELH are addressed in the plan. Existing and potential research and development (R&D), governmental, university and commercial programs and activities; their needs, scope and anticipated relative emphasis within NELH are identified. Generalized facility and infrastructure requirements, development costs, revenue estimates and regional implications are also described.

3.0 Goals, Objectives and Criteria

The final development plan will be established by the NELH Board. It will reflect the goals and objectives for the development, growth and operation of the NELH. An initial list of goals and policies were identified and presented to the NELH Board.

Among the goals and policies being considered by the Board are:

- o Establish the NELH at Keahole as a major center for research demonstration, development and commitment of natural energy resources and other compatible scientific investigations.
- o Establish a solid economic foundation and marketing program to ensure continued success of the facility.
- o Support research which takes advantage of unique characteristics of the site.
- o Serve as an incubator to develop technology to commercial applications.

A number of short term and long term considerations were taken into account in the planning process. These considerations include previous actions and policies; legal and institutional opportunities and constraints; economic and market analyses; potential for growth; scale of development appropriate for the area; interdependence with other potential activities; utilization of and need for location near the unique resources of the site; land use and infrastructure implications; regional impacts; costs; and revenues.

These considerations and the degree to which each meets the established goals, objectives, and policies were the basis for the evaluation of prospective uses for NELH.

C. RELATIONSHIP BETWEEN THE HOST PARK AND NELH

It is anticipated that commercial development at NELH will take the form of demonstration modules to test the feasibility of producing various products for market. NELH will act as an "incubator" for projects as they grow from the research stage to large scale commercial production. The proposed HOST Park, which will be located on adjacent property, could provide the required space for projects transitioning from demonstration to full scale commercial operations. Together, the NELH and the HOST Park could be marketed as an attractive and complementary package to high technology corporations which may be interested in establishing their operations in Hawaii.

D. PRE-DEVELOPMENT ACTIVITIES

1.0 HOST Park

A marketing and feasibility study for the HOST Park was completed in January 1985 (Helber, Hastert, Van Horn and Kimura, 1985). This study included a preliminary market study, a conceptual master plan, a conceptual infrastructure plan, an analysis of ocean water supply and disposal systems, preliminary cost estimates and proposed construction phasing. It was the basis for a petition requesting a State Land Use District Boundary Amendment from Conservation to Urban.

Detailed master planning and infrastructure design for the proposed park commenced on July 1, 1985. This planning and design phase of project development is intended to implement the concepts identified in the marketing and feasibility study. Master Planning products will include the following:

- o An ultimate site plan which will be flexible in meeting changes for a different mix of lot sizes;
- o A civil master plan which will show roadways, lots and utility corridors and other infrastructure requirements including a cold ocean water supply system, a warm ocean water supply system and a seawater return disposal system;
- o A landscaping master plan;
- o An archaeological mitigation plan;
- o An incremental development plan; and,
- o Development rules and design standards.

The Development Rules (CC&Rs) and design standards will include: (1) the range of commercial activities that may occur within the HOST Park; (2) design guidelines; (3) landscaping requirements; (4) archaeological mitigating measures; (5) sewage disposal system requirements; (6) county building codes; (7) conditions placed on development by the Federal Aviation Administration (FAA); and (8) conditions placed on permits issued by various state and county agencies, including mitigating measures recommended in this EIS.

A master plan report covering the items mentioned above will be published. This report will form the basis for a County of Hawaii Special Management Area Use Permit (SMA) and Zoning change; a County of Hawaii Planned Unit Development (P.U.D.) Application; a Conservation District Use Application (CDUA) for construction and operation of proposed and future cold water and warm water pipes in the waters off Keahole Point; and a shoreline setback variance.

2.0 NELH

The updated conceptual master plan for NELH, which is currently being reviewed, allows for commercial development of research projects at the facility. Expansion of the NELH ocean research corridor to accommodate additional pipes was studied

in coordination with HOST Park planning and the environmental impact analysis presented in this EIS. A new Master CDUA is being prepared to allow the use of this expanded corridor and to allow permanent pipes which will be used for commercial purposes. (The existing CDUP restricts pipes to temporary, research.) The updated NELH Master Plan will also be the basis for a new County of Hawaii SMA permit and shoreline setback variance. Eventually, a P.U.D. for the facility may also be proposed.

3.0 Basis for this Environmental Impact Statement (EIS)

After receiving comments on the petition that was filed for HOST with the State Land Use Commission, comments on the NOP, and comments from various state and county agencies, it was determined that refinements to the original HOST concept were required in order to more fully disclose the implications of the plan. It was also decided that areas should be set aside for smaller lots as well as the large 10 to 20 acre parcels envisioned in the conceptual plan. In addition, a draft updated NELH conceptual plan has been completed. This plan was not available when the NOP was published.

Because the actual firms and projects that will locate at HOST Park and NELH are still unknown, this EIS, although based on the plans and studies described in the previous paragraphs, assesses and evaluates the environmental implications of several possible development scenarios. The assumptions of these scenarios are described in Part II.

The environmental impact analysis is based on "worst-case" "what-if" situations reflecting reasonable full development expectations for each facility. The purpose is to identify the risks involved in various courses of action so that, if required, modifications can be made to the plans. The EIS is intended to be used by the key decision-makers both in finalizing their development plans and in evaluating the suitability of prospective tenants and projects as development progresses. Recommendations for monitoring the effects of various elements of the development process on the environment are presented; this monitoring can facilitate the making of incremental decisions.

It should be emphasized that many of the worst case situations are theoretical and generally conservative. The activities proposed are state-of-the-art and deal with many unknowns. Although the EIS is intended to cover both planned and future projects at each facility, if a new activity emerges with unique requirements that may increase the magnitude of the impacts presented in the EIS, an environmental assessment will be made and the Office of Environmental Quality Control will be asked to determine if a Supplemental EIS is required.

Finally, the question of ceded lands and amounts due to aboriginal Hawaiians will not be addressed in the EIS. The matter is currently being litigated and it was felt that a discussion of the implications of the requirements which will emanate from the court decisions would be premature at this time.

PART II: PROJECT DESCRIPTION AND ALTERNATIVES

A. INTRODUCTION

The proposed projects will be described within the context of alternative development scenarios. This approach is necessitated by the fact that plans for both NELH expansion and HOST Park are in the conceptual phase; no detailed site plans have been adopted for either facility and few on-site engineering studies have been performed. In addition, the proposed projects are, in many cases, state-of-the-art and research oriented, dealing with many unknowns. Although the scenarios all reflect the goals and objectives of each facility, they take into consideration the present uncertainty as to the characteristics of the future tenants and their physical and operational requirements. The alternatives allow for development flexibility so that each facility can respond to changing market conditions and/or technology. Actual development will probably take the form of a combination of alternatives.

The following activities are among those proposed for development within one or both of the facilities:

- o Mariculture

The propagation and cultivation of aquatic animals and plants for profit or other social benefit is termed aquaculture. Aquaculture is carried out in fresh water or saltwater or any mixture of the two, i.e., brackish water. Aquaculture activities which take place in brackish water or seawater are generally referred to as mariculture. Commercial mariculture is based on the proven assumption that through manipulation of the aquatic environment (such as altering breeding patterns to increase the frequency of spawning), greater numbers of aquatic animals and plants can be harvested per unit area of water than what is normally produced in the natural environment. (DLNR, 1981)

Mariculture, utilizing the deep, cold, nutrient-rich, pathogen-free ocean water and warm surface waters unique to the site (as initially developed for Ocean Thermal Energy Conversion (OTEC) research), is the type of aquaculture activity proposed for the HOST Park and NELH expansion. Types of culture anticipated are algae; crustaceans; mollusks; non-bivalve mollusks (such as abalone); and finfish. A report prepared by The Traverse Group, Inc. discussing the various production and harvesting techniques and areal and water requirements for these various types of culture is incorporated into this EIS as Appendix A.

- o Ocean Thermal Energy Conversion (OTEC)

OTEC is a power generating system that uses the temperature difference between warm surface water in the tropical ocean and the cooler water at depth to run a heat engine. Two OTEC operating cycles are currently under development in the United States: closed- and open-cycle. Because the technology is highly experimental, little published technical information is available.

In closed-cycle systems, a low-boiling point working fluid (ammonia or Freon) flows through a series of components in a closed loop. The main components are two heat exchangers, a turbogenerator, and a feed pump. The working fluid is vaporized by heat from the warm seawater and passed through a turbogenerator to generate electricity. To complete the cycle, the fluid is then condensed by the cold seawater transported to the surface via the cold water pipe (U.S. Department of Energy, 1985).

In open-cycle operations warm surface water is used as the working fluid. Prior to evaporation the water is degassed, removing dissolved oxygen, nitrogen, carbon dioxide, and trace gases from sea water. Once in the evaporator under partial vacuum, the seawater is separated into steam and brine. The steam, after passing through a turbine, is condensed using cold ocean water.

For open-cycle systems using direct contact heat exchangers, the cold water stream may be degassed prior to use in the condenser. Inside the direct contact condenser, the cold water will release more non-condensable and trace gases. A number of fluid streams result from open-cycle operations as well as atmospheric releases. The fluid streams either can be discharged directly, combined and discharged, or used for other secondary economic purposes, such as mariculture or solar ponds, either directly or in various combinations and then discharged. Open-cycle OTEC will probably necessitate larger flows, and thus larger pipes, more extensive construction, and larger buildings than closed-cycle OTEC (Marine Sciences Group, 1985).

o Solar Ponds

A solar pond is a body of water that converts solar energy into thermal energy; "salt gradient" ponds are the type being discussed for operation in the Keahole area. As described in laymen's terms by SETS, Inc. (1983):

In a solar pond used for making electricity, the sun provides the heat. The heat is stored in the heavy very salty water at the bottom of the pond. On the top of this salty water is a layer of lighter cold fresher water. The hot salt water is too heavy to rise and heat is stored in this water. The hot salt water is pumped through a heat exchanger to vaporize a working fluid to turn a turbine wheel and the electrical generator linked to it. The cold fresher water is used to turn the vapor back to a liquid so the process can start again. Solar ponds can provide firm power 24 hours a day, 365 days a year. (Figure II-1)

Salt-gradient solar ponds have many potential applications which include: residential and commercial space and water heating, agricultural and industrial process heat, electric power generation, and desalination.

The major components of a SPOTEC Power Plant facility are: an energy pond; an energy conversion system; brine supply; and system plumbing. For a 15/30 KWe facility the minimum pond surface area would be 0.81 acres with a maximum of 1.31 acres; energy collection area from 0.64 acres to a maximum of 1.15 acres; and pond bottom area from 0.50 acres to a maximum of 1.00 acres. For a 300/600 KWe facility the pond surface area range would

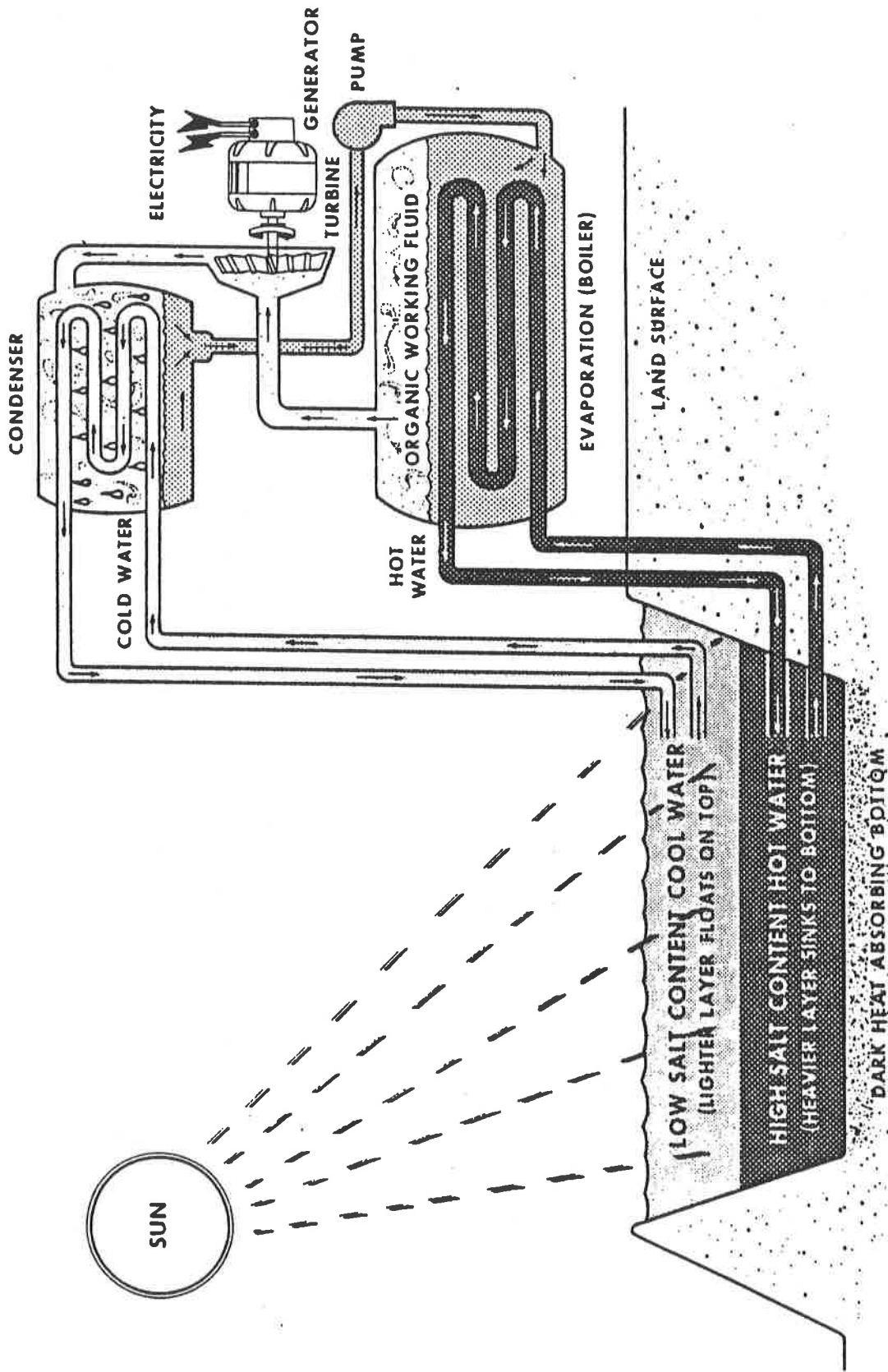

**Figure II - 1. Solar Pond
Generating Concept**

HAWAII OCEAN SCIENCE & TECHNOLOGY PARK
NATURAL ENERGY LABORATORY OF HAWAII
Keahole, North Kona, Hawaii

be 11.78 acres to 22.65 acres; energy collection area from 10.88 acres to 21.31 acres; and pond bottom area from 10.00 acres to 20.00 acres. SETS recommends above-ground ponds because of the closeness of the water table in the Keahole area. Water below the ponds can carry away heat. Artificial liners are needed to seal the ponds and prevent brine loss. The ponds would be about 12 feet deep with 10 feet of brine and water structured to have about one foot of surface zone, four feet of gradient zone and five feet of storage zone.

The power plant for a 30 KWe plant would probably consist of two, 15 KWe Rankine-cycle-engine generator sets. The second generator would be operated when demand requires.

The types of salt that can be used in a solar pond include sodium chloride, magnesium chloride, sodium carbonate, sodium sulfate and others. The basic requirement is high solubility and transparency, and a solubility curve which does not decrease with increasing temperature. Salt can be purchased to make brine or brine can be made locally by evaporating sea water. It can also be obtained as a by-product of a desalination plant. Approximately 2000 tons of salt or about 7-acre feet of brine are needed.

During operation the pond surface water will evaporate slowly and must be replenished. NELH or HOST can provide warm sea-surface water, deep cold ocean water and fresh water. The recycling of pond surface maintenance water is possible if brine production is included as part of a SPOTEC facility. This would eliminate the need to dispose of this water into the ground.

o Desalination

A desalination plant, using reverse osmosis, has been proposed. Such a plant, if it was of sufficient size and if it could be proved to be cost-effective, could provide for the fresh water needs of the HOST and NELH properties, or the fresh water could be sold to other commercial users.

Reverse osmosis is a scientific method of reversing nature's biological process where a dilute or lighter solution passes spontaneously through a semiporous membrane into a more concentrated solution. For example, fresh water will flow through an osmotic membrane to mix with a heavier brackish or seawater solution. As the water passes through the membrane, the pressure on the dilute side drops. Simultaneously, the pressure of the concentrated solution rises until equilibrium is reached, halting the flow through the membrane. The difference in pressure between the two solutions in this state of equilibrium is known as the system's osmotic pressure.

In the reverse process, water from concentrated solutions passes through selective membranes and emerges as pure water. The basic reverse osmosis concept is to apply sufficient pressure to the concentrated solution (above its osmotic pressure) and, in reversing the flow through a semi-permeable membrane, filter out salts and other dissolved solids. Reverse osmosis systems can operate at room temperatures and require mechanical power only. For many seawater desalination applications, reverse osmosis can operate at a fraction of the energy costs required for distillation.

Other than cost, the major problem is the disposal of the salt solution. A desalination plant operated in conjunction with a SPOTEC plant would be a practical solution to this problem.

B. HOST PARK DEVELOPMENT PLAN

1.0 Conceptual Plan

A conceptual plan for the HOST Park was presented as part of the marketing and feasibility studies for the HOST Park (Helber, Hastert, Van Horn & Kimura, Inc., 1985). Since the report was published in January 1985, interim planning has taken place in order to refine the concept. Detailed planning for the park is scheduled to begin in July 1985; the detailed master plan will be based on the concepts presented in this EIS and will be used as the basis for first phase infrastructure design.

The following planning guidelines were utilized in developing the master plan concept:

- o Keahole Point was chosen as the site for proposed HOST Park because of the nearby availability of cold, deep ocean water; a warm ocean surface layer not subject to strong seasonal cooling; and high annual solar insolation. Experiments at adjacent NELH have shown that the cold ocean water is also nutrient rich and virtually pathogen free. Utilizing these unique resources was a major objective in developing the HOST Park Conceptual Master Plan.
- o Protection of the physical and chemical water quality of the cold water and surface water resources was a major consideration in preparing the HOST Park Conceptual Plan. The potential continued success of both HOST Park and NELH is dependent upon maintaining the high quality of source water.
- o Possible synergetic relationships between NELH and HOST Park were also considered in determining the appropriate types of high technology companies which should be encouraged to locate at HOST Park. For example, types of operations that would utilize space at NELH for pilot plants to demonstrate project feasibility and then move to HOST Park for full-scale commercialization of the projects. These relationships were also a prime consideration in updating the NELH Master Plan.
- o The location of the Keahole Airport, adjacent to both NELH and the proposed HOST Park, was a major planning consideration for both facilities. The airport presented both constraints (e.g. building height restrictions, no-build areas) and opportunities (access, shipping, etc.).

The major elements of the original HOST Park concept (as presented in the marketing and feasibility report and the notice of preparation of EIS) are shown in Figure II-2. They include:

- o Retention of the shoreline for public use and possible construction of a small paved public parking area and restroom facility approximately midway along the ocean frontage.
- o Provision of large lots (10 to 20 acres in size) in the lower portions of the site for tenants who require high volumes of ocean water for their operations. (e.g., for full-scale commercialization of high-intensity mariculture activities.)

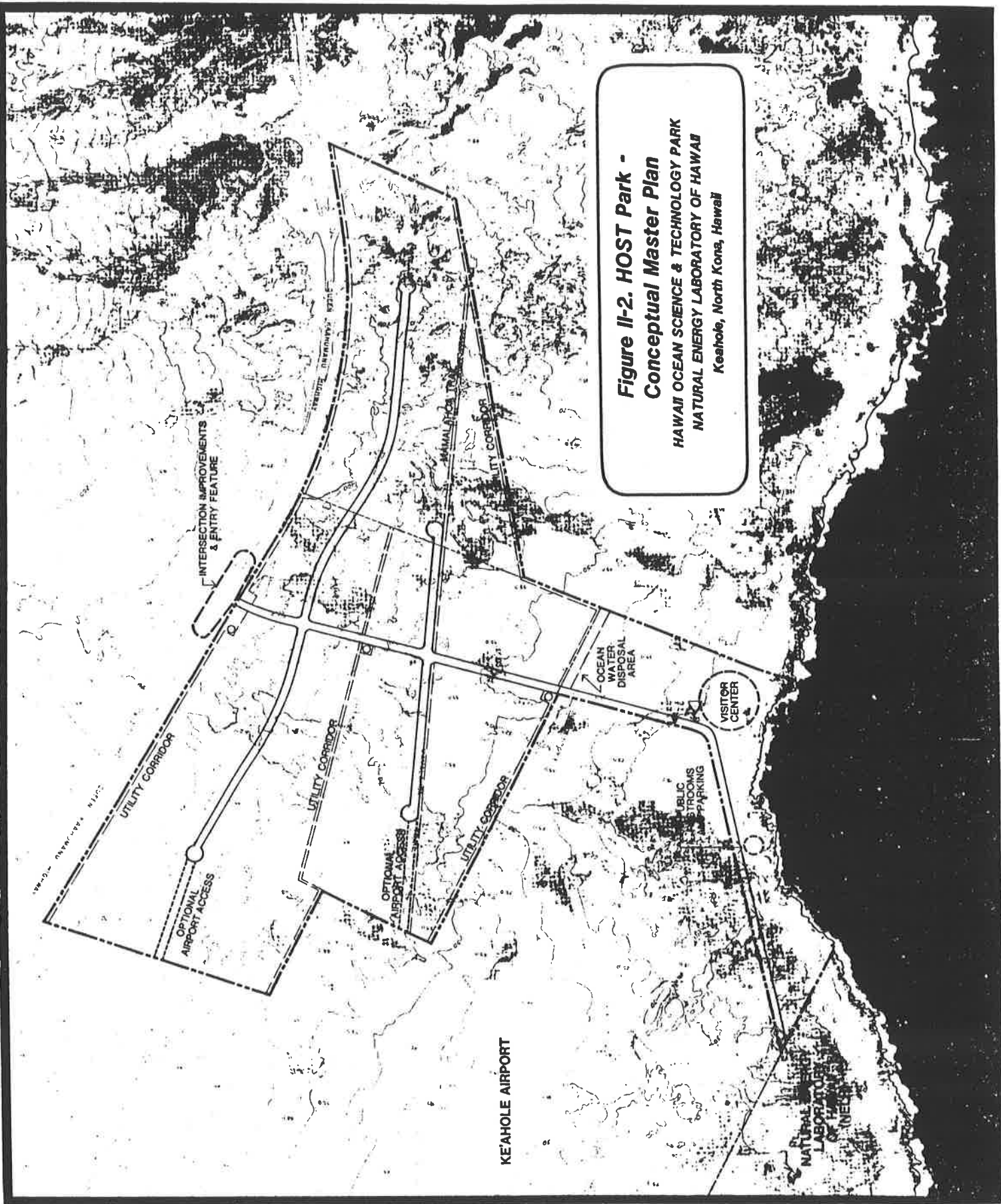

**Figure II-2. HOST Park -
 Conceptual Master Plan**
 HAWAII OCEAN SCIENCE & TECHNOLOGY PARK
 NATURAL ENERGY LABORATORY OF HAWAII
 Keahole, North Kona, Hawaii

- o An area for a future visitors' center and possible restaurant and/or oceanarium facility. The visitors' center would include a restaurant and possibly some service facilities for park tenants and their employees.
- o Improvements to the existing intersection at Queen Kaahumanu Highway to include the addition of left turn and acceleration/deceleration lanes.
- o Retention of the 24-foot wide pavement of the existing NELH access road and adding of graded shoulders to visually increase the width.
- o Construction of secondary roads to provide access to all tenant parcels within the park site.
- o Construction of underground utilities within the existing and proposed roadway rights-of-way including water lines, power and communications.
- o Extensive landscaping and a new entry feature or features at the highway intersection and provision for street trees down the central access road.
- o Construction and installation of a 48-inch cold-water intake pipe in the existing ocean corridor. The cold water to be pumped to the shoreline at Keahole Point and then transported in a large-diameter polyethylene pipe along the NELH access road. The first phase of the pipe to terminate in a head tank to be located just mauka of the airport boundary at approximately the 45-foot elevation.
- o Construction and installation of a warm ocean water intake pipe from the bay fronting the park into a pipeline paralleling the cold water system.
- o Provision of 25-foot wide utility easements at the back of all development parcels in order to provide space for pipes that will transport ocean water to individual tenant sites.
- o Designation of a central disposal area running parallel to the shoreline on the opposite side of the access road from the lowest cold water header tank.

A petition was filed with the Land Use Commission in March 1985 to reclassify the 547 acres of the HOST Park site from Conservation to Urban. This petition was based on the marketing and feasibility studies and master plan concept described above. Since that time, comments on the petition and the notice of preparation of the EIS for the project were received and discussions with various state and county agencies were held concerning various aspects of the plan as originally presented. As a result, it was determined that refinements to the concept were required in order to more fully disclose the implications of the project so that state and county agencies could make more informed decisions on the merits of the proposed development.

Because the actual firms who will locate in the park are still unknown, alternative development scenarios were constructed to illustrate the extremes of "what might happen" as the project develops. Basic to all of the scenarios are the following land use activities that are envisioned for the park:

- o Ocean-Water Commercial Use: Examples of this use are high intensity commercial mariculture, marine biotechnology, and renewable energy projects.
- o Campus Industrial Use: For example, scientific laboratories, educational facilities, and other uses such as desalination and renewable energy which do not necessarily use ocean water.
- o Service and Support Uses: For example, a visitor center/restaurant, light industrial uses (shops etc.), offices, refrigeration, and minimal warehousing and storage related to the primary activities on the site.

Other changes to the original concept include: replacement of the cul-de-sacs proposed for the internal road system with a looped road configuration; relocation of the visitor center to the upper portion of the site; and, at a minimum, pumping ocean water to the 80-foot elevation.

The assumptions of each scenario are described in sections 2.0 to 4.0 below. Basic to all scenarios is the initial improvements phase (FY 1985-86) if available funds are adequate. (Figure II-3). This includes:

- o Intersection improvements at Queen Kaahumanu Highway;
- o Construction of an entry feature at the intersection of Queen Kaahumanu Highway and the NELH access road;
- o Adding graded shoulders and landscaping to the existing NELH access roads;
- o Construction of stub roads;
- o Design and construction of underground utilities, e.g., water and electricity;
- o Design and construction of the first cold water intake pipe and associated pumps, overland piping and header tanks; and,
- o Construction of the initial sea water return flow disposal area.

2.0 Development Scenario A (Figure II-4)

2.1 Land Use/Activity Assumptions:

The basic assumption is that ocean water will be pumped to about the 110- to 115-foot elevation, and serve 83 percent of the site. Acreage assumptions by proposed activity are:

- o Campus Industrial/Service and Support: 78 acres, approximately 26 lots at minimum of 3 acres each.
- o Ocean Water Commercial Use: 385 acres, approximately 19 lots at a minimum 20 acres each.

NELH

KEAHOLE AIRPORT

Wawaioli
Beach

NELH Access
Road

Sea Water Return
Flow Disposal Area

Stub
Roads

Intersection
Improvements

1"=1,200'



**Figure II-3. HOST Park -
Phase 1 Plan**

HAWAII OCEAN SCIENCE & TECHNOLOGY PARK
NATURAL ENERGY LABORATORY OF HAWAII
Keahole, North Kona, Hawaii

QUEEN KAAHUMANU HIGHWAY

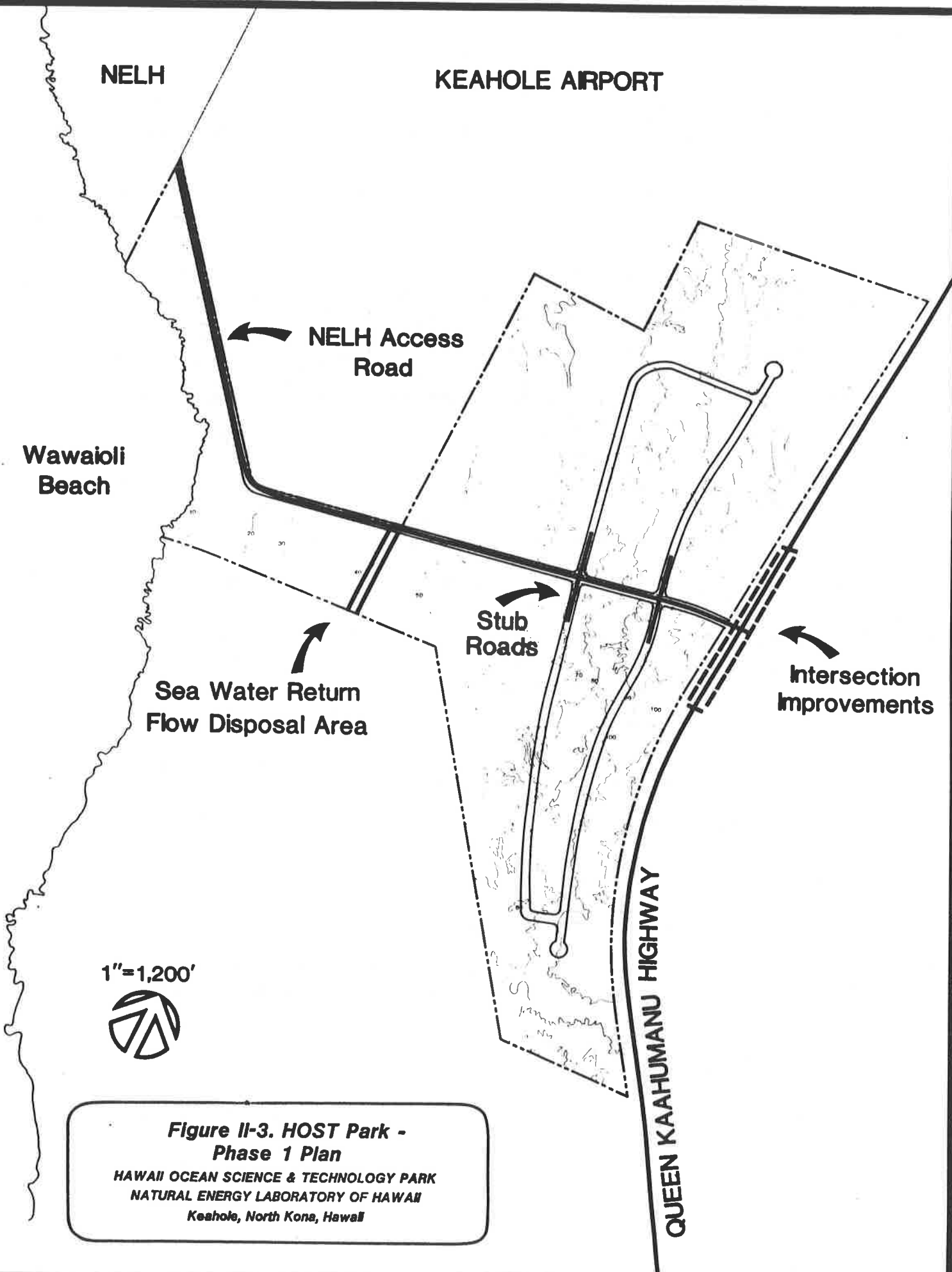

NELH

KEAHOLE AIRPORT

OCEAN WATER
COMMERCIAL USE
385 ± acres
19 lots at 20 ac. min.

CAMPUS
INDUSTRIAL/
SERVICE & SUPPORT
78 ± acres
26 lots at 3 ac. min.

1"=1,200'



**Figure II-4. HOST Park -
Development Scenario A**
HAWAII OCEAN SCIENCE & TECHNOLOGY PARK
NATURAL ENERGY LABORATORY OF HAWAII
Keahole, North Kona, Hawaii

2.2 Employment Assumptions:

Total on-site employment of 1,200 people at full development.

2.3 Infrastructure Assumptions:

- o Estimated potable water consumption of 120,000-144,000 gallons per day, average daily demand; 180,000-216,000 gpd, maximum daily demand.
- o Estimated domestic sewage generation of 60,000-84,000 gpd (average daily flow) into septic tanks.

2.4 Development Assumptions:

All lots committed within 5 years; full operation of park within 10 years; phased infrastructure (including pipes). Note: Visitor Center/Restaurant will most probably be developed in second phase.

3.0 Development Scenario B (Figure II-5)

3.1 Land Use/Activity Assumptions:

The basic assumption is that ocean-water would be pumped to the 100-foot elevation of the site (61 percent of the area). Acreage assumptions by proposed activity are:

- o Campus Industrial/Service and Support: 178 acres, approximately 59 lots at minimum of 3 acres each.
- o Ocean Water Commercial Use: 285 acres, approximately 14 lots at a minimum 20 acres each.

3.2 Employment Assumptions:

Total on-site employment of 2,100 people at full development.

3.3 Infrastructure Assumptions:

- o Estimated potable water consumption of 210,000-252,000 gpd, average daily demand; 315,000-378,000 gpd, maximum daily demand.
- o Estimated sewage generation of 105,000-143,000 gpd (average daily flow) into septic tanks/leach fields.

3.4 Development Assumptions

Full operation of park within 10 years; phased infrastructure (including pipes). Note: Visitor Center/Restaurant will most probably be developed in second phase.

NELH

KEAHOLE AIRPORT

OCEAN WATER
COMMERCIAL USE
285 ± acres
14 lots at 20 ac. min.

CAMPUS
INDUSTRIAL/
SERVICE & SUPPORT
178 ± acres
59 lots at 3 ac. min.

1"=1,200'



**Figure II-5. HOST Park -
Development Scenario B**
HAWAII OCEAN SCIENCE & TECHNOLOGY PARK
NATURAL ENERGY LABORATORY OF HAWAII
Keahole, North Kona, Hawaii

4.0 Development Scenario C (Figure II-6)

4.1 Land Use/Activity Assumptions:

The basic assumption is that ocean water would be pumped to the 80-foot elevation of the site (35 percent of the area). Acreage assumptions by proposed activity are:

- o Campus Industrial/Service and Support: 299 acres, approximately 100 lots at minimum of 3 acres each.
- o Ocean Water Commercial Use: 165 acres, approximately 8 lots at a minimum 20 acres each.

4.2 Employment Assumptions:

Total on-site employment of 3,190 people at full development.

4.3 Infrastructure Assumptions:

- o Estimated potable water consumption of 319,000-382,800 gpd, average daily demand; 478,500-574,200 gpd, maximum daily demand.
- o Estimated domestic sewage generation of 159,500-223,300 gpd (average daily flow) into septic tanks.

4.4 Development Assumptions

Full operation of park within 10 years; cold and warm water pipes to service entire development constructed in first 5 years; mariculture activities essentially in place and operational in first five year period. Note: Visitor Center/Restaurant will most probably be developed in second phase.

NELH

KEAHOLE AIRPORT

OCEAN WATER
COMMERCIAL USE
165 ± acres
8 lots at 20 ac. min.

CAMPUS
INDUSTRIAL/
SERVICE & SUPPORT
300 ± acres
99 lots at 3 ac. min.

1"=1,200'



**Figure II-6. HOST Park -
Development Scenario C**
HAWAII OCEAN SCIENCE & TECHNOLOGY PARK
NATURAL ENERGY LABORATORY OF HAWAII
Keahole, North Kona, Hawaii

Table 2-1 -- Summary of Research Projects at NELH

Project Name	Objectives	Sponsor Institutions	Dates	Status 6/84
Buoy Fouling & Corrosion Studies	Study fouling and corrosion of OTEC Heat Exchanger Materials	UHM, HNEI, JHU/APL	76-79	Completed
Mini-OTEC	Demonstrate net power production from OTEC	DPED, LMSC, Dillingham Corp.	1/79-12/79	Completed
Argonne Test Project	Heat transfer monitoring and biofouling control; Microfouling studies; Corrosion studies; Macrofouling studies; Water Quality Analysis	UHM/ANL NELH/ANL	7/81-present	Continuing
Simplex Corrosion	Measure corrosion of samples installed on offshore buoy	UHM	7/81-3/82	Completed
UH Atmospheric Corrosion Project	Monitor and analyze corrosion of samples in NELH marine atmosphere	HNEI	7/81-3/83	Completed
OTEC Aquaculture, Fish	Investigate parameters of growing salmon and trout in deep cold water	HIMB	1/82-11/84	Continuing
OTEC Aquaculture, Macroalgae	Demonstrate culture of nori (<i>Porphyra tenera</i>) and ogo (<i>Gracilaria</i> spp.)	HIMB	1/82-3/83	Completed
Abalone Culture	Investigate feasibility of commercial abalone culture in Hawaii	Hawaiian Abalone Farms	2/82-present	Continuing
OTEC Chlorination	Study the effects of low level chlorination on the marine food chain	UHM	6/82-6/83	Completed
Marine Lobster Culture	Validation of Hawaii as site for Northern Lobster (<i>Homarus americanus</i>) culture	Sanders Associates Inc.	9/82-10/83	Completed

Table 2-1 -- Summary of Research Projects at NELH (Cont'd)

<u>Project Name</u>	<u>Objectives</u>	<u>Sponsor Institutions</u>	<u>Dates</u>	<u>Status 6/84</u>
Cable Corrosion	Investigate corrosion of candidate materials for deep sea cables	Parson's Hawaii	1/83-present	Continuing
ASTM Corrosion	Monitor corrosion of metals in the ocean offshore of Keahole Point	ASTM	6/83-6/89	Continuing
Alcoa Corrosion	Study the corrosion of various aluminum alloys in flowing seawater	Alcoa	1/83-present	Continuing
Open-cycle OTEC				
Heat and Mass Transfer Research	Study efficiency of spout evaporation and condensers by measuring heat and mass transfer in seawater systems	UHM/HNEJ	6/83-present	Continuing
Gas Desorption Research	Use a packed column to study composition of dissolved gases in seawater heat and at various temperatures and pressures	UHM/Look Lab.	6/83-present	Continuing (to be combined with mass transfer study)
Mist-lift Process	Demonstrate operation of the mist-lift cycle with seawater	R & D Associates	6/83-12/83	On Hold
CWP/AST Phase III	Deploy and monitor 1/3 scale FRP CWP down slope off Keahole Point	HD&C/NOAA	4/83-5/84	Continuing

ANL Argonne National Laboratory
 DPED Department of Planning & Economic Development, State of Hawaii
 HD&C Hawaiian Dredging & Construction Co., A Dillingham Company
 HIMB Hawaii Institute of Marine Biology, UH Manoa (UHM)
 HNEJ Hawaii Natural Energy Institute at UH Manoa (UHM)
 JHU/APL Johns Hopkins University, Applied Physics Laboratory
 LMSC Lockheed Missiles and Space Company, Inc.
 NOAA National Oceanic and Atmospheric Administration

C. NELH DEVELOPMENT PLAN

1.0 Existing Conditions

NELH was established by the Hawaii State Legislature in 1974 as a facility for natural energy research and development. The site was chosen because of the nearby availability of cold, deep ocean water; a warm ocean surface layer not subject to strong seasonal cooling; high annual solar insolation; and, accessibility to logistical support through airports, harbors and highways. OTEC-related experiments have been conducted there since 1975. The official groundbreaking for the construction of permanent roads and facilities took place in January 1979.

NELH's first major onshore user was the Seacoast Test Facility (STF) Project. STF is a joint project of the State of Hawaii and the U.S. Department of Energy (DOE). STF is located on 5 acres near the tip of Keahole Point. Table 2-1 summarizes the Research Projects undertaken at NELH since the facility became operational.

Figure II-7 illustrates the existing land uses at NELH.

On-going Energy Projects

Energy projects at NEHL are selected according to their requirements for the natural resources available at the Keahole Hawaii site. These include the availability of deep cold and warm surface seawater and high solar radiation.

Much of the current research has been associated with OTEC systems and related research. A closed cycle OTEC experiment is in successful operation. Development of the pumping facilities necessary for the system involved much research into corrosion of pipes and cables in seawater, bio-fouling counter-measures, heat transfer, and water quality analysis.

Existing operational support facilities at NELH are primarily related to those needed for OTEC projects. Essential to these projects is the deep cold seawater supply. (Discussed in section D, below)

There is an extensive water quality laboratory to monitor flow, temperature, salinity, suspended solids, pH and alkalinity, nutrients, dissolved oxygen and residual chlorine. Environmental factors such as wind temperature and solar insolation are also monitored on a multi-channel data logger. There is also a PDP11-23 computer and an IBM-PC. Vehicles include 2 fork lifts, 3 trucks, an electric utility vehicle, station wagon and a 24 foot workboat.

Mariculture

Hawaiian Abalone Farms: The availability of high quality deep cold seawater also makes possible many types of aquaculture with considerable commercial potential. Hawaiian Abalone Farms (HAF), after 2 years of research at NELH which indicated the suitability of the deep cold water for abalone culture, has leased 21.3 acres on the NELH site and is currently operating a commercial demonstration module. Hawaiian Abalone Farms facilities include: 2 large million-gallon kelp tanks (each 15 feet high and 105 feet in diameter) and several acres of shade cloth structures covering abalone tanks. HAF is currently expanding its kelp growing capacity by

1"=1,200'



**Figure II-7. Existing Conditions -
NELH Site**
HAWAII OCEAN SCIENCE & TECHNOLOGY PARK
NATURAL ENERGY LABORATORY OF HAWAII
Keahole, North Kona, Hawaii

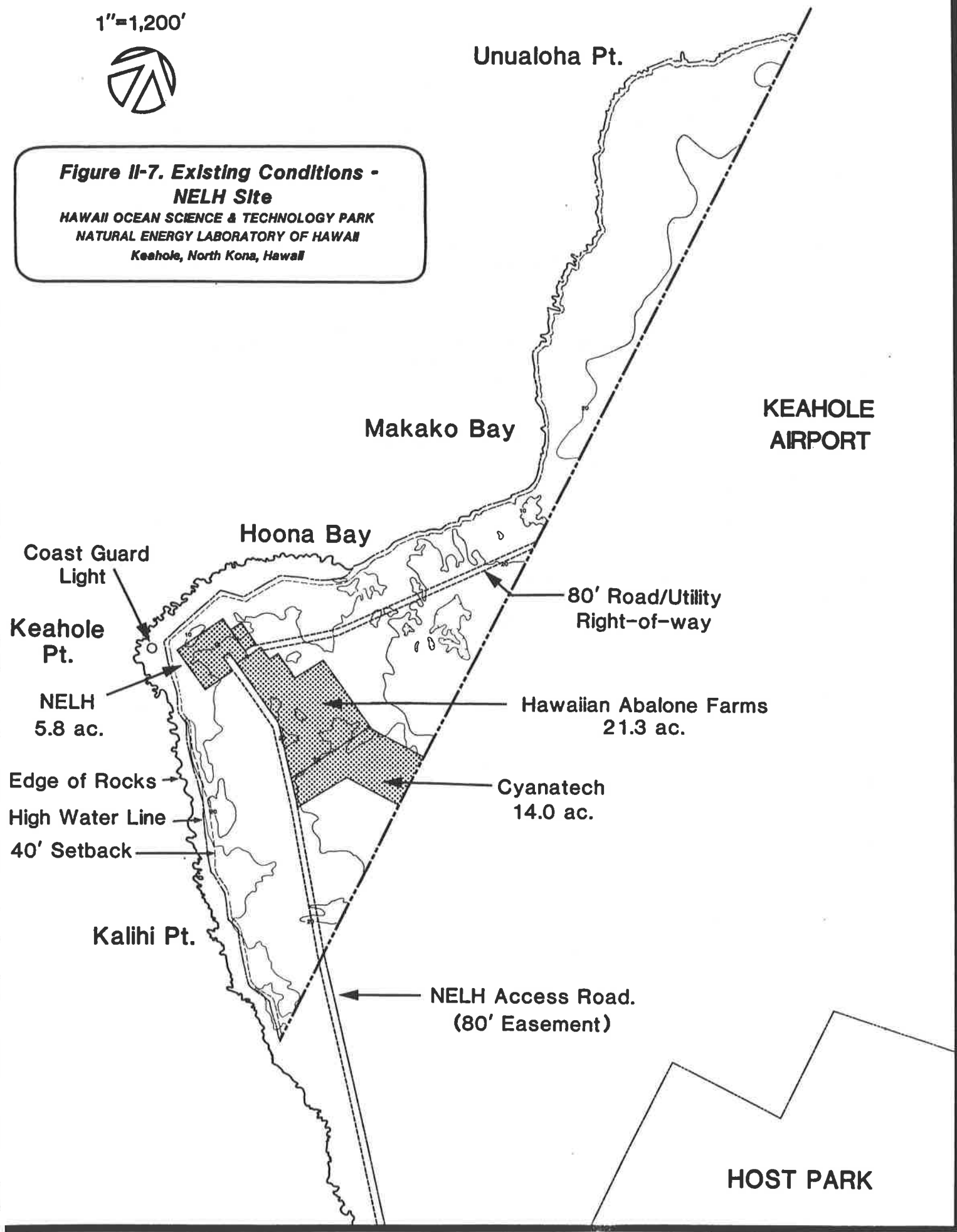

Unualoha Pt.

Makako Bay

KEAHOLE
AIRPORT

Hoona Bay

Coast Guard
Light

Keahole
Pt.

NELH
5.8 ac.

80' Road/Utility
Right-of-way

Hawaiian Abalone Farms
21.3 ac.

Edge of Rocks

High Water Line

40' Setback

Cyanatech
14.0 ac.

Kalihi Pt.

NELH Access Road.
(80' Easement)

HOST PARK

constructing 16 acres of 4-acre ponds. The company is in the process of installing its own 15-inch diameter cold water pipe which will supply 2,000 gpm of nutrient rich, pathogen free cold water. Another similar pipe is planned for installation in spring, 1986.

Cyanotech, Inc.: The company is currently developing production facilities at NELH for various marine microalgae. Their facilities, located on a 4-acre parcel adjacent to HAF, include lined raceways aerated by paddlewheels and a field house/processing facility where water is extracted and the algae is dried for packaging and shipment. Cyanotech will initially produce spirulina, a microalgae in great demand as a health food supplement. Although spirulina is normally grown in fresh water, the company scientists have demonstrated that it will grow in pure seawater. NELH has a commitment with Cyanotech to allow expansion to a total of 15 acres or more. The profit expected from spirulina sales will provide capital for the company's planned research into pharmaceutical derivatives, vitamins, food supplements and dyes from various microalgae.

Mariculture Research and Development: Facilities for mariculture research and development activities are located in the main laboratory compound. Aquaculture tanks, which are all plumbed with both warm and cold seawater, include: ten 600-gallon fiberglass tanks, five 100-gallon plastic lined steel tanks, ten 800-gallon tanks divided into one cubic meter sections, and various tanks, larval basins and growout baskets for the culture of Maine lobsters which are housed in a 1000 square foot inflatable building.

In this research area, where HAF first began, salmon and trout have been induced to spawn in seawater for the first time; experiments with Maine lobsters have been promising, and growing of kelp and algae has been accomplished. The condensed fresh water which forms on the cold water pipes has been used to grow strawberries of extremely high quality.

A giant clam project, using cold pure water, will shortly be under construction in the research portion of the compound. Initially it will use about 350 square feet of land, and will consist of shallow dirt ponds. The project is planned to be in the research stage one year, ultimately expanding to an area outside of the compound on a site of about three acres.

2.0 Planned Projects

2.1 Energy Projects

STF Upgrade Project: The U.S. Department of Energy and the state are currently in the planning and design phases of the STF upgrade project. Operations are planned to include:

- o a water system test facility for developmental research on open- and closed-cycle OTEC;
- o an expanded facility for experiments with OTEC-related mariculture; and
- o research experiments investigating the interaction of Ocean Energy (OE) facilities with the oceanic environment.

The purpose of the expanded test facility will be to support experimental research on critical elements of advanced OTEC systems such as: mist lift, spout evaporation, and other advanced system components. The facility will also be designed to support environmental, oceanographic and ocean engineering experiments to aid the development of diverse ocean energy supply operations. Up-grades to the facility will include:

- o Cold water, warm water and mixed seawater disposal pipes. (See Section D).
- o An experimental test facility to be located within the present laboratory property, occupying a space of approximately 2 acres;
- o Initial power, instrumentation, etc., by the present existing facility, although additional power and instrumentataion may be required in later parts of the program; and,
- o Four holding tanks (to maintain the appropriate pressures needed for the open-cycle experiment).

Alcan Aluminum, Ltd.: A large-scale test of aluminum heat exchanger elements. Several multi-tube heat exchangers of various alloys will be installed in the laboratory for continuous monitoring of heat transfer and corrosion with 6 ft/sec flow of both warm and cold water.

2.2 Planned or Projected Mariculture Projects at NELH:

- o Prospective mariculture projects in Maine lobster, shellfish and seaweeds are anticipated.

2.3 Other Uses

- o Materials Testing -- Corrosion, Biofouling, Atmospheric
- o DUMAND -- The DUMAND (Deep Underwater Muon and Neutrino Detection) project plans to deploy a large array of sensors in the deep ocean off Keahole Point in 1986. The power and data cables for the project will terminate at NELH, and plans are developing for a data collection and analysis facility at the laboratory. Instrumentation studies which were conducted off NELH have aided in the design of the complete system.
- o Direct Solar Energy -- Electric, Thermal
- o Solar Salt Gradient Ponds -- Solar Pond Ocean Thermal Energy Conversion (SPOTEC)
- o Desalination -- Direct, By-Product or Co-product
- o Marine Biomass Energy
- o Hydrogen from Seawater -- with Solar, OTEC energy source
- o Refrigeration and Cooling

- o Marine Systems and Equipment Testing
- o Agriculture -- Saline, Hydroponics
- o Manufacturing & Processing Systems -- Using Natural Resources
- o Miscellaneous Related Project Support Activities including: science, using the unique resources of the laboratory; personnel training; environmental studies; equipment storage; and project staging for submersible and research vessel cruises.

3.0 Development Scenario

The NELH Board has approved a development scenario which is based on the following policies:

- o Give highest priority to alternative energy projects.
- o Give preference to aquaculture projects that are cold water dependent but accept others if they can utilize resource (e.g. reuse water) and have potential for success.

Proposed land use allocations for the development scenario are illustrated in Figure II-8. For purposes of the EIS, maximum aquaculture was assumed when estimating the impacts of sea water return flows (worst case). Employment at full development was assumed to be 390 people.

Infrastructure Assumptions include:

- o Construction of a maintenance road to the northern sections of the site.
- o Estimated potable water consumption of 39,000-46,800 gpd, average daily demand; 58,500-70,200 gpd, maximum daily demand.
- o Upgrades to existing water distribution system when necessary.
- o Estimated domestic sewage generation of 19,500-27,300 gpd (average daily flow).
- o Construction of additional septic tanks when needed.
- o Expansion of laboratory buildings.

1"=1,200'



Figure II-8. Proposed NELH Development Plan
HAWAII OCEAN SCIENCE & TECHNOLOGY PARK
NATURAL ENERGY LABORATORY OF HAWAII
Keahole, North Kona, Hawaii

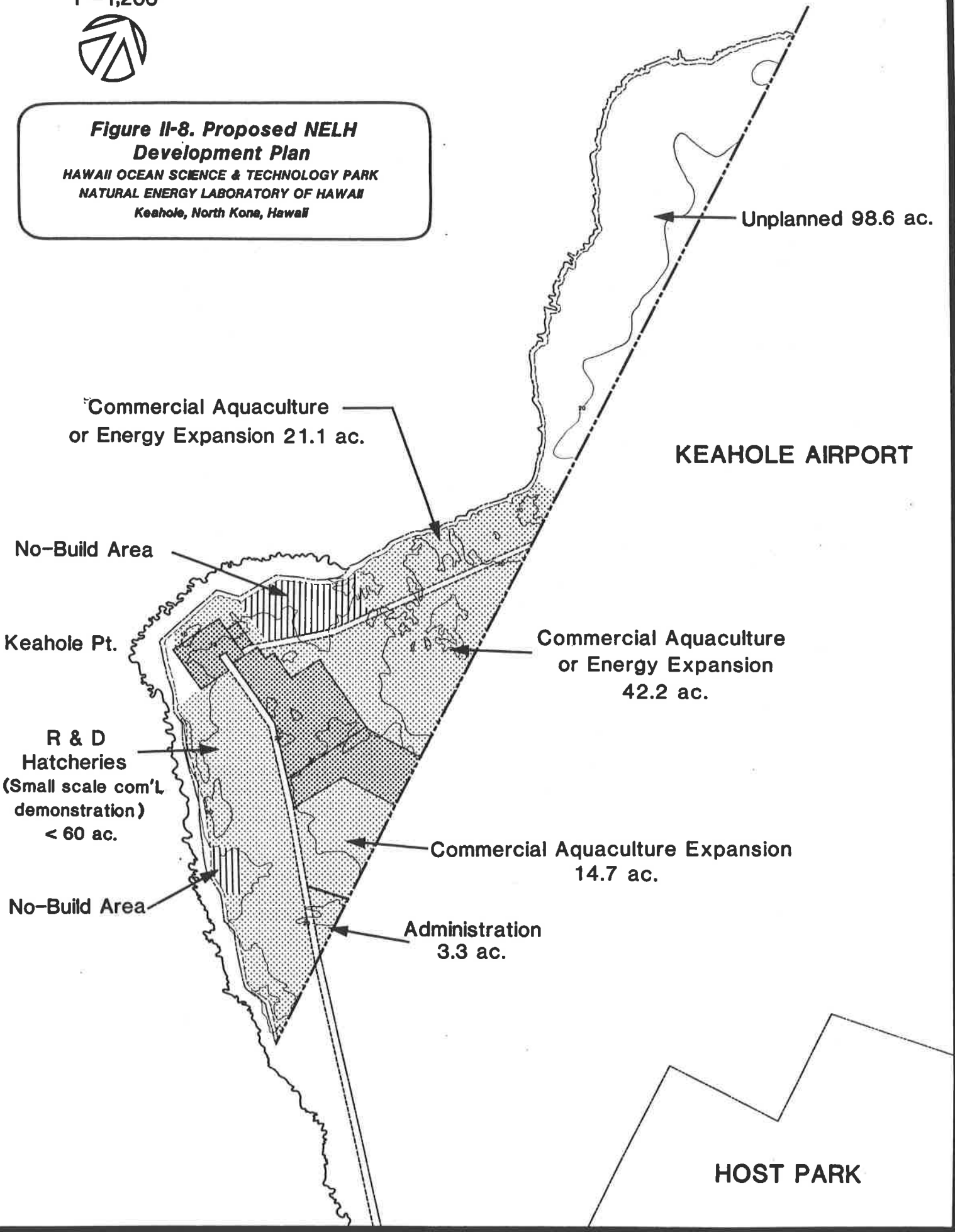

D. OCEAN USE CORRIDOR

1.0 Existing Conditions

The existing ocean research corridor (baseline data research area) is 1,000 feet wide and extends seaward in a westerly direction for approximately one mile offshore of Keahole Point Lighthouse (Figure II-9). Use of the corridor for research facilities (such as pipes, monitoring cables, etc.) was approved by the Board of Land and Natural Resources (BLNR) in 1977 (CDUA HA-11/8/76-879). Since 1982, construction of structures in the corridor has been covered under the U.S. Army Corps of Engineers Nationwide Permit for Scientific Structures. In 1977, the County of Hawaii approved a variance to the 40-foot shoreline setback for installation of cables from research instruments to shoreline and installation of temporary pipelines and pumps. Onshore construction of pipes and pumps is subject to the County of Hawaii SMA review process.

There are presently three 12-inch diameter ocean water intake pipes offshore Keahole Point serving NELH. These include 2 warm water intake pipes and 1 cold water pipe. All of the intake pipes terminate at the shoreline near the Keahole Point Lighthouse. The primary warm water intake draws water from approximately 30 feet below the water surface. The cold water pipe extends approximately 5,500 offshore to a water depth of approximately 2,000 feet (Figure II-10). The pumps for the cold water pipe are located offshore in water depth of about 25 feet. The pumps for the warm water pipes are located onshore at NELH. (These pipes were anticipated to be in place for only one year. They are still functioning after 3 years and will probably be left in place until larger pipes, such as the 30-inch DOE pipe, are operational).

In addition to the ocean water supply systems, a 75-foot long cold water pipe test section is situated offshore Keahole Point. This 8-foot diameter pipe section is located north of the intake pipelines on nearshore slope between approximately -75 and -125-feet deep. It was deployed for the purpose of demonstrating the installation of a large diameter cold water pipe on a steep slope and to measure the wave and current forces on such a large diameter pipe. The experiment has recently been terminated and the pipe will be removed sometime in the near future. The existing OTEC research pipeline systems within the corridor are described in detail by Noda & Associates in Appendix B.

A 15-inch cold water intake pipe is currently being installed within the ocean research corridor by Hawaiian Abalone Farms. The pumps will be located on shore and will deliver 2,000 gpm of cold water. An additional pipe of the same dimensions is anticipated to be deployed in spring 1986. These pipes are intended to be permanent. The HAF cold water system will also provide redundancy for NELH research projects.

It is estimated that three additional pipes could safely be accommodated within the sand channel offshore Keahole Point, which serves as the existing 12-inch cold water pipe route through an area of large basalt outcroppings and boulders. Any additional cold water pipes may need to be routed south of this area (and consequently south of the existing ocean research corridor) because of the increased risk of potential damage to the existing pipelines.

Figure II-10. Existing 12" Cold Water Pipe
 HAWAII OCEAN SCIENCE & TECHNOLOGY PARK
 NATURAL ENERGY LABORATORY OF HAWAII
 Keahole, North Kona, Hawaii

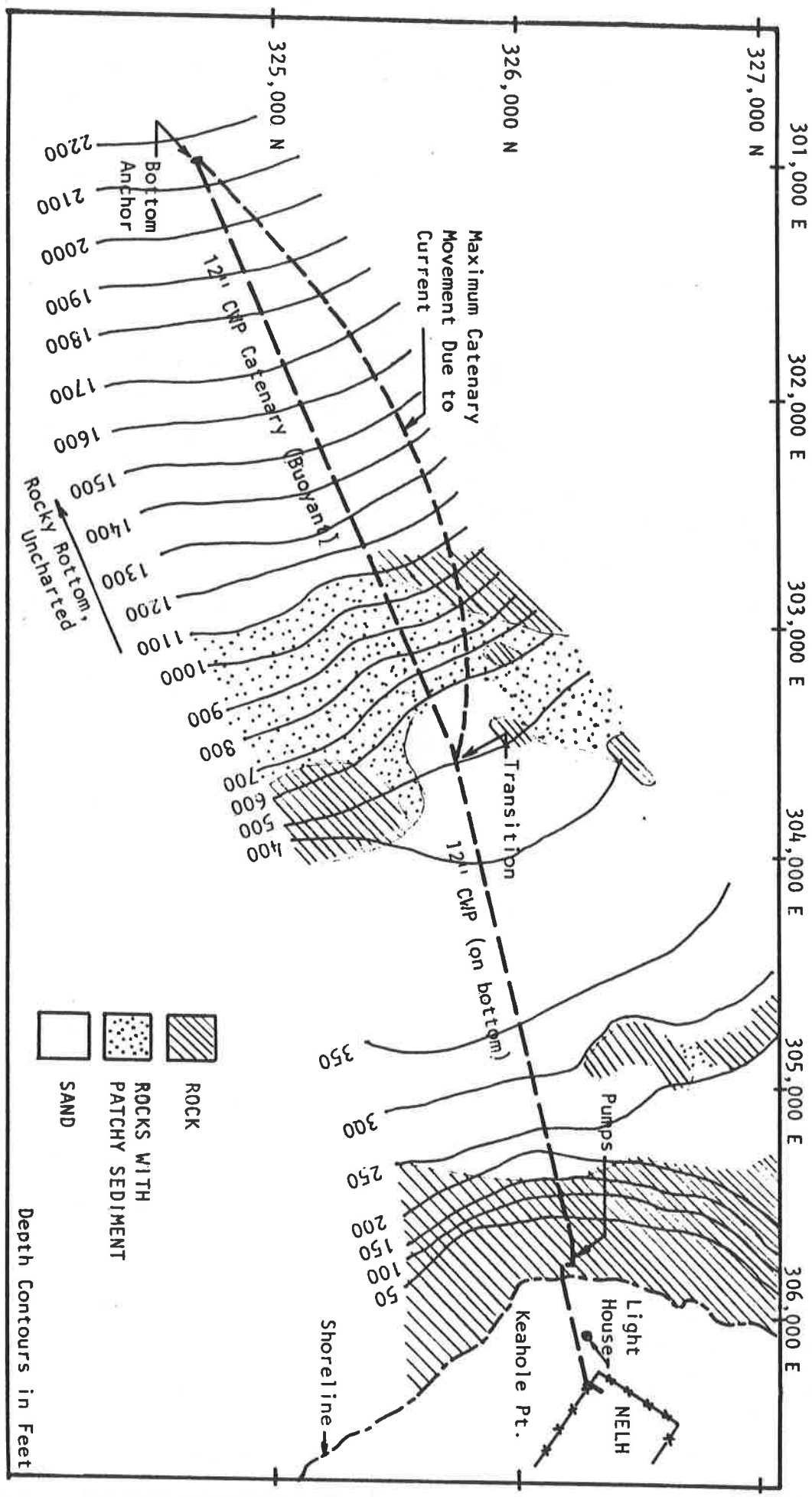

Depth Contours in Feet

2.0 Proposed Expansion of Ocean Use

A CDUA for an expanded Ocean Use Corridor that will allow permanent as well as temporary structures for both commercial and research purposes will be filed with the BLNR in fall 1985. This Master CDUA is intended to supersede CDUA HA-11/8/76-879 which limits the use to research activities and structures. It will describe, conceptually, all of the pipes projected for NELH and HOST Park at full development and specifically request permission to construct the initial HOST pipes and U.S. Department of Energy (DOE) cold water and warm water pipes and outfall. A process for approving each additional pipe will be developed in coordination and cooperation with Department of Land and Natural Resources (DLNR) and will be incorporated into the CDUA. Onshore construction of pipes and pumps is subject to the County of Hawaii SMA review process. Table 2-2 summarizes the projected pipes that may be located within the expanded corridor.

The primary technical considerations for establishing the boundaries of the expanded Ocean Research Corridor are the potential ocean water requirements for NELH and the HOST Park and the most cost efficient routing of the water to the users. Figure II-11 shows the present ocean research corridor offshore NELH and the proposed expanded corridor encompassing the NELH and HOST Park ocean frontage. The following discussion briefly summarizes the reasons for establishing the proposed northern, southern and offshore boundaries of the expanded corridor. A detailed discussion by Noda & Associates, Inc. is presented in Appendix B.

Northern Limit: A point 4,500 feet NE of the present northern corridor boundary is recommended for the northern limit of the expanded corridor. The deep water bottom contours offshore the site run in approximately a NNW-SSE alignment; the distance from shore to deep cold water (at least 2,000 ft. depth) increases substantially as one gets further north from the point. Although it is unlikely that any future cold water pipes will be sited beyond the present northern boundary of the ocean corridor, because the offshore length of cold water pipes must be minimized, it is probable that the most feasible and economical offshore locations for warm water pipes or ocean discharge pipes serving future users of the present NELH facilities would be north of the existing corridor.

Southern Limit: It is recommended that the southern limit be located at the southern property boundary of HOST Park at the coast. Although the distance from shore to deep cold water at the 2,000 foot depth increases slightly the further south one gets from Keahole Point, it is possible that detailed off-shore surveys may identify favorable routes for cold-water pipes in the area. Also, a warm water pipe system serving HOST Park would probably be located south of the Point to minimize onshore pipeline and pumping costs.

Offshore Limit: It is recommended that the offshore boundary limit be approximately 2 miles. The governing criteria for the minimum offshore limit is the need for sufficiently low ocean water temperatures for OTEC and cold water mariculture. This cold water source is available at nominal depths of 2,000 feet or more. In addition, potential future projects which may require the mooring of platforms or facilities offshore will need to be located sufficiently seaward of the cold water pipes to prevent interference with and possible damage to the pipelines. Therefore, the proposed offshore limit of the expanded ocean research use corridor should roughly parallel the deepwater contours at the approximate 700 fathom (4,200 foot) depth.

**Table 2-2 -- Description of Projected Pipelines
for NELH and HOST Park**
(with associated inflows/discharges in gpm)^a

Number	Conceptual Description	Inflow/Discharge (gpm)
1	30-inch cold water pipe	6,500 ^b
2	15-inch cold water pipes	4,000
2	24-inch cold water pipes	10,000
1	36-inch cold water pipe	12,000
1 - 4	Either 1 48-inch or 4 24-inch cold water pipe	20,000 ^c
1	30-inch warm water pipe	9,500 ^b
1 - 4	Undetermined size warm water pipes	80,000 ^d
<u>1</u>	48-inch deep ocean outfall	<u>(16,000)</u> ^b
Totals	10 - 16	142,000 gpm

^a gpm = gallons per minute

^b discharge volume accounted for by indicated cold water and warm water pipes

^c The areal requirements for either 1-48 inch pipe or 4 24-inch pipes are similar

^d The total demand for warm water is approximated.

Pipes will be constructed when and as required and the size will reflect the design volumes projected at that time.

Note: Required flow is the controlling factor in sizing pipes. The sizes listed above can only be considered estimates.

3.0 First Phase Construction

Noda & Associates describe the proposed DOE and HOST Park pipes in detail in Appendix B. Their findings are summarized in the following sections.

3.1 U.S. Department of Energy (DOE) Pipe

DOE's project needs are 6,500 gpm of cold water and 9,500 gpm of warm water. While the final design of this ocean water supply system has not been completed, the pipe sizes are estimated to be approximately 30-inch nominal diameter. The potential offshore pipeline route of the proposed DOE cold water and warm water intake pipes is within the existing ocean research corridor. A mixed water discharge pipe is also proposed to be located there. The pump stations would be located at the onshore terminus of the offshore pipelines and as close to the shoreline as practicable to minimize excavation costs. Figure II-12 schematically depicts a conceptual pump station which accommodates both the cold and warm water pipes, as well as the mixed water discharge pipe.

3.2 HOST Pipes

The anticipated ocean water flow requirements for HOST Park at full development are presently estimated to be about 20,000 gpm of cold water and 80,000 gpm of warm water, based on the initial marketing and feasibility study (Helber, Hastert, Van Horn & Kimura, 1985). While future marketing, planning and detail design studies may modify the ocean water flow requirements, pipe sizes of 48-inch nominal diameter (possibly in increments of 24-inch diameter pipes) are envisioned for HOST Park warm and cold water requirements. The location at the shore for the pump stations and the overland routing of the pipe(s) will depend on tradeoffs between many factors including cost and reliability considerations.

Depending on the Master Plan and design studies, the ocean water flows may be phased according to the estimated tenant requirements.

Although preliminary studies recommended that the HOST cold water pipe be constructed in the existing NELH corridor, it is possible that detailed offshore surveys may identify a favorable route to suitably cold water depths south of Keahole Point. Depending on the selected cold water pipe route, the warm water pipe may not have the same terminus at the coast. For example, if the cold water pipe route off Keahole Point is selected, then it may be more cost effective to provide a separate warm water pump station closer to HOST Park due to savings in overland piping and pumping costs. Figure II-13 schematically describes the potential pump station locations and pipeline routes for the extreme northern and southern potential cold water pipe routes.

The pump stations would probably be constructed onshore with a deep, free surface sump, whereby the water is pumped from the sump rather than the pump being directly connected to the offshore suction pipe. An onshore station will provide for more convenient maintenance of the pumps, which is a necessary part of any commercial operation in order to maintain the continuous flow capability. Depending on the existing ground elevation, the pump stations could be constructed almost entirely below grade.

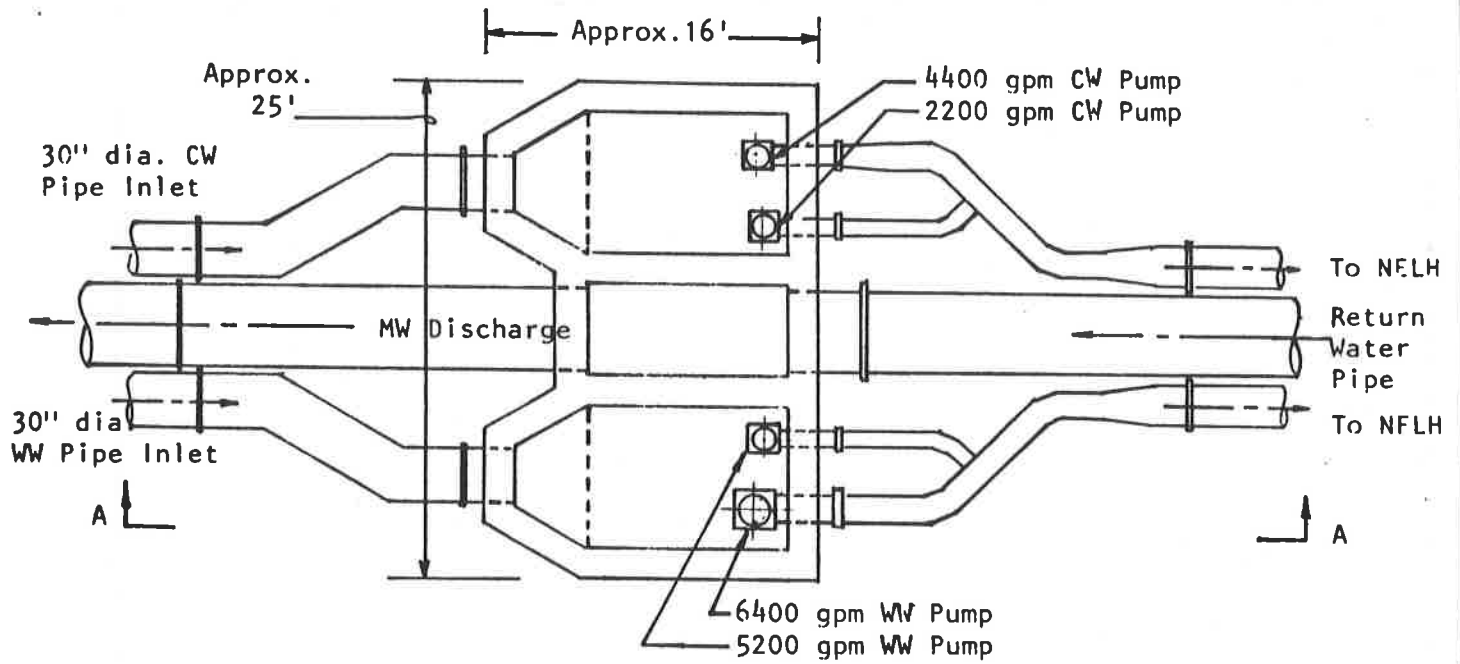

PLAN VIEW
Not To Scale

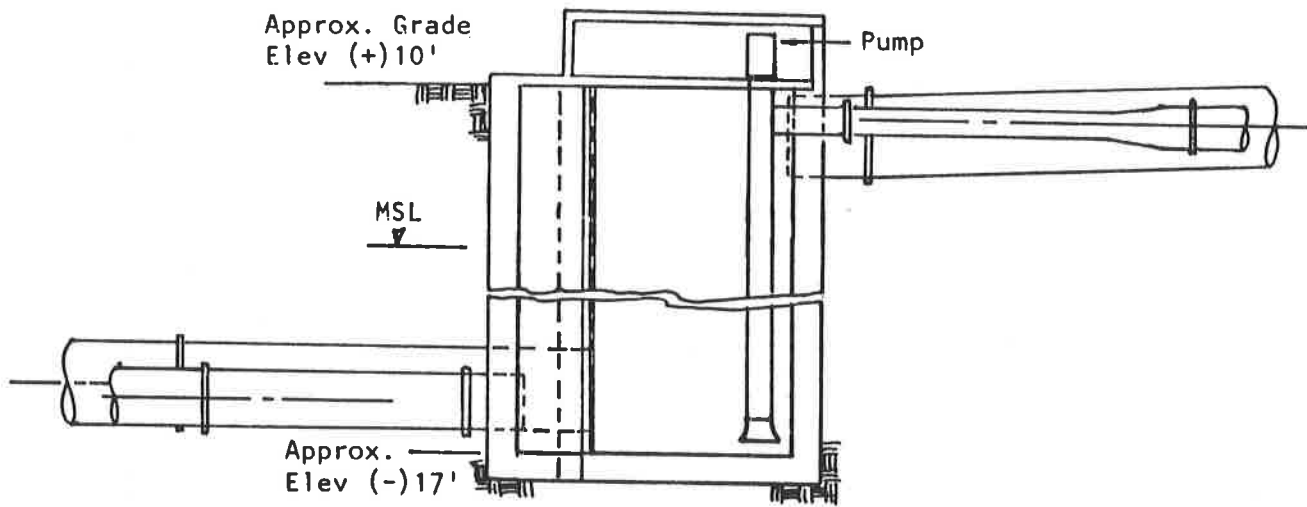

SECTION A-A
Not To Scale

Figure II-12. Conceptual Pump Station
HAWAII OCEAN SCIENCE & TECHNOLOGY PARK
NATURAL ENERGY LABORATORY OF HAWAII
Keahole, North Kona, Hawaii

PART III: THE PROJECT SETTING

A. THE REGION

The island of Hawaii is the most recently formed of the Hawaiian Islands. Commonly referred to as the Big Island, it has nearly twice the combined land area of all of the other islands in the state combined (Figure III-1). Formed by five volcanoes, its area is still being expanded by volcanic eruptions. Mauna Kea, the highest of the five, rises 13,796 feet from the northerly part of the island; the Mauna Kea Observatory, with four major operating telescopes and two under construction, is located at its summit. The County of Hawaii encompasses the entire island.

The 1980 census estimates the Big Island's population at 92,053; 40 percent of the island's people reside in the county seat of Hilo. The fastest-growing districts of the island from 1970 to 1980 were North Kona (185 percent increase), Puna (128 percent increase) and South Kohala (99 percent increase) (DPED, 1983). North Kona and South Kohala are located in West Hawaii, the area experiencing the highest tourism growth.

Keahole Point, the westernmost portion of the island of Hawaii, is located in the North Kona District (Figure III-2). According to the 1980 Census, North Kona had a resident population of 13,748 people (DPED, 1983). The major urban center on the leeward side of the island, Kailua-Kona, is located in the District.

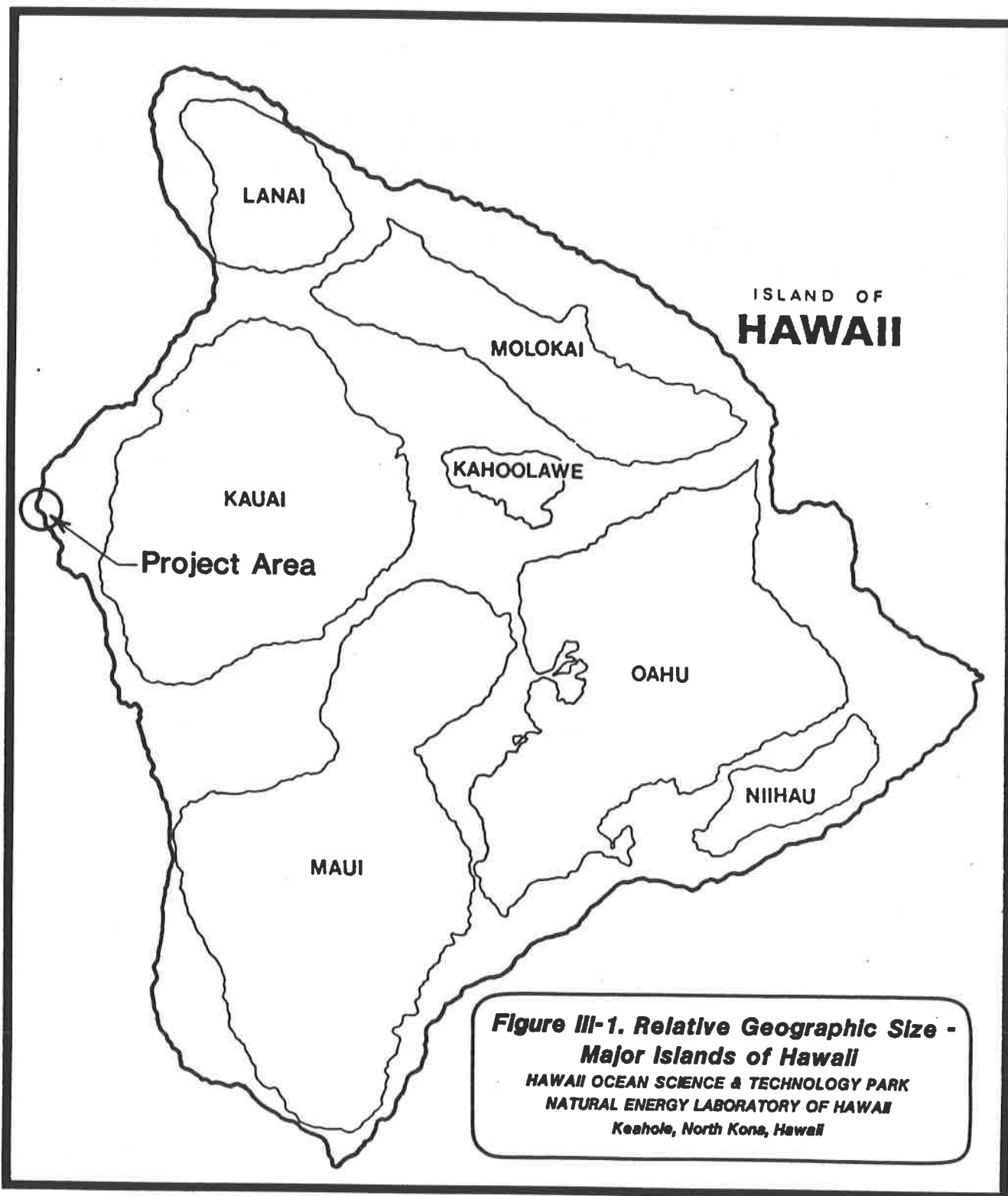

**Figure III-1. Relative Geographic Size -
Major Islands of Hawaii**
HAWAII OCEAN SCIENCE & TECHNOLOGY PARK
NATURAL ENERGY LABORATORY OF HAWAII
Keahole, North Kona, Hawaii

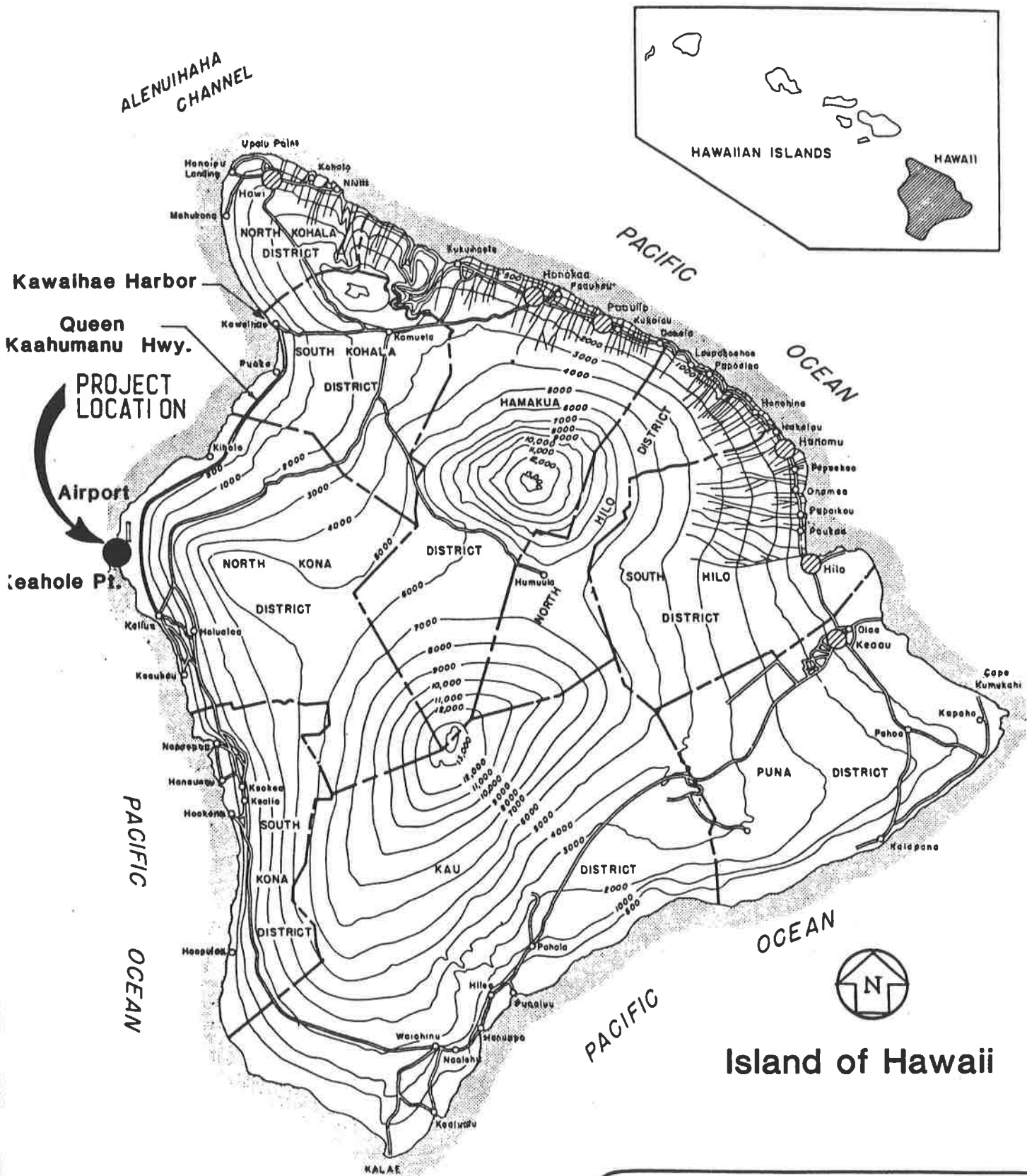

Figure III-2. Project Location
HAWAII OCEAN SCIENCE & TECHNOLOGY PARK
NATURAL ENERGY LABORATORY OF HAWAII
Keahole, North Kona, Hawaii

B. THE KEAHOLE AREA

The Keahole area is located on the western edge of Hualalai mountain and consists almost entirely of barren pahoehoe lava flows. The coastline is rocky and contains intermittent coral and basaltic (black) sand beaches, as well as basalt boulder beaches. The Hualalai volcano, although one of the oldest on the island of Hawaii, erupted as recently as 1800 to 1801 when the Kaupulehu lava flow reached to within 2,000 feet of Keahole Point. The 1800 to 1801 and previous visible flows have broken, rough surfaces transected by irregular vertical fractures. Lava tubes and other large openings, many of them collapsed, are common. (Dames & Moore, Appendix C)

The area, which could be affected by eruptions of Hualalai, is classified as risk zone DE (Mullineaux and Peterson, 1974); risk increasing from A through F. Lava flows have buried land in this area more recently than areas in zone D, but the frequency of Hualalai eruptions has been much less than Kilauea or Mauna Loa. Risk on Hualalai is rather poorly defined because of the sparse historic record. The area has also been identified as at risk from particle-and-gas clouds emanating from a Hualalai eruption.

All of the island of Hawaii is located in Earthquake Zone 3 (on a scale of 0-3 in the zone of highest seismic occurrence and danger). All construction work is subject to provisions of the "Uniform Building Code" which requires that all structures be designed and constructed to resist stresses.

Slopes in the HOST Park area average less than 5 percent, sloping downward from Queen Kaahumanu Highway (elevation approximately 120 feet) towards the ocean. The topography of the NELH site at Keahole Point is generally level and varies from sea level to approximately 20 feet MSL. In the lower elevations along the coastline, the land is relatively flat. The shoreline varies from level beaches to elevations up to 15 feet which drop steeply into the ocean to depths of 10 to 20 feet. The nearly vertical shoreline has numerous caves and lava tubes extending horizontally under the shoreline (R.M. Towill, 1976).

The U.S. Department of Agriculture Soil Conservation Service Soil Survey report for the area designates soil types as Aa (rLV) and Pahoehoe (rLW) lava flows. These lava flows have practically no soil covering and are bare of vegetation except for mosses, lichens, ferns and a few small ohia trees. According to the Land Study Bureau's Detailed Land Classification report for the island of Hawaii, the area is designated as class "E" lands. Class "E" lands are very poor or the least suited for agricultural uses.

The climate in the Keahole region is arid in the coastal area but changes gradually to humid in the Hualalai undissected upper slope. The average temperature at the Keahole Airport is 75 degrees F with a maximum recorded temperature of 89 degrees F and minimum of 54 degrees F. The area receives little tradewind rainfall; instead, much of the moisture is accounted for by orographic showers that form within sea breezes which move onshore and upslope. The mean annual rainfall ranges from less than 20 inches along the coast to as much as 75 inches on the lee of Hualalai crater (Dames & Moore, Appendix B). The wetter periods of the year

occur from May through September, which are usually the dry months of the year for the rest of the state.

Pan evaporation is typically high, in the general range of 0.18 inches per day for the winter and 0.36 inches per day for the summer as measured at Anaehoomalu. There is no pan evaporation measurement for the Keahole region.

The land masses of Mauna Loa, Mauna Kea and Hualalai block the prevailing northwest trades, and a land/sea breeze system predominates the area. The resulting winds are gentle offshore breezes during the night, switching to onshore during the day due to the heating of the land. Typical velocities range from 3 to 14 knots. The exception to this pattern occurs during the periods of so called "kona" weather during the winter months when low pressure fronts may cause strong southerly winds, in some instances approaching 30 to 40 knots (R.M. Towill, 1976).

Solar radiation at the site is constant, with the days cloud-free an estimated 95 percent of the year. The average daily total radiation on a horizontal surface is 2,019 BTU per square foot.

Three types of vegetation are recognized within the project area. They are:

Strand Vegetation: The strand or beach zone vegetation forms a narrow to somewhat wide (up to 300 ft. in width) belt along the coast. The substrate may consist of white sand or boulder and coral rubble deposited by storms. Clusters of naupaka (Scaevola taccada) shrubs are frequently encountered. A few scattered, windswept thickets of kiawe (Prosopis pallida) are occasionally found along the landward edge of the strand. Other species found along the shore include hi'aloa (Waltheria indica var. americana), beach morning glory (Ipomoea brasiliensis), Bermuda grass or manienie (Cynodon dactylon), and tree heliotrope (Messerschmidia argentea).

Vegetation on the 1801 flow: Vegetation on the 1801 pahoehoe lava flow is very sparse and scattered, most of the plants occurring along the edge of the flow. Plant species found on the flow include fountaingrass (Pennisetum setaceum), the native caper or maiapilo (Capparis sandwichiana var. zoharyi), swordfern (Nephrolepis multiflora), and hi'aloa. Where the flow meets the ocean, the shoreline consists of 5 to 20 ft. high sheet basalt cliffs (Nolan and Cheney, 1981) which are largely devoid of vegetation.

Dry grass-scrub community: This type of vegetation is found on the weathered, prehistoric flows composed principally of pahoehoe lava. It consists of a somewhat sparse cover of fountaingrass and scattered shrubs. Native shrubs and subshrubs found here include 'a'ali'i (Dodonaea viscosa), 'ilima (Sida fallax), naio (Myoporum sandwicense), alahe'e (Canthium odoratum), hi'aloa, and maiapilo; exotic shrubs include lantana (Lantana camara), indigo (Indigofera suffruticosa), klu (Acacia farnesiana), and Christmas berry (Schinus terebinthifolius). Noni (Morinda citrifolia), a Polynesian introduction, is also occasionally observed on the old lava flows. Weedy forbs, vines and grasses such as Australian vervain (Stachytarpheta australis), coatbuttons (Tridax procumbens), lauki (Cassia lechenaultiana), balsam apple (Momordica charantia var. pavel), Passiflora foetida, Japanese lovegrass (Eragrostis tenella), natal redtop (Rhynchelytrum repens), and pigweed (Portulaca

oleracea) may also occur here. A few scattered patches of swordfern can occasionally be found in cracks and crevices.

No rare, threatened or endangered plant species have been recorded in the project area. The native species that are found on the project site also occur in similar habitats throughout the West Hawaii area.

Because the project area is sparsely vegetated it supports a low concentration of wildlife. Most species are commonly found along the coastal zone or sometimes in the grass-scrub community on the old lava flows. Wildlife was rarely observed on the 1801 lava flow. A summary of past surveys of the area, prepared by Char & Associates, is appended to this EIS. Briefly, they report the following:

Two species of endemic Hawaiian birds are known to exist in the Keahole region: the endangered Hawaiian stilt, known to be present in pond areas several miles to the north and south of the site, may fly over the area; and, the Hawaiian Owl (Pueo) may feed on rodents in the area. The Hawaiian stilt prefers the pond areas north and south of the project site and the Hawaiian owl has a large home range over which it forages for rats and mice.

Other common, indigenous birds which have been observed in the area are the golden plover, wandering tattler, and ruddy turnstone, which are all found elsewhere in the world. Introduced species known to be present in the area include the Indian grey francolin, barred dove, common mynah, Japanese white-eye, house finch, house sparrow, cardinal, and Brazilian cardinal, among other species.

The Hawaiian hoary bat is the only endemic Hawaiian land mammal. It is found from sea level to 13,200-foot elevation and is known to occur in Kona (Tomich 1969). The bat probably feeds on insects along the coastal area of the project site during the evenings and night. The Indian mongoose was the only animal actually seen during a wildlife survey of the NELH site. The presence of other mammals, however, such as the common house mouse, roof rat, Polynesian rat, feral cats and goats was either indicated or suspected (Char & Associates, Appendix D).

The following summary of the history of the area was prepared by the Department of Anthropology, Bernice Pauahi Museum, from a review of historic documents, maps and literature sources. It appears as Appendix I in their most recent survey of the NELH site. (An Archaeological Reconnaissance of the Natural Energy Laboratory Hawaii (NELH) Property, Keahole Point, North Kona, Hawaii, Ms. 110784, October 1984.) The complete report is available for public review at OEQC, HTDC, NELH, UH Environmental Center, and selected libraries.

Keahole is the primary place name within this area and refers to the ahole fish (Kuhlia sandvicensis), a salt and fresh water fish considered a delicacy by Hawaiians. This fish had ceremonial functions in addition to being a food source (Pukui, Elbert, and Mookini 1974). The coastal waters around Keahole Point may have been a favorite area to catch the ahole fish.

Hamanamana, the name of one of the ahupua'a in the project area, is translated as "branching, forked" (Pukui and Elbert 1973), and may be

associated with the activity of lava flows in the area. The lava flow of 1801 has an interesting account recorded by Kamakau (1961), and was further researched and documented by Kelly (1971). This pertains to the destruction of the great fishpond Pai'aiea (located at Keahole) by the lava flow, and Kamehameha's attempt to calm the volcano goddess Pele's anger with some of the people living there. Only after Kamehameha and his kahuna offered sacrifices did the lava flow stop. By then, Pa'aiea pond was covered with lava. According to Kelly's account, this pond was quite large, extending from Keahole to Ka'elehuluhulu, a distance of nearly 5 miles. According to one account, people could paddle their canoes this distance and never have to leave the pond (Kelly 1971).

A somewhat isolated account from Kamakau that mentions Keahole Point is of questionable value, but nevertheless interesting: "The first taste that Kamehameha and his people had of rum was at Kailua in 1791 or perhaps a little earlier, brought in by Captain Maxwell. Kamehameha went out to the ship with (John) Young and (Isaac) Davis when it was sighted off Keahole Point and there they all drank rum. On his return it was evident to chiefs and people that he was acting strangely..."(Kamakau 1961:193).

Material pertaining to early land use for the project area is rather limited. The demonstrated prehistoric use of this area for fishing and other related activities seems to have continued into historic times and to the present. The barren nature of the landscape has certainly played a major role in restricting use for economic purposes....

Another possible reason for limited use in the past pertains to land ownership. The lands of Kalaoa (1-4) and 'O'oma were designated as lands belonging to and in control of the Hawaiian government at the time of the Mahele. Only one land court award was found on early maps. This is L.C.A. 7716 to Princess Ruth Ke'elikolani for an approximate 8-acres parcel in Hamanamana (Indices 1929). Two subsequent land grants are present. These include grant no. 1590 to Kauhini, in 1855, for 1,816 acres in Hamanamana, and grant no. 2972 to Kaapau and Kama, in 1864, for 515 acres in Kalaoa 5 (Index 1916).

Besides fishing, during most of the 1900s until around 1969, the project area and adjacent lands provided excellent goat hunting... (Clark, 1984).

C. THE PROJECT SITES

The proposed HOST Park and NELH properties at Keahole consist of government lands which include portions of the ahupua'a (land divisions) of Hamanamana, Kalaoa 1-4, Kalaoa-'O'oma, and 'O'oma 2nd. The State of Hawaii holds fee simple title to the properties. Title was acquired by the state as provided under Section 5(b) of the Admission Act (Act of March 18, 1959; Public Law 86-3, 73 State. 4). Portions of the property were set aside for Keahole Airport, to be under the control and management of the Department of Transportation (Airport Division) by Executive Order No. 2472, dated November 7, 1969. The remaining areas are under the control and management of the Department of Land and Natural Resources.

The HOST property is within Tax Map Key parcel 7-3-09:05 (Por.) and 7-3-48:03 (Por.). (Figure III-3) A portion of the site is within lands set aside under Governor's Executive Order No. 3074 to the Department of Transportation, Airport Division for Keahole Airport; this area within the Keahole Airport land is covered under a pending general lease to HTDC for ocean-related high technology industrial use. An additional area, TMK: 7-3-09: portion 05 (127.211 acres), which is under the jurisdiction of DLNR, is covered by Governor's Executive Order No. 3282 to HTDC; also for ocean-related high-tech industrial use.

NELH lies to the northwest of the HOST Park site immediately makai of the Keahole Airport Building Restriction Line. The NELH property consists of approximately 322 acres of state-owned land situated within Tax Map Key parcel 7-3-43: 3,4,5 (Figure III-3). NELH also utilizes approximately 121 acres of coastal waters and submerged lands, lying directly off of Keahole Point, for ocean research and baseline data collection activities (CDUA HA-11/8/76-879).

The State of Hawaii also holds fee simple title to the NELH property. It was originally part of lands set aside under Governor's Executive Order No. 3074 to the Department of Transportation, Airport Division, for Keahole Airport. The area is covered under a general lease with the BLNR.

The HOST Park property is situated within the State Land Use Conservation District as reflected on State Land Use District Map H-2 (Keahole). The majority of the site, the eastern (mauka) portion along Queen Kaahumanu Highway, is situated within the General subzone of the Conservation District; the more seaward portions of the site are currently in the Resource subzone.

The HTDC site abuts Urban and Conservation District lands to the north and Conservation District lands to the south, east and west. Agricultural District lands are located across Queen Kaahumanu Highway to the east, at the Keahole Agricultural Park (Figure III-4).

A lighthouse operated by the U.S. Coast Guard occupies the tip of Keahole Point. Keahole Airport lies east of NELH and north of the HOST Park site. HOST Park will be situated mauka of the normal flight pattern. The state's Keahole Agricultural Park lies east of the project area, mauka of Queen Kaahumanu Highway.

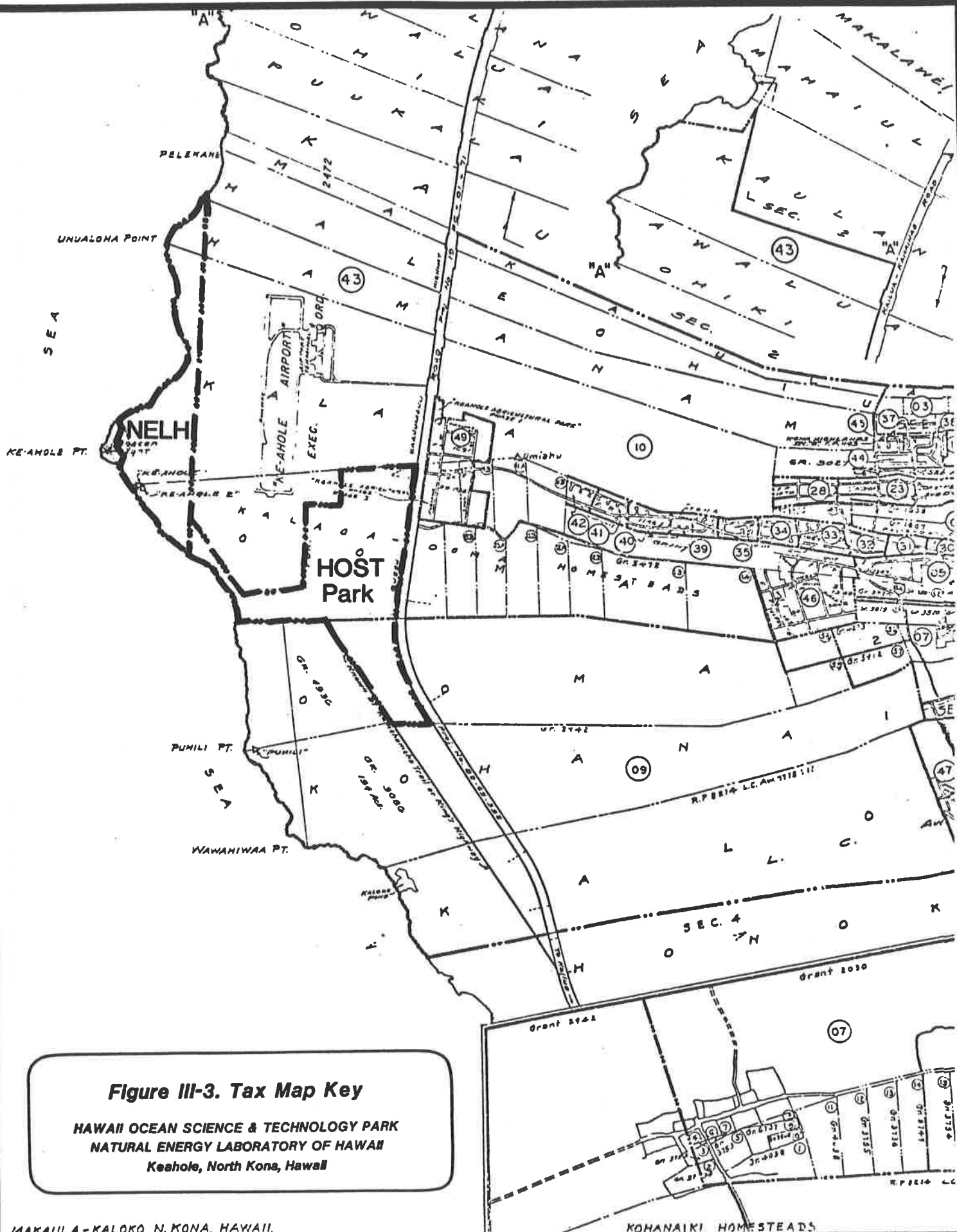
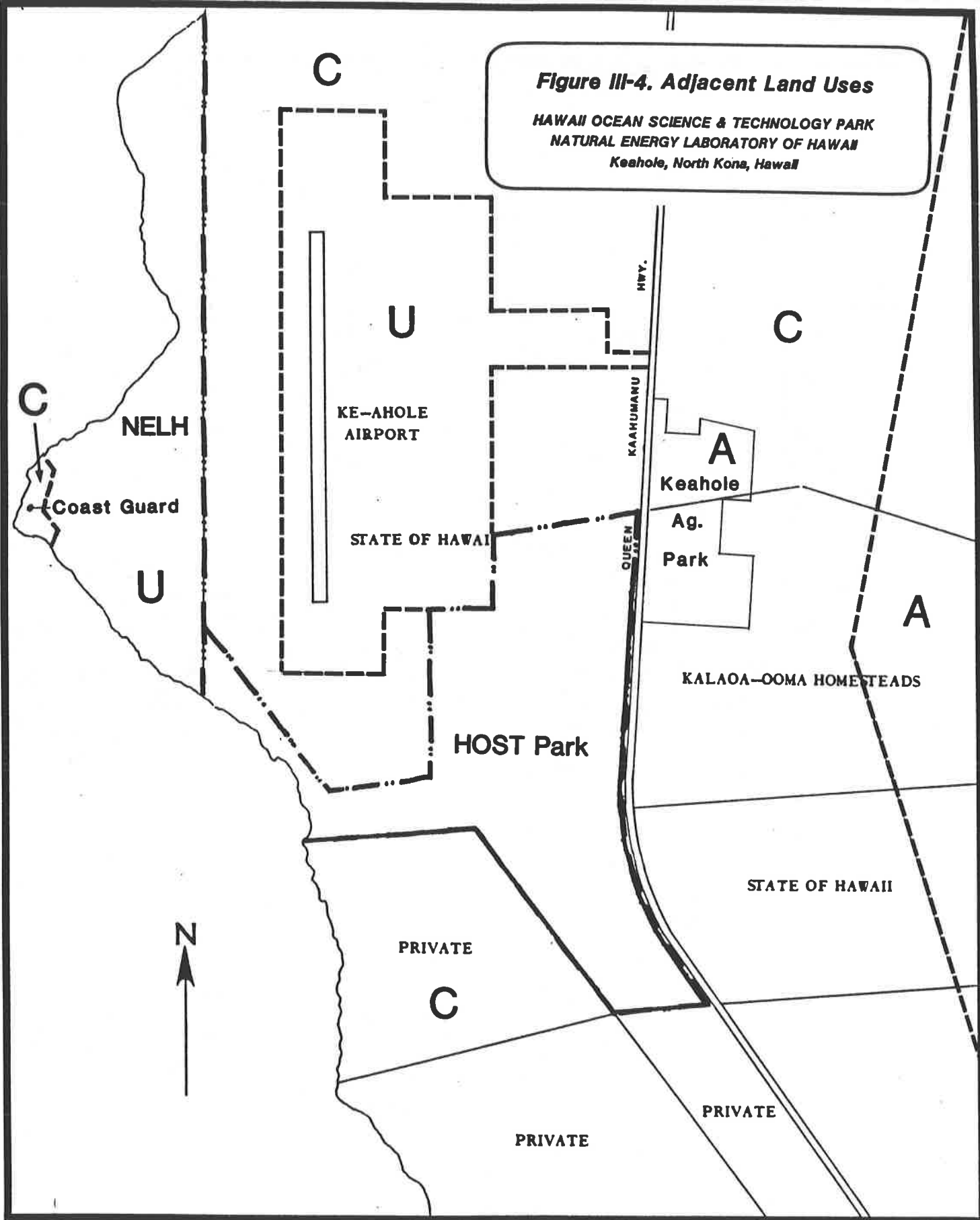

Figure III-3. Tax Map Key
HAWAII OCEAN SCIENCE & TECHNOLOGY PARK
NATURAL ENERGY LABORATORY OF HAWAII
Keahole, North Kona, Hawaii

Figure III-4. Adjacent Land Uses

**HAWAII OCEAN SCIENCE & TECHNOLOGY PARK
NATURAL ENERGY LABORATORY OF HAWAII
Keahole, North Kona, Hawaii**



The County of Hawaii General Plan Land Use Pattern Allocation Guide (LUPAG) Map designates the HOST property as "Industrial" and "Conservation"; the proposed use will not require a General Plan Amendment. The project site is zoned "Open" by the County of Hawaii and will require a zone change (anticipated to be to MG-3a) to accommodate the proposed HOST Park. The property is situated within the County of Hawaii's Special Management Area (SMA) and a SMA Use Permit will be required.

NELH is situated within the State Land Use Urban District as reflected on State Land Use District Map H-2 (Keahole). The County of Hawaii General Plan Land Use Pattern Allocation Guide (LUPAG) Map designates the property as "Industrial" and it is zoned MG-1a. The property is situated within the County of Hawaii's Special Management Area (SMA) and an amended SMA Use Permit will be required for future development.

There are important historic and prehistoric archaeological sites on both properties. The Mamalahoa Trail, also known as the King's Highway, bisects the property from north to south. The trail is currently impassable in many areas and has been completely obliterated by the Keahole Airport runway. Historical sites are discussed in detail in Part IV, Section E of this environmental impact statement.

D. THE MARINE ENVIRONMENT OF THE PROJECT AREA

Water depth increases rapidly with distance from the shore off Keahole Point, with depths of 2,500 feet within a mile of the coast. Between the 500 and 2,500 feet depths, the bottom slope is approximately 30 degrees. Shallower than 500 feet, the slope angle decreases. Passages of white sand up to 30 feet wide occur between basalt outcrops running perpendicular to the shoreline. Lava from the 1801 Hualalai flow is present in beds up to 20 feet thick, down to depths of 420 feet.

Currents offshore Keahole Point are dominated by two processes. Tidal oscillations drive reversing currents with diurnal and semi-diurnal periods. Typical maximal tidal current speeds are 3/4 to 1 knot. Tidal currents may be obscured for extended time periods by large-scale eddies propagated from the Alenuihaha Channel. An eddy off leeward Hawaii persisted and was tracked for 2 months (Lobel and Robinson, 1984).

Offshore surface currents range in speed from 10-37 cm/sec or, on average, less than half a knot (Bathen, 1975). Deep currents have been measured in the range 1-10 cm/sec (Bretschneider, 1978).

The wave climate of the Kona coast is typically characterized by two to four foot waves with periods of 9 to 15 seconds. Wave heights rarely exceed seven feet, except during the winter months. Larger waves are generated by local "kona" storms and distant storms in the north Pacific. The highest recorded wave along the west coast of Hawaii over the past 20-year period was 25.5 feet (R.M. Towill, 1976).

Sea surface temperatures in Hawaii vary relatively little annually or diurnally, ranging between 23-28.5 degrees C. (Gundersen, 1974). The wind-mixed surface layer extends 50 to 100 meters deep; the bottom of the thermocline may extend to 150 meters (OOME, 1981).

Scalar (nondirectional) irradiance in the photosynthetically active wavelengths (400-700 nm) has been measured through the water column offshore NELH (Noda, et al., 1980). The photic zone extends to about 125 meters.

The results of water chemistry analyses on samples collected offshore of the NELH facility indicate that salinity always increases with depth in nearshore waters. Offshore there is a peak concentration at 30-150 meters with low surface values and even lower concentrations at 150-200 meters. Salinity values are highly variable spatially and temporally, indicating large scale, rapid water mass mixing or movement (Walsh, 1985).

pH is maximal at the surface of the ocean due to the combined effect of carbon dioxide uptake and oxygen evolution in the photosynthetic process. Decomposition and respiration increase with depth, consuming oxygen and depressing pH. A pH minimum generally coincides with the oxygen minimum. (See Tables 2 and 3, Appendix F)

Oxygen concentrations range between 4.8 and 6.3 ml/l in a mixed layer extending to about 90 meters below the ocean surface. Surface layer concentrations are at

or above saturation values. A broad oxygen minima (1.0 ml/l) occurs between 450 and 900 meters (Noda, 1980).

Three distinct nutrient layers have been identified in offshore depth profiles (Noda, et al., 1980). In the mixed layer, concentrations are low and uniform, the result of uptake by phytoplankton. In the aphotic waters between about 150 and 400 meters there is a rapid increase in nutrient values caused by dissolution of particulate material from above and vertical diffusion. Maximal values are found below 600 meters.

In general, inshore nutrient concentrations are low, but consistently higher than in offshore waters (Walsh, 1985). Offshore transects show that when nearshore salinities are lowest, nutrients are highest, clearly reflecting shoreline seepage of nutrient-rich, brackish basal water.

Coastal waters near Keahole are classified AA by the Department of Health (Chapter 54, Water Quality Standards). "Wet" criteria apply due to the volume of groundwater seepage. Water classified AA are intended to remain as nearly as possible in their natural pristine state with a minimum alteration of water quality from any human-caused source or action. Offshore waters, beyond 100-fathom depths, are "oceanic," all Class A. The 1801 lava flow is a Class I, "protected reef community," sanctioned only for passive, non-consumptive uses. Other bottom areas, to 100-fathom depths, are Class II, "lava rock shorelines and solution benches."

Several studies (WRRC, 1980; R.M. Towill, 1982) have reported that coastal water quality standards are exceeded near the shore. This is not unusual since nutrient concentrations are generally elevated as a consequence of a high proportion of groundwater in very nearshore samples.

The benthic communities and marine biota of the Keahole area are described in Part IV, Section D.

PART IV: IMPACTS AND MITIGATING MEASURES

A. INTRODUCTION

Environmental impacts that might be generated by the proposed development could affect the immediate project area, the surrounding ocean environment, and other areas in the West Hawaii Region. These primary (direct) and secondary (indirect) impacts can be either positive or negative, short-term or long-term. Direct impacts are those which are related to the construction and operation of the facilities, while indirect impacts are those which may occur in other areas of the region as a result of on-going activities on the site.

The proposed projects will significantly change the land on the sites as a result of site clearance and new construction. Land transformation activities will occur during the pre-construction and construction phases of the project, a period which could take as long as 5-10 years to full development, in the case of HOST Park, and longer for the expanded research corridor.

The development of the new HOST Park, expanded NELH facilities, and expanded ocean corridor may result in permanent modification of certain environmental systems. Among these are drainage flows; hydrological systems; and the quality of the nearshore waters and its ecological balance. In addition, the operation of the new and expanded facilities, and the resulting increased activity on the sites, will generate long-term secondary (indirect) impacts which could be either beneficial or adverse.

B. METHODOLOGY

1.0 Assessment Process

The method of environmental impact analysis utilized in the development scenario approach was to anticipate the "worst-case" condition under various assumptions, evaluate the potential impacts associated with each set of assumptions, and, where possible, determine thresholds which could, at some time in the future, trigger a reevaluation of the operation and the affected environment before the "worst-case" condition is reached. Recommendations for mitigating measures were then developed and alternative actions that could be taken under different sets of conditions were described.

The long-term environmental consequences of many actions, which are in the forefront of technological advancement, are unknown. Therefore, in several instances in this assessment, mathematical models were used to identify the degree of risk involved in undertaking a particular type of action and to predict appropriate thresholds where intervention should take place before irreversible harm is done to the environment. Modeling the effects of an action where the actual effects are unknown, although theoretical and based on stated assumptions of the behavior of a particular system, allows criteria to be developed that will enable the effects of the action to be monitored as development progresses. It also facilitates the formulation of recommendations for preventive measures to minimize risks.

In the environmental analysis of development scenarios, impacts that depend on specific land use layouts and/or facility designs and the infrastructure requirements associated with them are treated in a generalized fashion. Project specific impacts are evaluated only when actual characteristics of the operation are known; other activities are addressed in a generic sense, based on knowledge of the industry, the results of past research and/or planning studies for a particular operation or program, and experience of other operators in the field. For example, although actual pond size, configuration or amount of earth that will be removed at a particular aquaculture facility, or the exact proportion of chemicals and other substances that will be used in the operation, are not known, the types of potential impacts associated with the construction and operation of aquaculture facilities can be identified; their significance can be evaluated; and the cumulative effects of a number of such operations on the existing environmental systems can be assessed. Mitigating measures and alternative design solutions for all similar projects can then be proposed.

2.0 Impact-Producing Actions

A systems approach was used to identify and evaluate the complex and interrelated construction and operational impacts of the proposed developments. A specific action was analyzed in terms of its causal effect on a particular subsystem of the environment. The changes in the system that would occur as a direct result of the action were evaluated and the related subsystems that would be affected by the modification (or change) were identified. In this manner the interdependencies of the various subsystems were recognized and both direct and indirect effects of an action were addressed. Mitigating measures and monitoring criteria were then developed which considered all aspects of the affected environment, thus minimizing the probability of recommending measures to reduce or eliminate

impacts on one aspect of the environment that might intensify the adverse effects on another.

The projects were broken down into separate potential impact-producing actions and modifications. Each activity was analyzed in relation to how it would affect an identified system and its related subsystems; both direct and indirect impacts were considered. The impact assessment which follows is categorized into the following areas of concern:

- o Land Development and Changes in Land Use
- o Pipe Construction and Deployment
- o Sea Water Return Flow Disposal
- o Socio-Economic Factors
- o Socio-Cultural Attributes and Recreation Resources

C. IMPACTS OF LAND DEVELOPMENT AND CHANGES IN LAND USE

1.0 Overview

The approximately 547-acre Hawaii Ocean Science and Technology (HOST) Park site is vacant and unimproved, except for the 24-foot wide two-lane NELH access road. Frontage along the Queen Kaahumanu highway is approximately 8,700 feet with an average depth ranging from 1,200 to 3,400 feet.

The 322-acre Natural Energy Laboratory of Hawaii (NELH) site is situated in the vicinity of Keahole Point along the western coastline of Hawaii immediately makai of the Keahole Airport Building Restriction Line. Existing improvements at NELH are described in Part II of this EIS.

The HOST Park site and the undeveloped portions of NELH are characterized by a desert-like appearance with sparse, dry grasses and herbs providing the only color to the dark lava landscape. The areas along the beach have a more diverse plant life; no rare or endangered plants are known to be present on either site. A description and analysis of site vegetation, based on a literature search and discussions with individuals who have surveyed the area in the past, is appended to this EIS (Appendix D).

Two species of endemic Hawaiian birds are known to exist in the coastal region of the property, the endangered Hawaiian stilt and the Hawaiian owl. The Hawaiian hoary bat, Hawaii's only endangered mammal, may cruise the coastal areas in the early evening and night to feed (Appendix D).

Archaeological sites are located on both properties. See Section G of this chapter for a complete description of these sites and their significance.

The shorelines of both sites are used by the general public for various recreation activities including fishing; camping; and diving. A jeep trail runs along the coastal area of the site. Recreation resources of the project area and potential impacts from the proposed projects are discussed in detail in Section G and in Appendix F.

2.0 Development Actions and Impacts

Changes in the land use of the HOST Park site from an open conservation area to an urban ocean science research and technology park, and expansion of the current research and mariculture activities at NELH, will require substantial improvements on the land that will affect various aspects of the physical environment. Continuing activities of the proposed development will also have direct and indirect effects. The following sections describe the affected environment and/or system; briefly summarize proposed actions which may effect a specific aspect of the environment; and, discuss potential impacts and mitigating measures for each. The analysis is based on the development scenarios described in Part II of this EIS.

2.1 Water Supply and Distribution

2.1.1 Existing Conditions

Fresh water for the Kona area is supplied from deep groundwater sources by the County of Hawaii Department of Water Supply. The major municipal water sources

are wells at Kahaluu and Keeki, located more than 10 miles south of the proposed project. The county system includes a network of transmission and distribution water mains, pumping stations and storage tanks as shown in Figure IV-1. This system will supply the proposed HOST Park development and the needs of an expanded NELH.

A 12-inch diameter transmission main, located along Queen Kaahumanu Highway adjacent to the proposed HOST Park, conveys water from the Kahaluu water storage tanks to a 0.5 million gallon (MG) reservoir near the entrance to Keahole Airport. At NELH, fresh water for domestic use and fire protection is supplied via a 4-inch water line connected to this transmission main.

2.1.2 Proposed Actions

A water connection for the HOST Park will be made on the distribution pipe of the Keahole water tank. A transmission main from that point (near the Keahole Airport entrance) to the HOST Park will be constructed. A new domestic water line will be constructed underground along the NELH access road from the park entrance to proposed parcels on the lower portions of the site. If necessary, NELH can extend the system to its site. It is anticipated that freshwater will be used primarily for drinking, dishwashing, showers and occasional tank washing. Fire flow will be provided. Irrigation needs are undetermined because the amount and types of landscaping are unknown at the present time

Projected water use for the facilities is estimated to be as follows:

HOST Park Development Scenario A: It is estimated that the approximately 1200 employees assumed for full development under this scenario would use between 120,000 and 144,000 gpd (average daily demand) of fresh water; 180,000 to 216,000 gpd (maximum daily demand).

HOST Park Development Scenario B: The projected 2,100 employees would be expected to use between 210,000 and 252,000 gpd (average daily demand) of potable water; 315,000 to 378,000 gpd (maximum daily demand).

HOST Park Development Scenario C: Approximately 3,190 employees would be expected to use between 319,000 and 382,800 gpd (average daily demand) of fresh water; 478,500 to 574,200 gpd (maximum daily demand).

NELH: At full development, the projected 390 employees would be expected to use between 39,000 to 46,800 gpd (average daily demand) of fresh water.

2.1.3 Impacts and Mitigating Measures

The HTDC has received a water commitment from the County of Hawaii Department of Water Supply to supply HOST Park with a maximum daily flow of 400,000 gallons per day. This supply would be sufficient for both consumption and fireflow purposes under the development assumptions of Scenarios A and B. Based on projected usage under Scenario C assumptions, the commitment would not be adequate.

The capacity of the NELH 4-inch water line is about 200 to 400 gpm. At 200 gpm the line could supply 288,000 gpd. This should be adequate to supply domestic

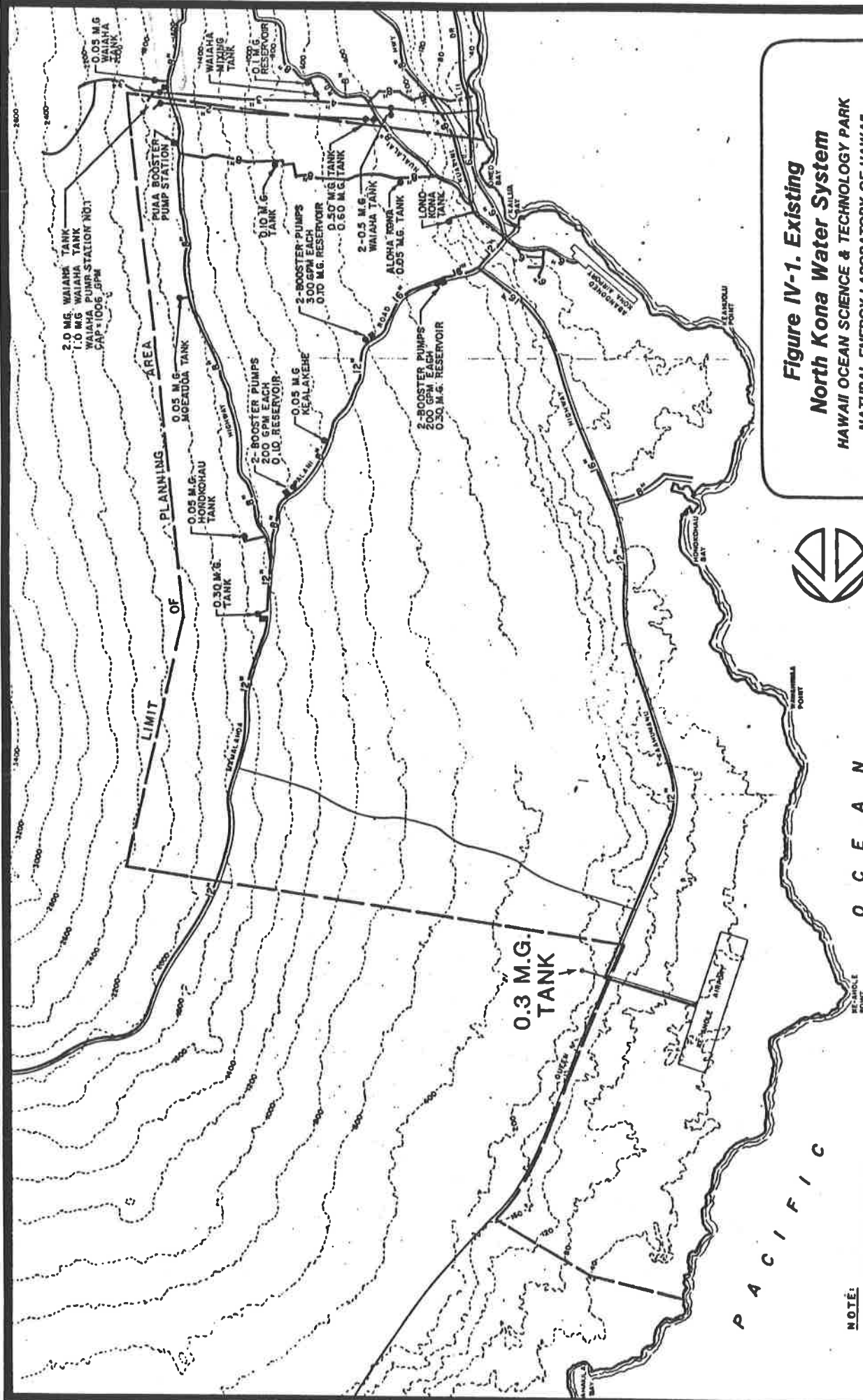

**Figure IV-1. Existing
North Kona Water System**
HAWAII OCEAN SCIENCE & TECHNOLOGY PARK
NATURAL ENERGY LABORATORY OF HAWAII
Kealahou, North Kona, Hawaii



PACIFIC OCEAN

NOTE:
DATA FROM DEPARTMENT OF
WATER SUPPLY, COUNTY OF
HAWAII.

consumption. Fire flow requirements dictate the need for construction of a longer line.

Water used for the proposed developments should not affect commitments to agriculture and other uses. The State of Hawaii has assisted the county in developing water resources in the Kona area and is expected to continue to do so.

Because Kona is a water short area at the present time, HTDC and NELH should monitor water usage of their tenants closely to insure that county commitments are not exceeded. Sub-leases and project agreements issued by both agencies should specify that water-saving fixtures should be used. In addition, both NELH and HOST should review all proposed projects and request potable water consumption demands so that the County of Hawaii commitments can be respected.

2.2 Sewerage

2.2.1 Existing Conditions

The nearest municipal sewer and sewage treatment plant is located in Kailua-Kona approximately 7 miles south of the project site. The latest county sewerage system expansion is being designed, and will include a 2.8 MGD wastewater treatment plant located near Honokohu Harbor about 5 miles south of the HOST site. The adjacent Keahole Airport has a 40,000 gpd extended aeration prefabricated sewage treatment plant.

The State of Hawaii Department of Health (DOH) regulations Chapter 57, Chapter 38 and Chapter 23 allow the construction of individual household treatment units in the HOST Park area. A central private sewage treatment facility is also allowed. Septic tanks are the method of disposal at NELH, with 4 such facilities currently available on the site.

2.2.2 Proposed Actions

Under the assumptions of HOST Scenario A, 1200 employees would be expected to generate between 60,000 and 84,000 gpd of domestic sewage. Under Scenario B, 2,100 employees, approximately 104,000 to 142,000 gpd is anticipated. The estimated amount of domestic sewage to be disposed of by the 3,190 employees assumed to be on site at full development of Scenario C is from 159,500 to 223,300 gpd. The 390 employees envisioned at full development of the NELH site would generate 19,000 to 27,300 gpd of sewage.

Several alternatives for sewerage were considered. They are:

- o Connection to the county's municipal system;
- o Connection to the Keahole Airport system;
- o Private centralized sewage treatment works on the site; and,
- o Individual wastewater systems.

The county does not plan to extend municipal sewers to the project area. Connection to the Keahole Airport wastewater treatment plant is not possible

11
C.
because the facilities do not have sufficient capacity to accommodate anticipated flows.

Individual sewage disposal systems comprised of septic tanks and leaching fields, meeting DOH requirements, are proposed as the means of providing some degree of wastewater treatment at the proposed HOST Park site. Projected densities are low and the number of such disposal units would be small. Additional septic tanks may also be required at NELH to service the needs of additional employees on the site. No cesspools will be allowed because of the higher groundwater contamination risks.

In the event that the higher density campus industrial and support services areas of the park make up the greatest proportion of the site, and when the restaurant and visitors' center are developed, a private sewage treatment plant to serve these particular areas can be considered.

Hazardous wastes will not be allowed to be disposed of in the septic tanks. Disposal of hazardous materials will be the responsibility of the individual tenant and shall conform to applicable Federal and State Hazardous Material/Waste regulations.

2.2.3 Impacts and Mitigating Measures

Septic tanks and seepage field units will be constructed as individual projects are developed. The utilization of well-designed, individual wastewater facilities of that kind will minimize the potentials for contaminating the groundwater. Planting of grass and shrubs above the leaching fields could enhance the beauty of the area and evapotranspiration from the plants could reduce the amount of sewage effluent that would reach the groundwater.

Any remaining sewage that is percolated down to the groundwater would be insignificant compared to the projected volume of ocean water disposal plume. (See Section E of this chapter for a description of ocean water disposal and its relationship to sewage disposal effects.)

2.3 Electrical Power

2.3.1 Existing Conditions

There are no electrical utilities at the HOST Park site. A 69-KV transmission line runs in a corridor along Queen Kaahumanu Highway fronting the project site; Hawaii Electric Light Company, Inc. (HELCO) has a substation mauka of Queen Kaahumanu Highway in the vicinity of the airport access road. Electrical power to NELH is supplied by a conduit running under the runway from the substation at the Keahole Airport to the makai airport boundary fence. Electrical power is distributed to the NELH facilities via an overhead 12.47 KV line running along a utility corridor from the makai airport boundary to the NELH power center in the main compound. Emergency power is supplied by three 125 KW diesel generators. The generators are built for intermittent use only and cannot be run dependably to provide baseload power. There is an automatic switching system to bring in the emergency generators when the grid power fails. The system is located within the NELH power center.

2.3.2 Proposed Actions

HTDC has requested permission from the State Department of Transportation (DOT) to allow HELCO to underbuild the existing 69-KV transmission line with a 12.47 KV distribution line running from its substation near the airport access road to the NELH/HOST access road an an existing substation near Kaloko. The separate overhead feeders from each of the substations will support the anticipated loads; however, improvements to the Keahole substation will be required.

If the request to underbuild is refused, a distribution substation consisting of concrete pads for transformers, switchgears and other pad mounted equipment, concrete foundations for steel structures and buses, and possibly a control building enclosed in a 100-foot by 100-foot area by an 8-foot high chain link fence will have to be constructed along Queen Kaahumanu Highway across from the NELH access road. In either case, a distribution line would then be fed underground across the highway to the project site.

From the access to the HOST property and throughout the site it is anticipated that all electrical lines will be buried in conduits in the same trenches as the domestic water line. These underground conduits will be installed to HELCO's specifications and will have a minimum separation between underground electrical conduits and the water lines. The airport has informed NELH that at sometime in the near future, they would have to be taken off their system. NELH proposes to connect to the new HOST system when it is completed.

Anticipated power usage at both facilities is projected to be between 10-12 MW at full development.

2.3.3 Impacts and Mitigating Measures

At the present time, the only feasible means of supplying the power required for the projected activities at NELH and HOST Park is connection to the HELCO grid. Although experiments in alternative energy are being conducted at NELH, the amount of electricity that can be produced is insignificant in comparison to total needs. At some time in the future, it may be possible to supply power for one tenant's operation from an on-site alternative energy source.

Either an underbuilt 12-47 KV distribution line or a new substation would be visible from Queen Kaahumanu Highway. A substation will require clearing of land and possible excavation and would be more costly and probably more visually intrusive than a distribution line on the same poles as the existing 69-KV transmission line.

Construction of the distribution line underground from the substation to the project site will probably disrupt traffic along Queen Kaahumanu Highway for short periods of time. On-site trenching for the underground conduits will be accomplished in conjunction with the installation of water and telephone lines. Upon completion, the underground installation will be more aesthetically pleasing than if power lines were constructed overhead on the project sites.

2.4 Drainage

2.4.1 Existing Conditions

No significant drainage patterns have been established in the region due to the relatively young age of the area, the light rainfall and the permeability of the lava itself. There are no perennial streams in the area; overland flows are negligible, except during severe storms when gulches may have heavy discharges.

Queen Kaahumanu Highway serves as a barrier between the higher Hualalai Mountain drainage areas and the lower coastal region of the proposed HOST Park. Drainage culverts convey excess storm runoff from the higher drainage basins across the Highway. A set of two-96 inch diameter corrugated metal pipe culverts cross the highway and discharge near the northeastern corner of the HOST site. The culverts were designed to accommodate 1251 cubic feet per second (cfs) stormflow (DOT drainage map).

2.4.2 Impacts and Mitigating Measures

An appropriately designed drainage channel may have to be constructed prior to the development of the north coast portions of the HOST Park site to safely handle discharges from the two existing 96-inch culverts. Drainage improvements allowing for seepage of storm flows into the ground are preferable to constructing a channel to the ocean. These improvements would probably occupy a fairly long and narrow strip of land. Culverts would be required at all road crossings and under the Mamalahoa Trail. The benefits of flood protection from storm water, which may be generated off-site and on-site, support construction of these improvements.

Due to the relatively large acreage within HOST Park, significant amounts of runoff could be generated, depending on the nature and type of improvements constructed. The pervious surface and subsurface soil conditions will help reduce the runoff. A system of swales, culverts, drains, catch basins and other drainage improvements will be provided to accommodate storm runoff generated within the project site. Local drainage from each lot can be handled with swales, ponding areas, seepage pits and other drainage improvements.

Due to the low annual rainfall in the region and the infrequent occurrences of large rain storms, the stormwater infiltration and any direct runoff are not expected to have a significant effect on water quality in this area.

Long term impacts include visibility of various drainage improvements and possible accumulation of debris in the channels and inlets. The large channel to handle flows from the 96-inch culverts would be visible from a distance. A beneficial impact will be the minimization of potential flooding of nearby lands.

Section E assesses the impacts of drainage on the coastal waters.

2.5 Access

2.5.1 Existing Conditions

Access to the project site is via a two-lane 24 foot-wide asphaltic concrete paved road with a 170 foot easement width. The road is approximately two miles long from its intersection with Queen Kaahumanu Highway to the NELH laboratory gate. There is no road to the northern portions of the NELH site and a jeep trail is the only other access to the coastal areas of the HOST and NELH sites. The Queen Kaahumanu Highway intersection is currently unimproved and direct right and left turns are allowed there. There is a guard house at the Queen Kaahumanu entrance to the site; however, it is rarely occupied. The gate at the highway is open during the day and closed at night.

2.5.2 Proposed Improvements

Suitably designed traffic control lanea will be provided at the intersection of Queen Kaahumanu Highway and the access road. Initial improvements to the main access road will involve grading of shoulders. Eventually, the road will be improved to Hawaii County standards. Branch roads for access to subdivided parcels will be paved with asphalt concrete.

Roads within the NELH site will be improved incrementally based on need for access. It is anticipated that the proposed road to northern portions of the site will function primarily as a maintenance road until subdivision of the area is required.

Impacts and Mitigating Measures

Roadways must be located, graded, paved and marked to permit access to each parcel. The roadway alignments must not result in new crossings of the historic Mamalahoa Trail. The trail must be protected and preserved. (Refer to Section E). The long term impacts will be physical and visual because the roadway will be used by vehicles for access to the parcels.

2.6 Traffic

A traffic assignment for the proposed projects was undertaken by Parsons Brinckerhoff. Their report is incorporated into this EIS as Appendix E. This report is summarized briefly in the following sub-sections:

2.6.1 Existing Conditions

Table 4-1 shows the existing traffic on Queen Kaahumanu Highway near the project site. The counts indicate good traffic conditions. No traffic counts were available for the NELH access road.

2.6.2 Proposed Improvements and Future Conditions

Proposed intersection improvements at Queen Kaahumanu Highway and the NELH access road envisioned in the development plan include:

- o acceleration and deceleration lanes to/from the southbound lanes of Queen Kaahumanu Highway;

TABLE 4-1 -- HIGHWAY TRAFFIC COUNTS

Queen Kaahumanu Highway

	<u>Southbound</u>	<u>Northbound</u>	<u>Total</u>
Daily - 1976	1594	1581	3175
1978	2304	2233	4537
1980	2107	2113	4220
1982	2707	2549	5256
1984	3484	3607	7091
<u>1984 Peak Hours</u>			
6:15 AM - 7:15 AM	146	337	483
10:00 AM - 11:00 AM	225	332	557
3:30 AM - 4:30 PM	365	229	594

Source: State of Hawaii, Department of Transportation, Highways Division. Count Station 8-P (A&B, South of Keahole Airport Road)

- o separate right and left turn lanes from the development (eastbound) to the highway; and,
- o a separate left turn lane to separate turning traffic from northbound Queen Kaahumanu Highway.

Traffic volumes on Queen Kaahumanu Highway are expected to increase considerably. Traffic volumes by 1991 without the proposed development are estimated to be 146 percent of the volumes counted in 1984; 1996 volumes are anticipated to be 178 percent of 1984 volumes.

Table 4-2 projects the increased traffic at the site which could be anticipated based on the assumptions used to define each scenario. Under the employment assumptions of Scenario A, daily traffic in 1996 could be expected to be 3820 vehicles per day (vpd) in and out; 795 during the peak hour. The forecast under Scenario B assumptions is an average daily traffic of 5980 vpd; 1245 in the peak hour. Traffic under Scenario C would be 8590 vehicles per day; 1790 during the peak hour. (Note: these scenarios are based on combined employment for HOST and NELH).

2.6.3 Impacts and Mitigating Measures

The analysis shows that under the employment assumptions developed for the EIS, traffic impact would be significant; an unsignalized intersection would not adequately serve peak hour traffic generated by the proposed development under any of the scenarios. Under Scenario C, this maximum would be expected to be reached by 1991. Additional turn lanes would have to be provided to serve the high volumes of turning traffic; these would require signalization for adequate control of the movements.

An alternative would be to distribute the peak entering and exiting traffic over two or more access points. For example, a connection to the Queen Kaahumanu Highway could be made about 0.5 miles south of the NELH access road. Maximum turning volumes at each entrance/exit are expected to be about 60 percent of those indicated in the analysis if this second connection is provided.

In the long term, if HOST Park and NELH reach the level of success projected in the scenarios, some form of mass transportation may have to be provided.

It should be noted that the scenarios were devised to illustrate "worst case" conditions and identify potential problems. It is uncertain at the present time as to how the development will actually progress. Traffic conditions should be monitored and future intersection improvements should be anticipated.

2.7 Communications

Hawaiian Telephone Company has an existing 3-inch conduit serving the NELH facilities. Additional lines will have to be provided to service the increased demands of the proposed project. These conduits can be installed in the same trenches as the electrical and water lines. There will be no additional environmental impacts as a result of the installation of these lines.

TABLE 4-2 -- TRIP GENERATION

	<u>Year</u>	<u>No. of Employees</u>	<u>Daily Traffic¹ In + Out</u>	<u>Peak Hour Traffic²</u>	
				<u>Peak</u>	<u>Opposite</u>
Scenario A	1991	1026	2460	462	51
	1996	1590	3820	716	79
Scenario B	1991	1451	3480	653	73
	1996	2490	5980	1120	125
Scenario C	1991	1966	4720	885	98
	1996	3580	8590	1611	179

1 - Vehicles per day, based on 2.4/employee

2 - Vehicles per hour, based on 0.45/employee peak direction and 0.05/employee opposite direction

2.8 Tsunami and Flood Hazards

Although Keahole Point is sheltered from the major tsunami generation centers for the Pacific (the Aleutians and Chile), more serious are the effects of local quakes such as the one occurring in Ka'u in 1868, reported to have been 7.5 on the Richter scale and to have generated a wave as high as 45 feet. Earthquakes are frequent in the Kona area; a quake of the magnitude of 5 was recorded west of Kona in 1972.

As shown by Cox (1982), the near-shore 100-year tsunami runup height in the Keahole area is estimated to be approximately 9.3 feet (See Environmental Center Comments on NOP, Part VIII); the Corps of Engineers estimate is 8.7 feet. Examination of flood insurance rate maps for the area indicates shoreline areas in zones V15 (areas of 100 year coastal flood with wave action; base flood elevations and flood hazard factors determined) and A4 (areas of 100 year flood; base flood elevations and flood hazards determined) (Figure IV-2).

2.8.1 Existing Conditions

Near the shoreline, tsunami inundation must be considered because of the low ground elevations. Tsunami and flood zones for the HOST Park and NELH properties are shown on Figures IV-3 and IV-4. The flood limits shown are for a 100-year tsunami.

2.8.2 Impacts and Mitigating Measures

The greatest impacts can be anticipated at the NELH site. It is recommended that no further structures which will house employees be constructed in the flood or tsunami areas.

No construction, except for pipes and pumps, will occur in the inundation zones of the HOST Park site. An exception may be a public restroom facility. Pipes and pumps will be designed to withstand design storm waves.

3.0 Construction of Improvements

3.1 Anticipated Construction Activities

It is anticipated that the actions described in section 2.0 for development of HOST Park and the expansion of NELH will require the following "on-land" construction activities. (Construction associated with pipes and ocean water disposal are discussed in Sections D and E, respectively.)

- o Construction of improvements to the existing intersection at Queen Kaahumanu Highway to include the addition of left turn and acceleration/deceleration lanes.
- o Grading of shoulders of the existing NELH access road.
- o Construction of secondary roads to provide access to all tenant parcels within the park site.

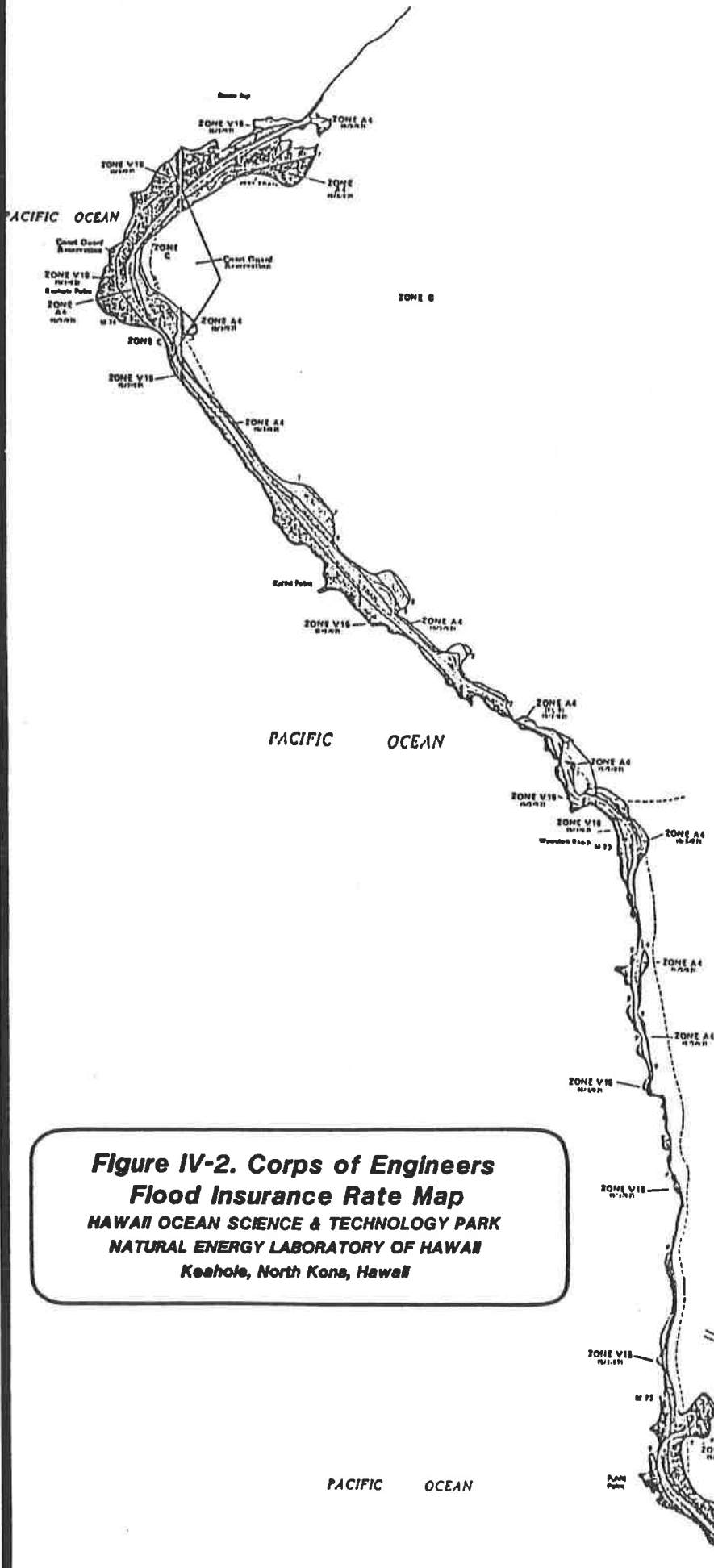

**Figure IV-2. Corps of Engineers
Flood Insurance Rate Map
HAWAII OCEAN SCIENCE & TECHNOLOGY PARK
NATURAL ENERGY LABORATORY OF HAWAII
Keeshole, North Kona, Hawaii**

Zone Designations* With Date of Identification e.g., 12/2/74	DATE ZONE A5 DATE
100-Year Flood Boundary	-----
500-Year Flood Boundary	-----
Base Flood Elevation Line With Elevation in Feet**	~~~~~ 513 ~~~~~
Base Flood Elevation in Feet Where Uniform Within Zone**	(EL 987)
Elevation Reference Mark	RM7 x
Coastline Mile	• M 20

***EXPLANATION OF ZONE DESIGNATIONS**

ZONE	EXPLANATION
A	Areas of 100-year flood; base flood elevations and flood hazard factors not determined.
A0	Areas of 100-year shallow flooding where depths are between one (1) and three (3) feet; average depths of inundation are shown, but no flood hazard factors are determined.
AH	Areas of 100-year shallow flooding where depths are between one (1) and three (3) feet; base flood elevations are shown, but no flood hazard factors are determined.
A1-A30	Areas of 100-year flood; base flood elevations and flood hazard factors determined.
A99	Areas of 100-year flood to be protected by flood protection system under construction; base flood elevations and flood hazard factors not determined.
B	Areas between limits of the 100-year flood and 500-year flood; or certain areas subject to 100-year flooding with average depths less than one (1) foot or where the contributing drainage area is less than one square mile; or areas protected by levees from the base flood. (Medium shading)
C	Areas of minimal flooding. (No shading)
D	Areas of undetermined, but possible, flood hazards
V	Areas of 100-year coastal flood with velocity (wave action); base flood elevations and flood hazard factors not determined.
V1-V30	Areas of 100-year coastal flood with velocity (wave action); base flood elevations and flood hazard factors determined.

NOTES TO USER

Certain areas not in the special flood hazard areas (zones A and V) may be protected by flood control structures.

This map is for flood insurance purposes only; it does not necessarily show all areas subject to flooding in the community or all planimetric features outside special flood hazard areas.

For adjoining map panels, see separately printed Index To Map Panels.

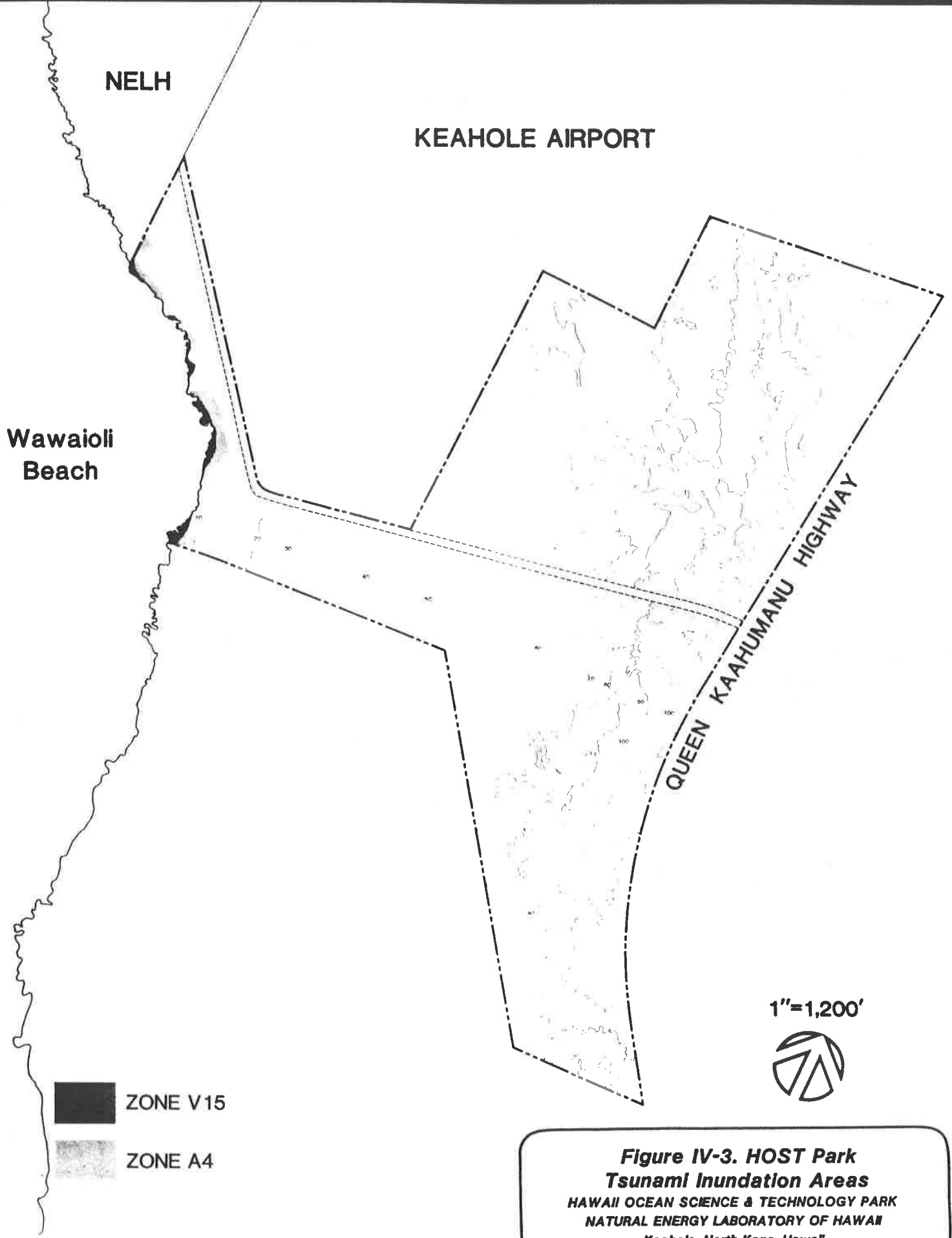

**Figure IV-3. HOST Park
Tsunami Inundation Areas**
 HAWAII OCEAN SCIENCE & TECHNOLOGY PARK
 NATURAL ENERGY LABORATORY OF HAWAII
 Keahole, North Kona, Hawaii

1"=1,200'



Unualoha Pt.

**Figure IV-4. NELH
Tsunami Inundation Areas**
HAWAII OCEAN SCIENCE & TECHNOLOGY PARK
NATURAL ENERGY LABORATORY OF HAWAII
Keahole, North Kona, Hawaii

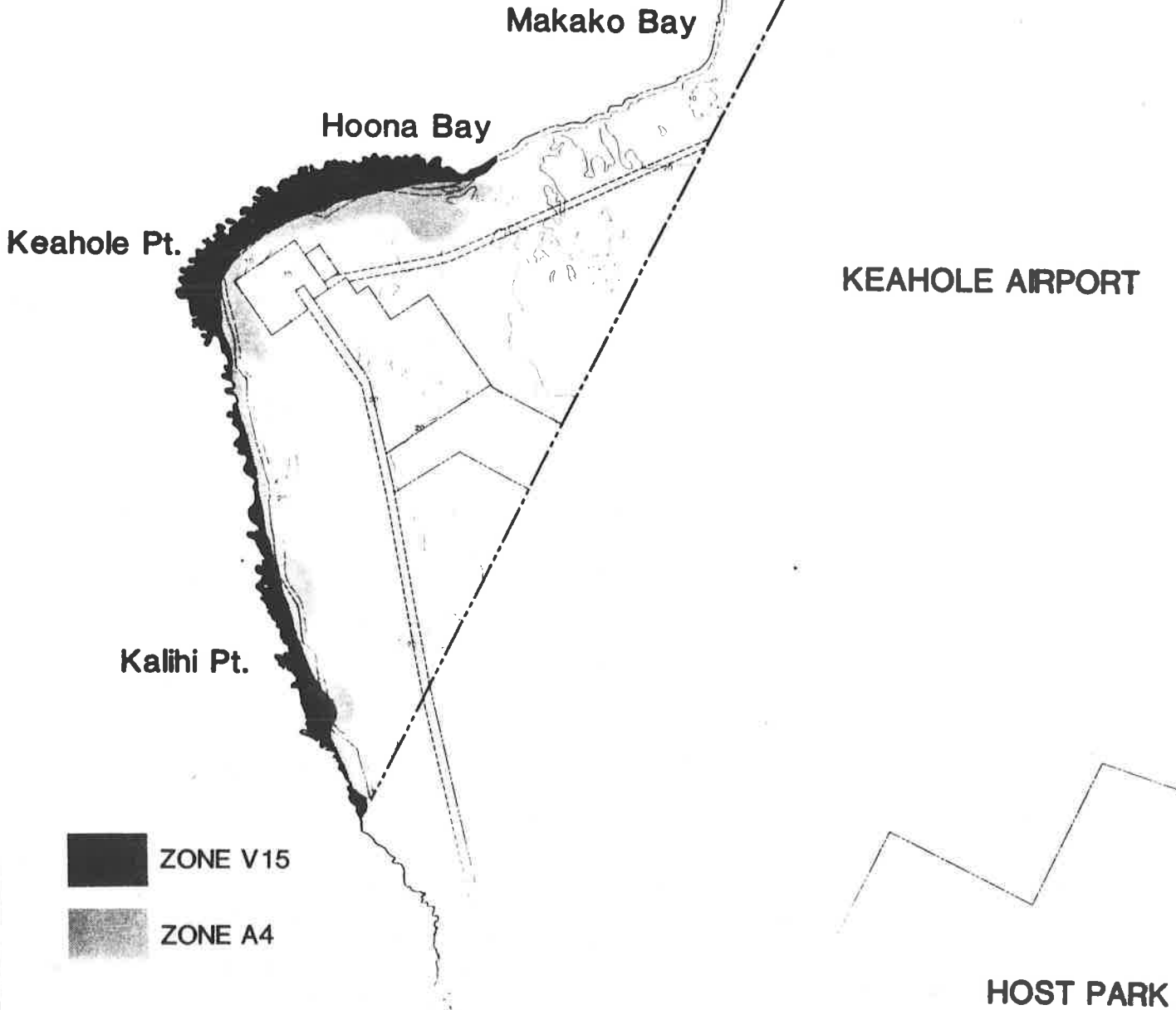

- o Construction of underground utilities within the existing and proposed roadway rights-of-way including water lines, power, communications and possible construction of a distribution substation across Queen Kaahumanu Highway from the project site.
- o Construction of trenches and barriers along the land route of HOST pipes from the pumps located in the coastal area to header tanks and installation of the pipes and tanks.
- o Construction of a trench for a sea water return flow disposal area.
- o Construction of drainage ditches and culverts.
- o Construction of ponds, raceways, buildings and paved parking areas.

3.2 Impacts and Mitigating Measures

Temporary construction related impacts include noise, increased dust and particulate matter in the air, and increased vehicular traffic along Queen Kaahumanu Highway. Blasting for channels may be necessary for drainage improvements. These impacts will be mitigated by existing governmental regulations which control noise, air quality and water quality.

Construction of the development will destroy vegetation on the sites. Vegetation in the area is generally sparse and scattered. No rare, threatened or endangered plant species have been recorded from the project area. Because the native species that are found on the project sites also occur in similar habitats throughout the West Hawaii area, the proposed developments will have minimal impact on the total island populations of the native components.

Construction of the proposed project will lead to the loss of habitat on land cleared of vegetation; however, the project area provides only a marginal habitat for birds and other animals.

Noise from blasting, drilling and other construction activities will probably disturb resident wildlife. This impact will be short term and intermittent. Because of its proximity to the airport the area is already noisy.

Some wildlife may be destroyed by construction activities, particularly invertebrates and introduced mammals.

Impacts on archaeological sites are addressed in Section G.

4.0 Secondary Impacts

The following secondary effects could result from the construction and operation of the proposed HOST Park and the expansion of NELH.

4.1 Anticipated Conditions

- o The presence of ponds, raceways, tanks, pipes, shade houses, buildings and parking areas in previously undeveloped areas.

- o The presence of up to 16 pipes and associated trenches and berms traversing the coastal areas of the properties and across the land.
- o The presence of pipes and associated pumps along the coastal areas of the properties.
- o Extensive landscaping and a new entry feature or features at the highway intersection and provision for street trees down the central access road.
- o Maintenance of landscaping and common areas of the two facilities.
- o The presence of sea water return flow disposal trenches at NELH and at HOST Park.
- o The presence of a 12.47-KV distribution line along Queen Kaahumanu Highway, which would be built under the existing 69-KV distribution line as a new substation on the highway across from the NELH access road, and associated transformers and other equipment.

4.2 Impacts and Mitigating Measures

The primary secondary impact will be the change in the visual appearance of the area from open space to areas with buildings, pipes, pumps, ponds etc. The wilderness character will disappear. Wherever possible, views to the ocean will be preserved. The area, however, is directly adjacent to the airport and thus the presence of urban structures would not be out of place. Design guidelines are being prepared to insure a consistent attractive development. FAA building requirements will insure lowrise construction (Department of Transportation, 1975).

The project will have no significant impact on endangered wildlife present in the project region. The Hawaiian stilt prefers the pond areas north and south of the project site; the stilt do fly over the site but will be unaffected by the project. The Hawaiian owl has a large home range over which it forages for rats and mice; the project will have a minimal effect on its total island population. The Hawaiian hoary bat is expected to be in the area while feeding in the air along the shore but will not be affected by the project.

One possible impact will be the effect of airport-generated noise on the employees of HOST Park and NELH. This can be mitigated by requiring each tenant to follow OSHA regulations for its employees. In addition, office space and laboratories can be designed to attenuate noise.

The possible attraction of birds to mariculture projects has been mentioned as a possible impact on adjacent airport operations. To date, birds have not been a problem at existing NELH projects because operations are under shade cloth or some other type of cover. Many mariculture operations aerate the water continuously, making the ponds less attractive to birds. The planned mariculture activities are sufficiently distant from the airport so that birds will probably not interfere with flight operations. If birds become a problem, ponds will be covered; not only because of aircraft operations but because the aquaculture operators need to protect themselves from losses.

D. PIPE CONSTRUCTION AND DEPLOYMENT

This Section is based on information provided by Edward K. Noda & Associates and G.K. & Associates. Their complete reports are incorporated into this EIS as Appendices B and F, respectively.

1.0 Existing and Proposed Pipelines

At present, three 12-inch diameter pipes supply ocean water to the NELH. A cold water pipe extends about a mile offshore to bring water from 2,000 feet depths. Below about 500 feet this pipe is buoyed above the bottom to avoid abrasion. Submersible pumps are located at about -25 feet. There are 2 warm water pipes; one is positioned at the base of the shoreline cliff in about 15 feet deep water, and the other extends about 300 feet offshore to water depths of about 80 feet and draws from about 30 feet below the surface.

The ocean water requirements of the HOST Park are estimated to be 20,000 gpm of cold water and 80,000 gpm of warm water. One 48-inch or up to four pipes of 24-inch diameter may be employed to bring water from a depth of 2000 feet. Warm water will be provided through pipelines into nearshore waters. A warm water pipe system serving the HOST Park would probably be located south of Keahole Point. Pipelines will either be buried or armored through the nearshore zone to protect them from wave forces.

The U.S. Department of Energy is planning to install a 30-inch cold water pipe and a 30-inch warm water pipe to supplement the 12-inch pipes at NELH. Water requirements are 6,500 gpm of cold water (from 2,000 feet) and 9,500 gpm of warm water (from 40 feet). Mixed seawater is to be returned to the ocean at a depth of 200 feet through a 48-inch pipe.

In addition to the 15-inch pipe to be installed this summer in the existing offshore research corridor, Hawaiian Abalone Farms (HAF) plans to deploy a second 15-inch pipe, two 24-inch pipes, and possibly a 36-inch pipe in the future, with total inflows of 26,000 gpm. One pump station will be constructed for all the planned pipes.

Table 2-2 summarizes the characteristics of the projected pipes.

2.0 Description of Coldwater Pipe Design and Location

OTEC and cold-water aquaculture pipelines intake locations must be in very deep water, typically in excess of 2,000 feet, in order to access the cold water resource. In the Keahole Point region, pipeline lengths of at least 6,000 feet or longer are needed to reach that depth. (Figure III-2, Appendix B, depicts the existing pipeline.) Pipes must also be designed to preserve the cold temperature of the water over the long distance from intake to terminus; insulation may be required. The cost of construction and/or deployment of a cold water pipe, however, is the overriding factor in determining the economic feasibility of the use of the cold water resource.

The design for future cold water pipes at Keahole will probably be similar to the existing 12-inch pipe. High density polyethylene (HDP), which has excellent thermal insulating characteristics, is the material used for that pipe. It allows

individual sections to be easily joined using a fusing machine, and the strength characteristics are sufficient to withstand deployment loads.

The 12-inch cold water pipeline was specifically designed to avoid bottom abrasion. Although the pipeline could be laid in a sandy bottom area between water depths of 200 to 500 feet, in water depths greater than 600 feet the offshore slope is very steep and large rock outcroppings and surface protrusions could occur along the cold water pipe path. Consequently, the pipeline design was based on a catenary concept where the pipeline transitions in the 500-foot water depth region from a bottom mounted pipeline to a floating, catenary design. Because HDP material is less dense than water, its natural buoyancy was used to lift the pipe off the bottom.

Security of the offshore pipelines is not anticipated to be of concern. In the nearshore zone (shallow water region) the pipelines will either be buried or armored to protect them from wave forces. There is little danger of potential damage to the exposed offshore portion of the pipelines from large vessel anchors because there are no designated anchorages or known mooring areas along the coastline of the project area; anchors from small fishing boats have little potential for damaging the pipelines.

2.0 Onshore Pipelines and Pump Stations

2.1 Description

The ocean water supply system for the U.S. DOE OTEC project will be located at NELH and will probably use the existing route off of Keahole Point. Both the cold water pipe and the warm water pipe will have the same terminus at the coast fronting NELH in order to minimize pump station construction costs.

A specific offshore route has not been determined for the initial HOST Park cold water pipe. If the existing NELH corridor is used, the pipe will have to run 7,000 feet overland from Keahole Point to the Park. The inland portion of the pipelines is expected to be exposed, but partially buried, in order to minimize construction costs.

Pipeline routing inland to the HOST Park would probably follow alongside the major access road. Security and safety concerns for the exposed pipe include possible vandalism and vehicle damage. A berm can be provided between the road way and pipeline. Since some excavation will be required to lay the pipes, the excess material could be used to build the berm. The 3-4 foot high berm would blend in with the surrounding environment and would provide a visual as well as physical barrier between the roadway and the pipelines. (Figure IV-5).

The pump stations for the HOST pipe will probably be constructed onshore; an onshore station will provide for more convenient maintenance of the pumps, which is necessary in order to maintain continuous flow capability. Depending on the existing ground elevation, the pump stations would be constructed almost entirely below grade. This would minimize storm wave damage to the structure. Any portion of the facility above grade would be designed to withstand estimated stormwave runup, overtopping, or impact loads. For this reason, the onshore pipelines from the pump station will either be buried or otherwise protected through the shoreline area for at least a few hundred feet inland. The pump

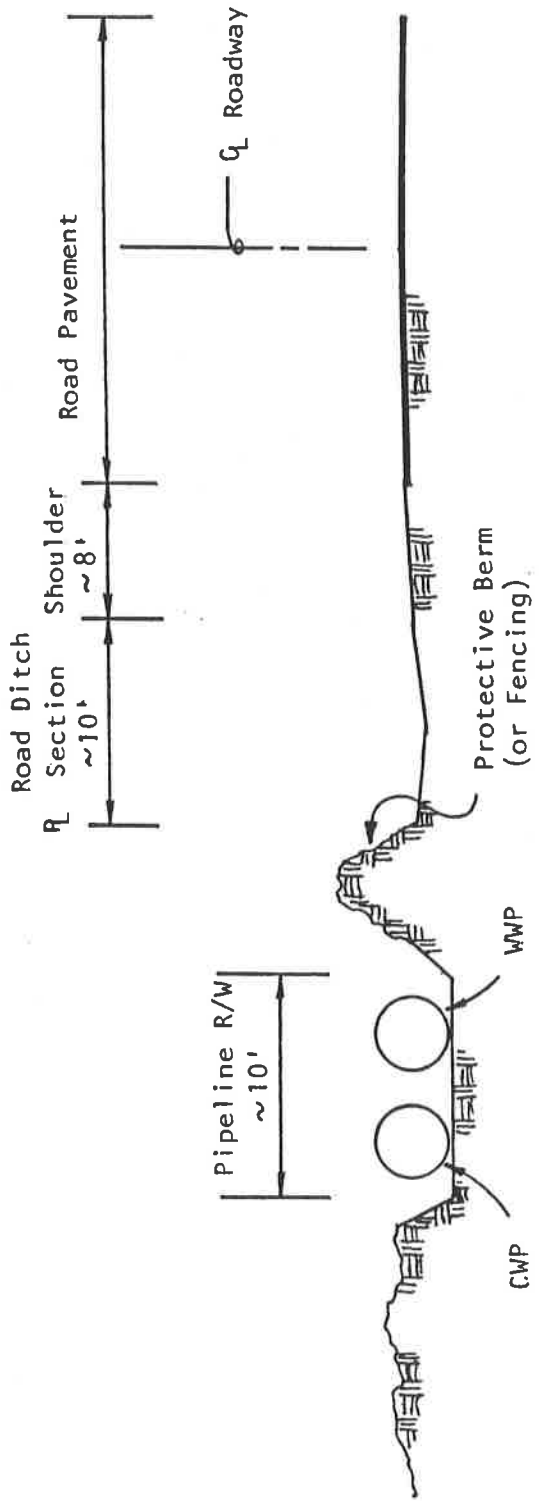

TYPICAL SECTION
 Not to Scale

Figure IV-5. Pipeline Location Along Roadway
 HAWAII OCEAN SCIENCE & TECHNOLOGY PARK
 NATURAL ENERGY LABORATORY OF HAWAII
 Keahole, North Kona, Hawaii

station(s) and pipelines near the shoreline will have minimal visual impact and should not hinder shoreline access. No specific security measures are deemed necessary for the shoreline portion of the pipelines or the pump stations.

2.2 Construction Activities

The conceptual design of the pump stations includes a deep, free surface sump. The suction pressure for the offshore pipe is developed by the elevation difference between sea level and the free surface of the sump. The estimated required elevation of the HOST cold water suction pipe at the pump station is approximately 25 feet below sea level; the distance from the shore to comparable water depth at Keahole Point is approximately 100 feet offshore. The estimated distance from shore to water depth of 25 feet fronting the HOST Park site is 400 feet.

Trenching will be required for very large diameter (\geq 48-inch) offshore pipelines through the shoreline and nearshore areas. The estimated offshore excavation quantity for a HOST 48-inch cold water pipe trench, if located at Keahole Point, is 90 cubic yards (cy). The comparable offshore excavation quantity for a location fronting the HOST Park site would be 890 cy.

The estimated required elevation of the warm and cold water pipes at the pump station for the DOE intake is approximately 17 feet below sea level. Since comparable water depth is found at the base of the shoreline cliff fronting NELH, little or no offshore trenching will be required.

3.0 Alternative Methods of Pipeline Construction and Deployment

3.1 Deploy at Sea

In this method, the one used to deploy the existing 12-inch coldwater pipe, the pipe is towed in sections from Kawaihae Harbor to Keahole Point. The first section of the pipeline is filled with air and capped at each end to provide buoyancy. Once the shoreward end is secured to the bottom, water is pumped into the nearshore terminus while air is vented from the offshore end. As the pipeline fills with water, the air-filled section of the pipe remains on the surface while the water-filled end settles to the bottom. The second section is towed to the site with both ends open. After the second section is connected to the first section at the surface, water is pumped through the pipeline, and the offshore end of the pipe is lowered to the bottom using three 3,000 lb anchors. (Refer to Figure 3-3, Appendix B, for an illustration of this process.)

3.2 Deploy From Shore

In this method the pipe sections are joined together at the intended site and subsequently pulled from shore into the water along the anticipated route. Individual lengths of pipe are arranged in parallel strings on shore, in line with the intended offshore route. The pipeline is then pulled out segment by segment using barges or tug boats. As the initial segment is pulled offshore, it is stopped and the next segment is rolled behind it and connected. The combined length is then pulled out and the joining process is repeated until the entire pipeline length is connected. (Figure 3-5 in Appendix B illustrates this deployment operation.) The pipeline is usually dragged on the bottom since waves and currents can easily push the pipeline off course if it is buoyant. This requires that the bottom be cleared of any

off course if it is buoyant. This requires that the bottom be cleared of any obstruction to dragging; pipeline material must be resistant to abrasion or protected in some manner.

4.0 Environmental Impact Analysis

4.1 Existing Conditions

The strand or beach zone vegetation forms a narrow to somewhat wide (up to 300 feet in width) belt along the coast. Clusters of naupaka shrubs are frequently encountered. Other species found along the shore include hi'aloa, kiawe, beach morning glory, Bermuda grass, manienie, and tree heliotrope.

Archaeological sites are present along the shore. These are described in detail in Section G. The beach areas are used by the general public for recreation activities such as fishing, diving, nori collecting and camping. Recreation impacts are also discussed in detail in Section G.

The rocky basalt shoreline at Keahole Point drops abruptly to water depths of about 15-20 feet, then the ocean bottom slopes gradually to a shelf break at about 40 to 50 foot depths. The shoreline and nearshore foundation material is primarily basalt. Sand tossed ashore by storm waves forms a veneer cover along the shoreline. The nearshore bottom is virtually bare of sand or coral growths at less than 25-foot depths within the areas to be trenched for the offshore pipes. The rocky basalt shoreline fronting the HOST Park slopes more gently offshore than at Keahole Point. The shoreline and nearshore foundation is primarily basalt, however, there is considerably more sand along the shoreline areas than at Keahole Point.

The surface waters around Hawaii are low in dissolved plant nutrients and support a low standing crop of phytoplankton. Calanoid copepods are the most abundant zooplankton. Macrozooplankton in Hawaiian waters are generally characterized as having high diversity, but low abundance.

Myctophidae, midwater lantern fish, were the most abundant fish larvae found in 1980 samples (Noda, et al., 1980). They are of no direct economic importance, but may be, because of their large numbers, important components of midwater food chains.

The Keahole Point region harbors one of the most diverse and abundant reef fish assemblages in the populated Hawaiian Islands. Surveys for a range of depths, locations, and seasons have recorded at least 120 reef fish species (ORCA, 1977, 1978). There is a distinctive zonation of species composition according to depth. Generally, the abundance of adult fish decreases with depth offshore of the Keahole Point region.

The surge zone (nearshore to -20 feet) supports the largest fish biomass which is probably associated with the presence of lush growths of seaweed. South of Keahole Point, dense beds of the finger coral, Porites compressa, at depths from 50 to 100 feet serve as an important nursery area for juvenile reef fish.

Fish species which are conspicuous in diving surveys include some important market species (the omilu, Caranx melampygus; the 'oio, Albula vulpes; the weke

'ula, Mulloidichthys vancolensis); some important subsistence species (the kole, Ctenochaetus strigosus; the nenu, Kyphosus sp.); and species of damselfishes, butterflyfishes, and juvenile forms of surgeonfishes which are collected for the commercial aquarium fish trade.

The fish fauna are quite diverse and abundant along the steep boulder-strewn slope extending from -150 to -250 feet, and include surgeonfishes, especially the kole, the ta'ape Lutjanus kasmira, butterflyfishes (the longnose Forcipiger sp.) the lemon butterflyfish Chaetodon miliaris, the false moorish idol Heniochus diphreutes), various parrotfishes, and kumu (Parupeneus porphyreus) or a kumu-like species of goatfish.

From -250 to -300 feet, the angle of bottom slope decreases and the bottom is littered with lava rock rubble. Ta'ape have been observed in this zone, and surgeonfishes are also common. Rock crevices harbor squirrelfishes and occasional moray eels.

At a depth of -300 feet, there is an abrupt transition from a rocky slope to a sandy terrace, where vast populations of ta'ape have been observed. The next major change in the bottom occurs at about -500 feet, where the sandy plain rolls off to a steep rocky slope which supports moderate fish populations, mostly squirrelfishes and anthiines, with an occasional snapper, Symphysanodon typus. Anthiines inhabit occasional rocky ledges at depths below -500 feet (Harrison, 1985).

The most productive commercial fishing areas in the populated Hawaiian Islands are inshore (shoreline to 2 miles offshore) and offshore (2 miles to 20 miles offshore) waters fronting the Kona coast. Yellowfin tuna (ahi), blue marlin, opelu, and ono account for the greatest catch weight. Kona is also the site of the largest charterboat fishery in the state and is the focal point of big-game fishing tournaments (HDLNR, 1980). The Keahole area is one of the traditional Kona fishing grounds for yellowfin tuna (ahi) and skipjack tuna (aku). Commercial fishing and charterboats commonly frequent the offshore waters. A limited amount of bottomfishing also occurs offshore.

The Keahole region is one of the most important areas in the state for aquarium fish collecting (Nolan, 1978). In FY 1983-84, the areas from Keahole Point north produced about 16% of the statewide catch of aquarium fish; areas from Keahole Point south produced about 3% of the statewide aquarium fish catch in FY 1983-84, compared to 6% in FY 1981-82 (State Div. Aquatic Resource, statistical catch summaries).

A number of species of dolphins occur in Hawaiian waters. The bottlenose dolphin (Tursiops gilli) occupies a wide variety of habitats around the islands including estuaries, inshore and offshore waters. Individuals grow to a size of four meters and more. The Spotted dolphin (Stenella attenuata) is very common in Hawaii, and may be the most abundant Hawaiian cetacean. It is found in large herds throughout the islands, nearly always at least three kilometers from shore. The spinner dolphin (Stenella longirostris) is also found throughout the Hawaiian chain. The Hawaiian population has behavioral and morphological differences from populations in the eastern tropical Pacific. Schools tend to remain in well-defined home ranges. These dolphins eat primarily mesopelagic fish and epipelagic or mesopelagic squid. The Rough-toothed dolphin (Steno bredanensis) is common in

Hawaiian waters, but is rarely seen because it favors waters more than 900 meters deep. (Shallenberger, 1979).

Species of concern in the Keahole region include the endangered humpback whale (Megaptera novaeangliae) and the threatened green turtle (Chelonia mydas).

The Hawaiian population of humpbacks is the largest of the three Pacific populations, numbering approximately 1200. The whales usually first appear in Hawaiian waters in November, peak in abundance in mid-February, and are scarce by mid-May. Areas of primary importance are Penguin Bank and the waters between Maui, Molokai, Lanai and Kahoolawe (Shallenberger, 1979). Calves are most abundant in Maalaea Bay and off Kaena Point, Lanai. Areas of secondary importance he identifies as Kaula, Niihau, the south Kauai coast and the northwest coast of Hawaii. The humpback whale management plan (USDC, 1983) adds the north and east coasts of Oahu and the bank extending off Ka Lae (South Point), Hawaii.

The threatened green turtle is the only turtle species which lives and breeds in Hawaii. The hawksbill and leatherback turtles also occur in Hawaiian waters and are designated endangered. The Pacific ridley turtle is also occasionally sighted in these waters (Balazs, 1980). More than ninety percent of all breeding by Hawaiian green turtles occurs at French Frigate Shoals, and most other nesting sites are also in the Northwestern Hawaiian Islands. The annual production of hatchlings for the Hawaiian archipelago has been estimated to be 26,500. Nesting occurs most commonly in June and hatching takes place in August. Green turtles have been found to feed on 35 species of benthic algae, one marine angiosperm and nine types of invertebrates.

The nearest important resident area of green turtles to the Keahole region is at the northwestern tip of Hawaii. Another important area is found along the southeast coast at Ka'u.

The dominant coral species along the Kona coast are Porites compressa and P. lobata. These two species represent almost 96 percent of the coral cover, and over 80 percent of total bottom cover in some areas that have been surveyed.

The wave-washed bench in the surge zone is subject to severe wave activity, particularly fronting Keahole Point. Coral diversity is low in the high surge zone; Pocillopora meandrina is the most abundant species, but coral coverage is less than five percent. Individual colonies are small in size, rarely larger than six inches across. Encrusting coralline algae are common in this zone, but generally benthic flora and fauna are sparse (Nolan and Cheney, 1981).

The nearshore terrace along this coastal segment varies from about 200 to about 400 feet wide at depths of -15 to -60 feet. Coral diversity and cover are high in this zone, with cover to forty percent. Porites lobata is the dominant coral. Individual colonies reach three feet in width. Encrusting algae and sea urchins (especially Echinothrix diadema and Tripneustes gratilla) are very common.

The substratum of the nearshore slope consists of unconsolidated limestone rubble, basalt boulders, coarse sand and rock outcrops. Coral cover is dense, reaching almost 26 percent. The dominant species is P. compressa.

There are three distinct zones in the pipeline corridor deep offshore of Keahole Point. These zones are characterized by predominantly different substrata types, slopes, ambient light and to some extent nutrient regimes, and display consequent biological differences.

The nearshore slope extends offshore in water depths from about 45 to 80 meters. The slope is fairly steep, averaging about 40 degrees. Most of the hard surfaces are barren and show a light cover of sediment. Fleshy seaweed algal beds are conspicuously absent despite the abundant sunlight. Halimeda sp., encrusting coralline algae, encrusting sponges, and tunicate colonies are common on vertical or near-vertical faces, as well as small colonies of the corals Porites sp., Pocillopora sp. and Leptastrea sp.. The most abundant macrofaunal invertebrate is the antipatharian, Cirripathes anguinea. The sea cucumber, Holothuria atra, and the urchin, Chondrocidarus gigantea, are most abundant echinoderms. (Harrison, 1985)

The upper sand plain is the region of depths between about 80 and 110 meters. From 80 to 90 meters depth the substratum consists of evenly distributed fist-sized lava rocks, but at 90 meters there is an abrupt transition to a sandy bottom. The sediment surfaces in this zone show gastropod trails, burrow openings, mounds and pits. The deeper areas have darker surfaces, presumably films of epibenthic algae or diatoms. Halimeda is present. Macro-invertebrates include the echinoderms C. gigantea, H. atra and the burrowing anemone Cerianthis. Burrowing fish and eels are also present. Hard surfaces such as the cold water pipe are abundantly colonized by coralline algae, Halimeda, sponges, tunicates, barnacles and other sessile invertebrates. An extensive algal mat is present on rocks. Taape (Lutjanus kasmira) are present between 75 and 90 meters. Also present are numerous large acanthurids (Naso sp.), holocentrids, muraenids, C. miliaris and H. diphreutes. (Harrison, 1985)

The lower sand plain extends between the depths of 110 and 150 meters. The substratum is a gentle sandy slope. At about 120 meters, the sediments become larger, greater than 4 mm, and organic content is higher. These coarse-grained sediments are dark with encrustation, and bioturbational features are more common. Fine white sediments are apparent under the armored surface. Halimeda is present below 125 meters along with C. gigantea and numerous dead pen shells (Pinna sp.). (Harrison, 1985)

Below 160 meters the slope again increases to about 40 degrees. The hard substratum shows less encrustation than at shallower depths and algal turfs are absent. Sponges, tunicates, hydroids, gorgonians and a small ahermatypic coral are present. The most commonly seen organisms are red and white banded shrimp. (Harrison, 1985)

4.2 Construction and Deployment Activities and Impacts

4.2.1 Construction Activities

Key aspects of any construction scenario would include the possibility of drilling, blasting, and trenching; pipe installation, backfilling and armoring or anchoring. The potential impacts of these actions are discussed in the sections below.

- o If trenching is required (because of size and location of the pipe), drilling and blasting may be necessary for excavation due to the hardness of the basalt material. The porosity of the rock formations in the area lowers the efficiency of explosives so that large quantities of high-speed explosives will be required for rock breaking. Nevertheless, unlike coral limestone, the dense basalts would generate relatively little silt during operations. Bienfang (1975) reports no significant adverse impacts to the marine environment from dredging of Honokohau Harbor. From his results, it was calculated that about 2.3 percent of the dredged material volume remained as suspended sediments in the fine sand to silt size range, and that if the same ratio held, only about 2 cy of silts would be generated by dredging for the HOST Park cold water pipe if it were located off Keahole Point. This would quickly be dispersed over large distances due to the strong currents. If the pipe were installed offshore of HOST Park, the total silt volume generated would be 30 cy, due to the larger dredging volumes. In the latter event, maximum sediment thickness, in the absence of any currents, would average 1 mm over a 500 x 500 feet area. Nearshore waves and currents, however, would be expected to flush the silts from the area rather quickly.

Impacts of construction would be transient for the most part. Use of any type of bottom-fixed platform or trestle would disrupt bottom communities in the immediate impact area, as will blasting. Corals in particular are susceptible to this type of physical damage. Coral destruction reduces the amount of habitat available to other species.

Drilling and blasting would both produce noise, and blasting would produce shock waves in the water. The impact of drilling noise would be transient; some localized behavioral modifications can be expected among motile organisms. Shock waves generated by the blasting would cause mortalities in sufficiently near fish, turtles, or mammals. Of most concern are the potential effects on the endangered humpback whale and the threatened green turtle.

Other impacts of drilling and blasting would include a temporary reduction in water quality and undoubtedly a temporary loss of recreational access.

The most significant impacts associated with short-term construction activities would be through alteration of marine habitats as a result of the construction of pipelines, particularly in the nearshore zone. The amount of excavation and trenching required for the pump station and offshore pipes depends on the shoreline elevations and the offshore bathymetry in relation to the sump design requirements. While an offshore submerged pump station would require little or no excavation, the engineering and maintenance problems associated with such a design presently indicates that an onshore pump station is more feasible.

Various strategies to minimize the potential adverse impacts of blasting operations can be employed. Specific mitigation measures include prohibition of blasting while whales are present in Hawaiian waters, visual surveys of the area prior to blasting, limitations on charge size and use of shaped charges to minimize shock waves. Coordination with the National Marine Fisheries Service will be necessary to develop specific measures for this project.

- o The trench length offshore of NELH is projected to be about 100 feet whereas a trench offshore of HOST Park would be about 400 feet long. For a 48-inch HOST Park cold water pipe off Keahole Point, the estimated offshore excavation volume is 90 cy. Estimated offshore excavation quantities are 890 cy and 400 cy for the HOST Park cold water pipe and warm water pipe, respectively.

Blasted rock could be mucked out by clamshell or dragline and is commonly cast to a convenient underwater stockpile for later use (Parsons Hawaii, 1984).

Underwater earthwork will have a temporary negative impact on water quality, but circulation and flushing in this area are sufficient to minimize this impact.

Benthic organisms in the line of the trench will be displaced or destroyed. For a single pipeline, the area affected would not be large. More extensive damage could occur in the future depending upon how and where the projected maximum 10 to 16 pipelines are deployed. If an underwater stockpile is used, benthic biota in this area would also be smothered or crushed.

Dense colonies of the finger coral at depths below -50 feet serve as an important nursery ground for juvenile fishes. Damage to these coral beds during the placement of offshore pipelines could be detrimental to fish populations.

- o New surfaces of pipelines and those created by dredging or blasting have the potential to stimulate the development of ciguatera food chains. Ciguatera is a form of fish poisoning caused by human consumption of fish whose tissues contain a paralytic neurotoxin. Several species of microscopic, unicellular algae which grow primarily attached to larger seaweeds have been implicated as the source of ciguatoxin in the Pacific. Blooms of the one-celled algae apparently initiate the transfer of toxic material through the marine food chain until it becomes concentrated in the tissues of certain species of food fish. The environmental conditions which trigger massive blooms of the algae are not known, although conditions which have been repeatedly associated with ciguatera are dredging of reef areas, sunken ships, and rainfall-runoff patterns.

Incidences of ciguatera poisoning in Hawaii have sometimes been connected with construction activities which have exposed new submerged surfaces through dredging. A small bloom of one species of toxic algae occurred at Pokai Bay in August 1978, coincident with the dredging of a small boat harbor nearby and with an outbreak of ciguatera in fish from that area.

To date, no one can predict whether or not a given construction activity in the marine environment will lead to incidences of ciguatera poisoning. Extensive dredging of Honokohau Harbor and Kawaihae Harbor on the island of Hawaii occurred without known incident.

Blooms of certain species of phytoplankton which cause red tide can also make fish inedible. Red tides are observed annually immediately north of

Keahole at Mahaiula (Clark, in press). There is a large volume of fresh water intrusion in the inner bay at Mahaiula. Based on the theory that most red tide outbreaks are associated with terrestrial runoff, they would not be expected as a consequence of salt-water operations.

The only mitigating measure possible for ciguatera is to monitor newly exposed submarine surfaces and newly-deployed pipeline surfaces for blooms of the suspected algae (Gambierdiscus toxicus). It is possible that minimizing disturbances of the bottom during construction will reduce the likelihood of ciguatera, but current information is not adequate to predict or prevent such an occurrence (Myers, et al., 1985).

4.2.2 Impacts of Presence and Operation of 10 to 16 pipes.

The physical presence of pipelines offshore of NELH-HOST Park could modify the benthic environment.

In the trenched areas, few long-term negative impacts could be anticipated. Infaunal communities may lose a small amount of habitat, but this will not be significant. Epibenthic communities can be expected to recolonize the disturbed surface in a relatively short time.

Seaward of the trenched areas, the pipelines could be anchored to the seafloor, and possibly, armored. The attraction of bottom-dwelling fishes to man-made structures placed on the ocean floor is well documented. Bottom areas of substantial vertical-dimension heterogeneity are known to harbor a more diverse and larger biomass of fishes (and invertebrates) than relatively featureless bottoms. Generally in shallow waters, corals are a major structural element of this vertical relief. The habitat complexity created by an offshore pipeline as it runs shoreward across the featureless sandy terrace at depths from -300 to -500 feet offshore of Keahole could enhance its fish attracting qualities. The species composition and abundance of the fish assemblage which might be attracted to pipelines constructed offshore of Keahole are a matter of conjecture. In all probability, it would include a mix of reef species (surgeonfishes, squirrelfishes), some pelagic wandering species (jacks, opelu), and some of the deepsea bottomfish species. The latter group could include commercially-desirable species such as uku (Aprion virescens) and opakapaka (Pristipomoides filamentosus) or it could be dominated by the nuisance ta'ape species (Lutjanus kasmira). Pipelines are unlikely to contribute much to attracting fish in shallower regions where the rocky bottom already has considerable natural relief or where dense coral beds afford considerable habitat for reef fishes. Further, HDPE pipe is expected to be used. this high density material, because of its smoothness, resists growth of encrusting species.

The operation of intake pipes could result in impingement and entrainment of organisms. Impingement refers to larger organisms caught on protective screens positioned at some point in front of the pumping system. Entrainment affects smaller organisms like plankton, which may pass entirely through the pumping system.

Little impingement or entrainment is expected from cold water intakes placed at a depth of 2,000 feet since the eggs and larvae of most commercially-important fish are buoyant and tend to reside near or at the surface; few larvae are found below

200 meters depth. Secondary entrainment of organisms is possible in seawater returns, especially from pipes which would create a coherent plume.

Impingement and entrainment effects of the warm water pipes on the plankton community are not expected to be significant because of the large numbers of these ubiquitous organisms and their short generation times. The most vulnerable component of the shallow water fauna is the larval fish. Commercial and recreational fisheries depend on steady recruitment of small fish to provide harvestable stocks of larger fish. Mortalities of larval fish due to impingement on pipe intake screens or entrainment in intake water could theoretically reach proportions which may cause population damage. However, impingement or entrainment would only be a factor on warm water intakes placed where larval fish are concentrated.

There is presently no conclusive evidence of actual declines in any fishery due to impingement or entrainment losses (Myers, et al., 1985). However, reef fish or bottomfish stocks which are being heavily fished may not be able to compensate for the individuals lost through entrainment or impingement and yield could be affected. Knowledge of the survival of these early life stages of the major commercial species is too incomplete to predict the impact on yield (Myers, et al., 1985).

Recruitment of juvenile fishes to reefs in Kona, Hawaii was monitored by Walsh (1984), who found that many species exhibited strikingly low levels of recruitment over a 51-month period. Loss of larval fish to offshore or other unfavorable currents may be responsible for low levels of juvenile recruitment in this and other Hawaii studies. The patterns of recruitment observed appeared to be most closely tied to changes in water temperature and/or photoperiod (Walsh, 1984).

The ability of larger fish to avoid the intake flow fields can be maximized by keeping the flow speeds as low as practicable. In this respect, the larger the diameter of the pipe, the better. Intakes should be located away from areas of biological importance. Impacts on the fishery due to impingement and entrainment are expected to be negligible compared to other pressures on local fisheries.

The ocean water supply pipes which will cross the strand vegetation are of some concern. Wherever possible, the pipes should be sited so that they do not cross over vegetated areas. If vegetation must be disturbed then the area should be replanted immediately to stabilize the sand.

4.3 Summary and Recommendations

At least 10 and as many as 16 ocean water intake pipelines could be installed offshore of the NELH-HOST site; each additional offshore pipe will have many of the impacts discussed in the previous sections. Smaller pipes have fewer impacts than larger ones because trenching may not be required. In the case of larger pipes, impacts can be mitigated in the design of the project through awareness and avoidance of offshore areas of special biological or recreational importance.

E. SEAWATER RETURN FLOW DISPOSAL ALTERNATIVES

Disposing of the large volumes of seawater that might be generated by OTEC and mariculture operations at NELH and the proposed HOST Park in an environmentally acceptable manner is a major concern. Protecting the integrity of the resource waters is a prime consideration for both NELH and HOST Park. It is the quality of these waters that makes the planned activities at the new facilities possible. An outfall for OTEC water and two methods of on-land disposal for mariculture seawater return flows have been evaluated. Each of these methods is described and assessed in the following sections.

1.0 Existing Disposal Methods

1.1 Direct Disposal Via Canal:

Ocean water from OTEC experiments at NELH is disposed of into a canal approximately 60 meters long and 15 meters wide. The canal surface is rough, recent lava with a maximum depth of less than 20 cm. The total maximum discharge is approximately 1,000 gpm., of which about 60 percent is surface water. The discharge is monitored weekly. The results of the water quality monitoring program are presented in Appendix F. The discharge is permitted under National Pollutant Discharge Elimination System (NPDES) Permit No. HJ 0020893 (effluent discharge permit). The permit period is from 4/1/81 to 3/31/86.

Data collected from the NELH warm water intake indicate that the water quality standards are being met.

1.2 Injection Wells:

Approximately 800 gpm (1.2 mgd) of ocean water used by Hawaiian Abalone Farms is disposed of into two injection wells which are located just behind the shoreline fronting the NELH facility. The wells are 12-inch diameter, uncased holes augered to a depth of 20 feet from the existing ground surface (elevation +10 feet). Three wells were drilled but one did not accept the required quantity of ocean discharge.

1.3 Surface Spreading:

Approximately 200 gpm (0.3 mgd) of ocean water used in mariculture operations is disposed of through surface spreading through a cinder layer placed over graded lava.

2.0 Proposed Ocean Outfall

2.1 Description:

A mixed-water discharge pipe is proposed as the means to dispose of the projected 16,000 gpm of seawater that will be used in forthcoming OTEC experiments. Based on available information to date (pre-design) it is anticipated that this pipe will be 48-inches in diameter and 1600 feet long; it will discharge at a depth of 200 feet offshore. It is assumed that the discharge water will be low in temperature and may contain high concentrations of nutrients and some trace metals and low oxygen concentrations.

The anticipated plume resulting from the proposed OTEC discharge was modeled by Noda (Appendix B). The results of their analysis indicate that the mixed-water discharge plume, being colder and denser than ambient waters at the 200-foot depth of discharge, would remain submerged. The initial momentum-dominated plume would flow along the bottom until reaching equilibrium density with the surrounding water, whereupon the plume will spread laterally and be advected away from the area by the nearshore currents.

2.2 Environmental Impacts and Mitigating Measures

Based on the physical oceanographic and chemical mass balance considerations, discharges into the area affected by the plume are unlikely to negatively impact the benthic community. Currents offshore will rapidly disperse effluents and excess particulate organic material. Additions of dissolved nutrients will stimulate uptake by phytoplankton, but any growth response will require a lag on the order of a day or two, during which time the population will be advected away from the discharge. The trophic subsidies resulting from deposition of particulates near any outfall would not be expected to noticeably alter the existing community structure because the factors apparently limiting the benthic communities in the area are physical stresses imposed by scour and sandfall.

E → Because the discharge plume is expected to remain on the shelf region at depths greater than 200 feet and shallower than 400 feet, it will have little potential for impacting either the warm water intake sources or the cold water intake sources at Keahole Point and HOST Park.

? → The elevated nutrient concentrations in the discharge will occur above the nutricline and at least partially within the mixed layer resulting in subsidies to primary producers, mainly phytoplankton. This discharge will also be characterized by elevated levels of trace elements, low dissolved oxygen concentrations, and trace levels of chlorine. The multi-year federally-funded field data collection and analysis program (Univ. of Cal., Berkeley; In prep.) has concluded that the presently planned OTEC discharge will not have any significant impact.

The OTEC return flow will contain chlorine at certain times. Chlorine breaks down very rapidly in seawater, but it produces more toxic halogenated by-products which may bioaccumulate. Research at NELH has shown that very small quantities of chlorine, generated electrically inside the pipes is extremely effective in controlling biofouling. The current NPDES permit restricts the amount of chlorine that can be discharged. It is anticipated that future permits will contain the same restrictions.

Another concern is potential additions of metals from deep waters or from heat exchangers. Elevated metals concentrations are not expected to have adverse impacts on waters and biological resources in and below the thermocline.

Impact of the proposed outfall on the marine environment are described in detail in Appendix F.

3.0 On-Land Disposal of Seawater Return Flows

3.1 Assumptions:

Two alternative on-land disposal methods for mariculture-generated seawater return flows at the proposed HOST Park and NELH have been proposed: (1) shallow surface trenches; and (2) deep gravity-injection wells. The basic engineering concept underlying both methods is the conversion of used ocean water into groundwater flow; taking into consideration the storage capacity, porosity, and the filtration effect of the lava formation to provide dispersion, diffusion and long residence time before the water is discharged to the ocean as underwater seepage flow along the coast. Both methods would use gravity as the prime moving force and thus conserve energy. The following outflow assumptions were used in evaluating the two methods and assessing their environmental impacts:

HOST PARK:

Initial development--20 mgd (13,900 gpm)

Full development: 144 mgd (100,000 gpm)

NELH:

Full Development--39 mgd (27,000 gpm)

Two alternative locations for ocean water disposal have been proposed for the HOST Park site. Alternative one proposes an area located approximately 2,000 feet from the shoreline at a ground surface elevation of 40 feet above sea level. Alternative two proposes an area approximately 1,000 feet from the shoreline at a ground surface elevation level of approximately 30 feet. The exact location will be determined in the detailed planning and design phase of the HOST Park development.

The potential location for the NELH ocean water disposal area has not been determined as yet. An area at the south end of the site, roughly parallel to and approximately 1,000 feet from the shoreline at an elevation of 10 feet above sea level, is being considered.

The two on-land disposal methods are described in detail by Dames & Moore in Appendix C. The characteristics of each are summarized briefly in the following sections.

3.2 Shallow Surface Trench Disposal:

In this method, seawater return flows (pre-treated if necessary to meet water quality standards) are piped or conveyed via a lined ditch to a shallow trench located in the ocean water disposal area. Because of the porosity of the lava, and the volume and intensity of the flows, the disposed water percolates rapidly into the ground. For example, it is estimated that at a constant disposal rate of 20 mgd envisioned for the initial HOST Park development, the trench would be less than half full. In the future, if problems with clogging occur, filtration beds and lined settling ponds can be constructed in the disposal area to filter out solids and

remove entrained air before the seawater is disposed of in the trench.

For the initial stages of HOST Park, it is proposed that a 100-foot long trench, approximately 10-foot wide by 10-foot deep, be constructed. The performance of the disposal trench should be monitored to collect operation and maintenance data. If the method proves to be effective, and its performance validates the theoretical computations used in its design, the trench can be extended incrementally as HOST Park grows in size. It is estimated that the maximum HOST Park disposal quantities of 144 mgd could be handled by extending the length of the trench to 245 feet. (The available length of the planned disposal area is more than 900 feet.)

At NELH, disposal of 39 mgd of used seawater would require a 175-foot long trench approximately 10-feet wide and 10-feet deep. The phasing of mariculture facilities at NELH is currently unknown, therefore, the sizing of the disposal trench will require additional study during design. If it is determined that the shallow trench method of seawater disposal might be implemented, an area approximately 350 feet long and at least 20 feet wide will be reserved for that purpose.

For safety reasons the disposal trench areas would be fenced. It is possible that they would also be covered to preclude the congregation of birds and to retard algae growth. Foot bridges would be installed to provide personnel access for monitoring and maintenance.

It should be noted that although trenches do not fall under underground injection control (UIC) regulations, the State Department of Health should be consulted before this method of seawater return disposal is implemented to ensure that there is no conflict with the general prohibitions of Chapter 342 HRS on discharges into state waters.

3.3 Large-Diameter Deep Gravity-Injection Well Disposal:

In this method, pre-treated seawater return flows are piped or conveyed via a lined ditch to the ocean water disposal area and disposed of into injection wells. The wells would be approximately 2-feet in diameter and 100-feet deep with slotted casings to prevent collapse and to facilitate maintenance. The wells would be drilled parallel to the shoreline area in 2 or 3 rows and spaced at least 100-feet apart. They would be located in one of the two previously described alternative ocean water disposal areas on the HOST Park site.

It is estimated that 3 wells would be required to dispose of the 20 mgd seawater return flows projected for the initial phase of the HOST Park development. At maximum development (144 mgd), 15 wells would be required. It is assumed that each well could handle approximately 14.4 mgd (10,000 gpm); therefore, in the initial HOST operation (20 mgd), only 2 of the 3 wells would be operating. At maximum development (144 mgd), only 10 wells would be operating at one time. The extra wells would be used for standby capacity for planned maintenance or in the event one or more wells became inoperative due to clogging.

Implementing the deep injection well concept at NELH would be more problematic. Due to the low surface elevation of the site, the injection rate for each well would have to be reduced to 11.5 mgd (8,000 gpm) to reduce well head build-up to below the ground surface. Five wells, four in operation and one on standby, would be

required to dispose of the 27,000 gpm of seawater return flows projected for full development of the NELH site.

Although the proposed seawater return flows would be injected into an exempt aquifer, ocean water disposal by means of deep gravity-injection wells would require a U.I.C. permit from the State Department of Health.

3.4 Environmental Impact Analysis:

3.4.1 Characteristics of the Aquifer and the Plume

The aquifer in the Keahole area is highly permeable. Because the basalts are highly fractured, vertical barriers to groundwater movement are small, and in some localized areas water may be transmitted vertically more readily than horizontally.

An unconfined Ghyben-Herzberg lens containing brackish water underlies the area to at least 5 miles north of Keahole, at least 3 miles to the east, and more than 5 miles to the south (Water Resources Research Center, 1980). The lens is probably less than 125 feet thick and discharges freely along the coast in a narrow band a few feet wide in the intertidal zone. The basal lens water does not meet the U.S. Drinking Water Standards even at the top of the lens and at a distance about 3 miles from the shoreline. Chloride has been measured to be about 5,000 milligrams per liter (mg/l) to 520 mg/l, and total dissolved solids (TDS) to be about 1,000 to 1,200 mg/l over this distance.

The brackish water of the lens flows toward the coast along a regional gradient of about 1 foot per mile. The head in well 4360-1 (Kalaoa), 3 miles inland of Wawaloli Beach, was 3.2 feet when drilled, implying an average gradient of 1.1 feet per mile. Kanehiro and Peterson (1977) gave an average gradient of 1 to 2 feet per mile south of Keahole for the reach between Kiholo and Puako. The brackish water discharges preferentially at indentations in the coast, although only one shoreline spring near Wawaloli Beach, noticeable during low tide, has been observed. Groundwater flow lines converge toward these indentations while diverging at headlands.

The salt water below the lens in the near-shore area is alternatively driven inland and seaward by tidal action; in some places, the lens is visible where the basaltic surface has collapsed and near the shore where marine sediments have filled depressions in the original surface.

The sea water return would travel as a plume surrounded by a zone of diffusion. Over the width of the plume, the injected ocean water would constitute the discharge front at the coast. The bulk of the groundwater to be displaced is ambient saltwater with a density similar to that of the disposed ocean water. The major differences between the ambient groundwater and the disposed ocean water are assumed to be salinity and temperature.

A computer model was used to estimate the limits of the plume. The assumptions used in the model, and an analysis of the results of the calculations, are set forth in Appendix C. **The resulting values are believed to be very conservative because the ambient groundwater and the heterogeneities of the lava formation would interfere with flow paths long before they could be realized.**

E
The calculated **maximum** limits of the underground plume resulting from the disposal of 20 mgd of seawater (the projected volume for the initial increment of HOST Park) 2,000 feet from the shoreline is 2.7 miles at the shoreline and 0.9 miles inland. It would require between **187** days and **3.6** years for this water to re-emerge at the shoreline and between **32** to **216** years to reach a distance of 1.5 miles down the coast, depending upon which model is assumed.

The maximum limits of the plume resulting from disposal of discharges anticipated for full development of HOST Park (144 mgd) would be 22.4 miles at the shoreline and 2.4 miles inland. The residence time would be 26 to 144 days. To reach a distance of 1.5 miles would require pumping for 4.4 to 30 years at 144 mgd.

Because the NELH facility is closer to shore, the disposed ocean water would have a shorter residence time. Assuming disposal of 39 mgd about 1,000 feet from shore, residence time would be between 12 and 80 days.

E
It has been calculated that significant discharges are limited to approximately 8,000 feet up and down the coastline from the point approximately midway between the HOST and NELH sites, for the combined injection of the two facilities. For injection at HOST Park only, the significant discharge occurs up to 6,400 feet away, and injection at NELH only results in significant discharge up to 4,000 feet away. The discharge per unit area at the coastline varies with the distance along the coastline, the thickness of the plume at the coastline, and with the slope of the ocean bottom. The maximum rate of discharge would occur immediately downstream of the disposal area. Average discharge from HOST Park is estimated to be 2.2 gallons/square foot/day. At the NELH facility, the discharge would average 4.5 gallons/square foot/day.

3.4.2 Anchialine Ponds

Exposures of the lens (anchialine ponds) were described by Maciolek and Brock in their 1974 survey of anchialine ponds along the Kona coast. They identified three ponds in the NELH area. One is small (less than 10 m²) and two are intermediate in size (10-100 m²). They are all shallow, with salinities of about 7-8 ppt. Bottoms are a mixture of rock and sediment. Two have no bordering vegetation; one has trees, shrubs and emergent vines and succulents. Biota in these ponds includes benthic algae, worms, mollusks and crustaceans. Among the latter are Halocaridina rubra, a small endemic red shrimp. One of the ponds has a population of Macrobrachium grandimanus, an endemic prawn more common to Hawaiian streams. No fish were observed in these ponds. According to the ranking of Maciolek and Brock, they are not of high natural value.

Six anchialine ponds occur in the proposed HOST Park area. All are small (less than 10 m²) and shallow, with salinities in the range 4-6 ppt. Bottoms show little if any sedimentation. Trees and grasses border the ponds. The biota of the HOST ponds is significantly different from that of the NELH ponds in that the former include no benthic algae. The fauna consists of two species of snails and the two endemic red shrimp, H. rubra and Metabetaeus lohena. None of the ponds is classified as having high natural value.

The nearest ponds of exceptional value (Maciolek and Brock, 1974) are the 29 Kahanaiki Ponds located near Wawahiwaa Point, 2.25 miles south of Keahole Point and about one mile southwest of the southern limit of the park. These are shallow to medium-deep ponds, most of small size, but some larger than 100 m² in surface area. Salinities in these ponds range from 9-13 ppt. Bottom types vary from rock to sediment covered, and surrounding vegetation includes trees, grasses and vines.

3.4.3 Potential Impacts and Mitigating Measures

The projected volumes of injection are so great that there is little or no difference in the environmental effects between the two alternative on-land disposal methods. The impact analysis which follows, therefore, does not distinguish between the two.

The on-land disposal of ocean water would disrupt and displace the existing Ghyben-Herzberg lens for some distance inland and for a determinable width from the disposal area to the coast. The lens is unsuitable for groundwater development, but apparently is the source of water for some stands of kiawe trees located north of Keahole Point, and in the vicinity of Wawaloli beach. In the long term, these trees would probably not survive the displacement of the brackish water lens by the saline ocean water plume. The effects on the brackish water lens cannot be mitigated except by foregoing on-land ocean water disposal.

The anchialine ponds on the project site will slowly lose their brackish character. If mitigation of this impact is desirable, it should be easy to artificially create new anchialine ponds by digging pits to intersect the water table at nearshore locations out of the zone of impact of the seawater return flow. Care should be taken not to create large quantities of silt in this process as this would tend to accelerate aging of the ponds.

The brackish water lens is also the source of water for some anchialine ponds in the vicinity of Wawahiwaa Point, approximately 1.5 miles south of the proposed ocean water disposal area of HOST Park (1 mile southwest of the southern park boundary). These ponds are within the projected disposal plume, and may begin to become more brackish, then saline, after some years. The length of time would depend upon the rate of development of HOST Park and NELH facilities. Assuming that incremental development of the park occurs, the effects of the plume 1.5 miles from HOST Park would be noticeable in approximately 10 to 30 years.

Vegetation could also be affected by the increased salinity of the groundwater, particularly deep-rooted trees at the shoreline such as kiawe now growing in several areas.

Surge loads of acids and chemicals are not likely due to the nature of mariculture operations. Because aquaculture products are primarily intended for human consumption, only FDA approved additives and chemicals can be used. Any surge loads that would occur would be highly diluted by the immense quantities of ocean water return and would have insignificant, undetectable effects. Acids would be buffered immediately by the ocean water and would have minimal effects.

Of potential importance are the effects of the seawater return flow as it seeps into nearshore waters. Although some pretreatment will be required by users, the return waters could be high in ammonia, other nutrients, suspended particulate matter and dissolved organic compounds. Effects on the nearshore waters would be

tempered because disposal into the groundwater and the relatively long residence time before a slug reaches the coast will provide a natural treatment process. Particulates will be filtered out; chlorine and any other treatment chemicals will be greatly diluted. Organics will be broken down through bacterial action.

Although nutrient loading has the potential to create biostimulation, benthic algae are very closely cropped by herbivorous fish. It could be assumed that this pattern would continue, and the biomass response would be seen at the herbivore or higher trophic level, not at the producer level. If the phytoplankton were stimulated, the natural flushing and circulation of this area, coupled with the lag between nutrient uptake and phytoplankton growth, would result in relatively slight stimulation over a large area. The biomass effects would most likely be seen at higher trophic levels.

The most serious potential impact arises from the temperature and density of the seawater return flow. Typically in this area, the groundwater discharge consists of brackish water which, although cold, because of its low salinity, is significantly less dense than the receiving waters and thus tends to flow seaward in a surface lens. If this flow is replaced with seawater of about ambient salinity but significantly cooler temperature compared to the receiving water, this denser return flow will form a bottom layer rather than a surface layer. Because this water will be cooler than ambient, detrimental effects could be experienced by the coral community. Corals are very temperature sensitive, and the typical temperatures of Hawaiian waters do not provide a great margin for reduction. If the seawater return flows consist solely of cold (10°C) water, corals could be killed for some distance along the coast, depending on plume advection.

One way to mitigate the potential negative effects is by warming the seawater before it is discharged. There will be some warming due to the mixing of cold and warm water on site. Temperatures of approximately 19°C and would be sufficiently warm to avoid coral mortality.

The problem can be alleviated by setting up a system to warm the water before discharge. If seawater return flows are conveyed by lined open ditches to the central disposal areas, rather than piped, the water could be sufficiently warmed before disposal. Alternatively, the water can be retained for a period of time before discharge to allow warming by sunlight, either by reusing the water for warm water aquaculture or in holding ponds.

3.4.4 Recommendations

The magnitude of injection is such that there is little or no difference in environmental effects between disposal by trenches or by wells. Clogging will occur for either trenches or wells because maricultural use will result in nutrients, entrained air, and suspended solids, all contributors to primary clogging or secondary biological fouling. Maintenance and/or replacement will therefore be required for both schemes. Although deep well disposal is likely to be less affected by secondary biological fouling, maintenance of surface trenches, probably consisting of periodic regrading of the trench bottom, is expected to be easier and less expensive than maintenance and/or replacement of wells.

If on-land disposal is selected as the method of seawater return flow disposal, the decision should be based primarily on cost effectiveness and ease of maintenance.

Based on these criteria, disposal by surface trenches is recommended for the following reasons:

Costs for trench construction are estimated to be 13 to 15 times less than well construction; and,

Maintenance of surface trenches, probably consisting of periodic regrading of the trench bottom, is expected to be easier and less expensive than maintenance and/or replacement of wells.

To minimize clogging and potential adverse environmental effects from chemicals or other substances added to maricultural operations, it is recommended that each user of ocean water be responsible for treatment before the return water is diverted to the disposal area. At the disposal area, filtration beds and lined settling ponds can be added to filter out solids and remove entrained air before the returned water is entered into the disposal system.

A water quality monitoring program should be implemented to obtain factual data on the effects of on-land seawater disposal. Based on the estimated time for the disposal plume to reach the shoreline of 6 months to 3.6 years after the start of HOST Park initial activities, it is believed that a minimum 4 year monitoring program would provide invaluable technical data to further improve the on-land disposal concept.

The water quality monitoring program should include periodic water level measurement and water sampling and analysis at the disposal area, at two or more on-land locations downstream of the disposal area, and at several locations along the shoreline and offshore. Basic water quality parameters to be collected include temperature, salinity, turbidity, nutrient content, fecal content, and other pertinent information such as disposal rates, precipitation, tides and evapotranspiration. The monitoring program should be developed in coordination and cooperation with DOH. Monitoring and analysis could be done by the NELH laboratory.

If and when it appears that the impacts of on-land disposal are unacceptable, other means of disposal such as outfalls can be used to discharge the seawater to the ocean. This would require outfall pipes equal in size and number to the intake pipes, doubling the adverse impacts associated with pipe construction and presence in the shoreline.

If on-land disposal is terminated for any reason, the effects on the aquifer are completely reversible; within a short period of time the aquifer will return to its original state, as will any affected anchialine ponds or vegetation.

4.0 Sanitary Wastes

The quantity of domestic sewage to be generated is estimated at 460 gallons/acre/day. For the 547-acre (460 developed) HOST Park, approximately 211,000 gpd would be generated. Each tenant will be responsible for his own sewage collection, treatment and disposal. Septic tanks and leaching fields will be used to protect the groundwater. Any remaining sewage that is percolated down to the groundwater would be insignificant compared to the projected volume of the ocean water plume.

Sewage effluent entering the groundwater regime between the ocean water discharge plume and the ocean would be discharged at the shoreline. Prior to discharge, the effluent would be significantly diluted by the large quantities of flowing ocean water return, and would be somewhat filtered and biologically digested during its residence time in the subsurface.

Sewage entering the groundwater regime mauka of the seawater disposal area would likely be carried inland and laterally some distance along the coastline before final discharge to the ocean. The resulting extended residence time (many years), and resulting high degree of filtering and biological digestion, would minimize any effects on the ocean.

5.0 Laboratory, Industrial and Process Wastes

Liquid and solid wastes, such as sewage, grease, oil, and laboratory chemicals (toxic or otherwise) will be handled either by the individual tenants or by a separate system. There will be no ground discharge without prior pretreatment to remove toxic substances.

Catastrophic events such as tsunamis and hurricanes could impact the marine environment by causing organisms or chemicals to be released into coastal waters. The effects of these introductions are unknown at the present time.

F. SOCIO-ECONOMIC IMPACTS

1.0 Socio-Economic Profile

The following is summarized from a report prepared by Decision Analysts, Hawaii, Inc. and Community Resources, Inc. (see Appendix G for complete descriptions).

1.1 North Kona District:

Until the 1960s, North Kona's economy was dominated by agricultural activities; the majority of its population was supported by independent farming or ranching operations. Other than a few moderately-large ranches, North Kona had few major employers for the first half of the 20th century.

During the 1970s, North Kona was the site of significant resort construction and became the island's fastest-growing district. By 1980, its population had increased 184 percent to 13,748, with the largest concentration (4,751) living in Kailua. (The Hawaii State Census Statistical Areas Committee estimates a January 1983 North Kona population of 16,266, which suggests slower growth during the less prosperous early 1980s.)

Table 4-3 indicates that there were a number of shifts in the district's demographic profile between 1970 to 1980. The Japanese proportion of the population declined sharply, and the ongoing in-migration of Caucasians from the Mainland made this district the only area on the island to have a Caucasian majority.

As shown in Table 4-4, North Kona residents in 1980 were less likely than other Big Island residents to live in family households (reflecting the influx of young single people). In the district, family median incomes were high and poverty rates were low. Although North Kona experienced a low overall unemployment rate, the district's 72 percent labor force participation rate was the highest on the island. The occupational and industry profile for North Kona's labor force differed from islandwide figures in several ways: proportionately more people were engaged in a service occupation/industry or retail trade; fewer in agriculture, manufacturing, or professional activities (Table 4-5). Housing costs were much higher in North Kona than elsewhere on the Big Island (Table 4-6) and proportionately more households were rented rather than owned.

Population growth will probably continue to reflect economic opportunities, primarily in the visitor industry. From June 1980 to February 1985, the number of visitor-oriented hotel and condominium units in Kona (including a very few in South Kona) increased by nearly 1,000, and the 1985 Kona total of 4,748 represented 63 percent of the island's visitor plant inventory. Virtually all this growth was in condominium units; the number of hotel properties, which produce more direct per-unit employment, was unchanged in nearly five years (Hawaii Visitors Bureau, 1980, 1985).

The draft Kona Regional Plan (Hawaii County Planning Department, 1982, 1983) assumes there will be continued high growth rates in West Hawaii resort units and that tourism will continue to dominate the economy. The county, however, does not make a definite forecast as to whether the growth will take place relatively more in Kona (the leader in the 1960s and 1970s) or in Kohala (the leader in the

TABLE 4-3

Total Population and Demographic Breakdowns: State of Hawaii, County of Hawaii, and Possible Affected Areas, 1970 and 1980

	STATE OF HAWAII		COUNTY OF HAWAII		NORTH KONA (C.T. 215-216) 1970 1980		SOUTH KONA (C.T. 213-214) 1970 1980		SOUTH KOHALA (C.T. 217) 1970 1980	
	1970	1980	1970	1980	1970	1980	1970	1980	1970	1980
TOTAL POPULATION	769,913	964,691	63,468	92,053	4,832	13,748	4,004	5,914	2,310	4,607
ETHNICITY*										
Caucasian	38.8	34.4	28.8	35.0	44.0	53.8	17.7	30.0	39.2	46.5
Japanese	28.3	24.9	37.5	26.6	23.1	11.8	39.6	27.5	24.4	14.5
Chinese	6.8	5.8	2.9	1.7	3.7	1.6	0.8	0.8	1.3	1.4
Filipino	12.2	13.7	16.5	13.9	8.4	7.2	26.2	13.0	6.6	5.6
Hawaiian	9.3	12.3	12.3	18.8	19.3	22.1	14.7	23.5	26.4	28.5
Other	4.6	9.0	2.0	4.1	1.5	3.5	1.0	5.2	2.0	3.4
AGE										
Less than 5 yr.	9.2	8.1	8.6	9.1	9.1	9.1	9.0	9.8	9.3	10.2
5 - 17 yr.	26.6	20.5	27.8	21.5	27.0	20.3	29.8	20.7	28.3	23.6
18 - 64 yr.	58.5	63.5	54.4	59.2	55.7	63.9	48.9	58.8	56.1	58.6
65 or more yr.	5.8	7.9	9.2	10.2	8.2	6.7	12.4	10.6	6.4	7.7
Median age	25.0 yr	28.4 yr	28.9 yr	29.4 yr	28.6 yr	28.9 yr	29.7 yr	29.7 yr	28.1 yr	29.3 yr
PLACE OF BIRTH*										
Hawaii	NC	57.8	NC	70.5	NC	54.4	NC	71.2	NC	64.9
Other U.S.**	NC	28.0	NC	20.0	NC	39.9	NC	20.8	NC	30.4
Foreign country	NC	14.2	NC	9.4	NC	5.7	NC	7.8	NC	4.7
RESIDENCE 5 YRS. PREVIOUS* (people aged 5+)										
Same house	46.0	49.3	62.5	52.9	51.1	38.8	56.1	57.4	45.6	50.7
Same island	NC	25.2	NC	24.9	NC	28.1	NC	22.9	NC	17.3
Different island	NC	2.8	NC	8.1	NC	7.0	NC	6.5	NC	14.9
Different state	NC	16.9	NC	11.1	NC	23.1	NC	10.7	NC	16.4
Different country	NC	5.7	NC	3.1	NC	3.0	NC	1.2	NC	0.7
EDUCATION* (selected - people aged 25+)										
0-8 years only	24.8	16.2	37.2	20.1	28.9	8.0	26.1	23.6	24.1	8.6
Hi school only	35.9	35.1	31.6	35.5	66.0	40.9	21.9	33.8	34.2	37.0
College, 4+ yr.	14.0	20.3	7.5	15.2	8.8	18.8	6.4	12.4	13.1	20.7

Notes: *Figures based on 15% sample; hence, numbers represent estimate.

**Including persons born in U.S. territories, and persons born abroad or at sea to American parent/s.

"NC" = 1970 categories or bases "Not Comparable" to 1980 (1970 Census kept a "non-response" category, while 1980 Census allocated non-responses to other categories shown).

Sources: U.S. Bureau of the Census, 1970 Census of Population and Housing--Hawaii, Honolulu, Hawaii, PHC(1)-88; 1980 Summary Tape Files 1-A and 3-4; State of Hawaii, 1973, Community Profiles for Hawaii.

TABLE 4-4

Family Characteristics and Income Levels: State of Hawaii, County of Hawaii, and Possible Affected Areas

	STATE OF HAWAII		COUNTY OF HAWAII		NORTH KONA (C.T. 215-216) 1970 1980		SOUTH KONA (C.T. 213-214) 1970 1980		SOUTH KOHALA (C.T. 217) 1970 1980	
	1970	1980	1970	1980	1970	1980	1970	1980	1970	1980
POPULATION IN FAMILIES	N/A	831,810	N/A	81,728	N/A	11,543	N/A	5,235	N/A	4,114
as percentage of total population	N/A	86.2%	N/A	88.8%	N/A	84.0%	N/A	88.5%	N/A	89.3%
NUMBER OF FAMILIES	170,358	227,974	14,533	22,825	1,131	3,339	848	1,378	533	1,204
HEAD										
Husband/wife	86.8	82.9	87.1	82.1	87.4	84.0	88.3	83.4	90.1	79.7
Male only	3.9	4.6	5.2	5.2	4.1	4.7	4.4	6.1	3.6	7.6
Female only	9.3	12.5	7.7	12.7	8.5	11.4	7.3	10.5	6.4	12.7
WITH OWN CHILDREN UNDER 18										
Female head	62.1	54.4	57.4	52.7	53.4	54.4	59.3	51.5	63.2	51.6
	5.8	7.4	4.0	7.4	5.0	4.8	3.5	5.4	4.5	9.1
BELOW POVERTY LEVEL	7.7	7.8	9.7	10.3	13.0	8.0	17.3	9.8	11.8	5.7
MEDIAN FAMILY INCOME	\$11,554	\$22,750	\$9,750	\$19,132	\$9,000 to \$9,999	\$21,100 to \$21,999	\$10,000 to \$11,999	\$19,128	\$9,182	\$17,924

Notes: All figures (except "Population in Families") based on 15% sample; hence, numbers represent estimates. "N/A" = "Not Available" in published form. However, other published 1970 and 1980 census data lead to the conclusion that families generally comprised a smaller percentage of Hawaii's 1970 population than of the 1980 total.

Sources: U.S. Bureau of the Census, 1970 Census of Population and Housing--Census Tracts--Honolulu, Hawaii, PHC(1)-88; 1980 Summary Tape File 3-A; State of Hawaii, 1973, Community Profiles for Hawaii.

TABLE 4-5

Labor Force Size and Characteristics: State of Hawaii, County of Hawaii, and Possible Affected Areas, 1970 and 1980

	STATE OF HAWAII		COUNTY OF HAWAII		NORTH KONA (C.T. 215-216)		SOUTH KONA (C.T. 213-214)		SOUTH KOHALA (C.T. 217)	
	1970	1980	1970	1980	1970	1980	1970	1980	1970	1980
POTENTIAL LABOR FORCE (aged 16+)	522,018	723,479	43,075	67,205	3,632	10,115	2,629	4,265	1,446	3,290
not in labor force	34.1%	31.7%	39.5%	38.7%	44.3%	27.8%	41.6%	33.8%	34.2%	35.9%
armed forces	9.5	8.1	0.4	0.3	0.0	0.1	0.0	0.0	0.0	0.0
civil. labor force	56.4	60.2	60.1	61.0	55.7	72.1	58.4	66.2	65.8	64.1
CIVILIAN LABOR FORCE	294,484	435,780	25,889	41,006	2,022	7,293	1,535	2,823	951	2,110
unemployed	3.0%	4.7%	2.7%	7.0%	4.8%	5.2%	2.3%	5.7%	4.1%	6.3%
TOTAL EMPLOYED	285,556	415,181	25,180	38,150	1,925	6,913	1,500	2,662	912	1,978
CIVIL. LABOR FORCE	15.4%	17.9%	16.3%	16.5%	19.3	21.5%	16.0%	17.3%	15.9%	18.0%
service manager./profes. technical, sales & adminis.	NC	23.5	NC	20.0	NC	21.2	NC	13.6	NC	20.6
farm/fish/forest & adminis.	NC	32.0	NC	26.1	NC	28.2	NC	24.8	NC	19.2
precision, craft, repair operators, fabri-	NC	3.4	NC	10.3	NC	7.1	NC	19.5	NC	14.0
cators, laborers	NC	11.6	NC	12.7	NC	12.1	NC	14.8	NC	16.5
	NC	11.7	NC	14.4	NC	9.9	NC	10.0	NC	11.8
INDUSTRY (selected)										
agric., forest, fish, mining	4.7%	3.6%	12.5%	11.2%	N/A	6.2%	N/A	19.4%	N/A	16.8%
construction	9.3%	7.2%	10.6%	9.1%	23.6%	11.2%	20.4%	14.3%	13.6%	12.3%
manufacturing	10.9	7.9	15.0	8.3	1.0	1.9	3.2	1.2	2.3	5.1
retail trade	17.4	19.9	14.8	17.5	13.1	23.6	8.9	18.4	15.9	13.8
financial, insur., real estate	5.0	7.6	2.8	5.7	4.0	8.6	3.5	4.5	3.5	7.6
personal, entertain. & recreat. services	8.5	9.2	11.2	10.9	N/A	20.7	N/A	15.2	N/A	16.0
health, educ, & professional	17.2	17.7	14.1	16.7	7.8	11.4	18.3	13.1	13.9	14.8
public adminis.	11.4	10.0	6.5	7.3	4.2	2.7	3.7	4.8	3.1	2.1
COMMUTE TO WORK										
45 minutes or more	N/A	13.5%	N/A	9.0%	N/A	4.8%	N/A	6.8%	N/A	13.9%
mean travel (min.)	N/A	21.5 m	N/A	16.5 m	N/A	16.4 m	N/A	20.6 m	N/A	21.7 m

Notes: All figures based on 15% sample; hence, numbers represent estimates. "N/A" = "Not Available" in published form. "NC" = 1970 category or base "Not Comparable" to 1980 Census. Source: U.S. Bureau of the Census, 1970 Census of Population and Housing - Census Tracts - Honolulu, Hawaii, PHC(1)-88; 1980 Summary Tape File 3-A; State of Hawaii, 1973, Community Profiles for Hawaii.

early 1980s -- see below). Rather, the plan presents three alternative projections for the year 2000:

- o Alternative I assumes no further North Kona hotel construction and construction only of already-approved condominiums. This leads to a year 2000 figure of 2,940 "occupied" Kona resort units (no total-available unit count is given), and an estimated resident population of 33,200 for North and South Kona combined.
- o Alternative II assumes complete development of the Keauhou Resort complex and some additional condominiums. The year 2000 figures are for 4,500 occupied units and 39,400 residents for the combined Kona areas.
- o Alternative III assumes continuation of Kona's historical growth rates prior to the 1980's. This would result in 5,700 resort units in the year 2000, as well as an estimated 46,300 resident population for the combined Kona areas.

1.2 South Kona District:

The economy of the South Kona district is based on scattered ranch and farming operations, retail activity in the small settlements, fishing, and nonresort operations catering to sight-seers (such as marine recreation at Kealekekua Bay or the City of Refuge National Park at Honaunau). Many residents commute to jobs in North Kona hotels.

The district's 1980 population of 5,914 (including 3,041 concentrated in the principal communities of Captain Cook and Kealekekua) represented a 48 percent increase over the 1970 population; approximately the same growth rate as that experienced by the island as a whole. The estimated January 1983 South Kona population was 6,457 (Hawaii State Census Statistical Areas Committee, 1984).

South Kona has experienced lesser Mainland in-migration than North Kona. As shown in Table 4-3, the demographic changes which took place during the 1970s made South Kona's population more similar to the islandwide population in 1980 than it had been before -- particularly in regard to age structure, mobility, and ethnicity. Trends, however, would suggest a continuing decline in the proportions of Japanese and Filipinos, two groups which tend to be aging on average. Average educational levels in South Kona improved only slightly from 1970 to 1980, dropping behind countywide standards.

Family structure and income patterns were essentially identical to islandwide ones in 1980 (Table 4-4). This indicates a substantial drop in poverty rates since 1970, although it is difficult to say whether this reflected greater prosperity for longtime residents or in-migration of more affluent people. South Kona's 1980 unemployment rate was lower than the islandwide one, and its labor force participation rate higher (Table 4-5). The 1980 labor force profile shows much higher proportions of workers involved in agriculture or fishing in South Kona than in either North Kona or the overall island, with service-worker percentages lower than in North Kona but higher than the countywide average. South Kona residents had to commute longer distances to their jobs than did North Kona workers, suggesting substantial out-of-district employment.

As of 1980, housing costs, particularly rents, were lower than in North Kona but there were fewer rental vacancies, more crowded households, and substantially more old structures lacking some or all plumbing (Table 4-6).

1.3 South Kohala District:

Until the mid-1960s, South Kohala's economy centered on ranching, particularly the Parker Ranch headquartered in the district's principal town of Waimea (also called Kamuela). In 1965, tourism began to bring economic prominence to the coastal regions with the opening of the 310-room Mauna Kea Beach Hotel. The 1970s saw construction of the Queen Kaahumanu highway to North Kona, development of the Lalamilo water system, expansion of the Waikoloa resort-residential subdivision south of Waimea, and the establishment of numerous second homes and an observatory base camp in Waimea itself.

New resort hotels located in South Kohala in the 1980s. The 543-room Sheraton Royal Waikoloa opened in 1981; the 351-room luxury Mauna Lani Bay Hotel started operations in 1983; and the government approval process is for another 350-room hotel near the Mauna Kea and a 1,250-room "Disneyland-style" Hyatt hotel at Waikoloa. There are plans or proposals for another 3,266 hotel and 4,369 condominium units on the Kohala coast (possibly including portions of North Kohala) (Hawaii Visitors Bureau, 1985), more than twice the number of contemplated additional North Kona units. The county's draft Kona Regional Plan projects a total of 10,500 "occupied" resort units in Kona and Kohala combined by the year 2000. For the three previously-listed alternative futures for Kona, it is assumed that new units not built in Kona would go in Kohala.

As shown in Table 4-3, South Kohala's population doubled from 2,300 in 1970 to 4,600 in 1980, with most of that growth in or around either Waimea or Waikoloa. The estimated January 1983 population was 5,271 (Hawaii State Census Statistical Areas Committee, 1984). South Kohala's largely Caucasian and Hawaiian population grew even more so during the 1970s. Other changes attributable to recent in-migration include a sharp jump in average educational levels and higher proportions of people either born on the mainland or living there five years previously than was the case islandwide.

2.0 Socio-Economic Impact Analysis

2.1 Construction Employment

2.1.1 Existing Situation

Table 4-5 indicates that as of 1980 unemployment in North Kona was low and the labor force participation rate was high. According to the 1980 U.S. Census (Summary Tape File 3-A), there were an estimated 1,400 construction industry employees in North and South Kona and South Kohala. Slightly more than half of these employees resided in North Kona. Since 1980, the West Hawaii construction industry has been occupied primarily in the completion of several South Kohala hotels and a number of North Kona condominium projects.

2.1.2 Impacts

Table 4-7 projects anticipated construction employment for NELH and HOST Park under the 3 development scenarios.

Assuming that both NELH and HOST can, in fact, be developed fully over 10 years, then average construction employment will average about 73 to 150 jobs, depending on whether the development is based more on aquaculture or buildings/support activities. Direct plus indirect employment would average about 183 to 375 jobs, with about 88 to 180 jobs in West Hawaii. Because of uneven development over time, actual employment can be expected to deviate greatly from average employment.

Since the construction industry is expected to grow only modestly over the next decade, most construction workers probably would be hired locally or employed on temporary assignment from Oahu or possibly Maui. It is expected that the skills needed for construction of most of the improvements described for HOST Park and NELH will be available in the West Hawaii or county labor force. The indirect jobs would be distributed throughout the economy with most located in Honolulu, which is the government, service, and distribution center for the state.

Salary levels for both the direct construction jobs and the indirect jobs are higher than the statewide average of about \$16,880. Under the given assumptions, total household income generated by construction would average \$4.3 to \$8.9 million per year.

2.2 Permanent Employment

2.2.1 Existing and Projected Situation

Tables 4-3 and 4-5 present the existing population and employment situation for the West Hawaii Region. Tables 4-8 and 4-9 estimate the project induced employment and population effects of the projected development.

2.2.2 Impacts and Mitigating Measures

Assuming full and intensive development of NELH and HOST, onsite employment will total 1,590 to 3,580. Lower employment will occur with greater aquaculture development since fewer jobs per acre are generated than is the case with buildings. Employment may even be less if low-intensity aquaculture were to develop.

Inasmuch as some of the indirect support jobs generated by aquaculture can be expected to locate in HOST, direct employment is expected to be somewhat less than total onsite employment.

The indirect jobs would be distributed throughout the economy with most located in Honolulu which, as mentioned previously, is the government, service, and distribution center for the state.

Salary levels for semi-skilled, skilled, and professional workers can be expected to be above average, with unskilled workers having below-average wages.

Table 4-7 -- Average Annual Construction
Employment and Income¹

Item	HOST Scenario for Pond Area		
	A Maximum	B Medium	C Minimum
Direct Jobs:			
Pipes ²	3	3	3
HOST:			
Commercial Area ³	9	9	9
Buildings/Support Services ⁴	30	70	118
Aquaculture and Other Ocean-water Activities ⁵	19	14	8
NELH:			
Office Area ⁶	3	3	3
Aquaculture and Solar Ponds ⁵	<u>9</u>	<u>9</u>	<u>9</u>
Total Direct Jobs	73	108	150
Direct plus Indirect Jobs⁷	183	270	375
West Hawaii ⁸	88	130	180
Elsewhere	95	140	195
Average Salary (1984 dollars):			
Direct Construction Jobs	\$26,560	\$26,560	\$26,560
Indirect Jobs	\$21,900	\$21,900	\$21,900
Total Household Income (million 1984 dollars)	\$ 4.3	\$ 6.4	\$ 8.9

¹ Assumed 10-year development period. Actual construction employment will vary greatly from average employment.

² 10 pipes, construction crew of 10, 4-month construction period.

³ 30 man-years/acre.

⁴ 4 man-years/acre.

⁵ 0.5 man-years/acre.

⁶ 10 man-years/acre.

⁷ 2.5 direct plus indirect jobs per direct job.

⁸ 1.2 times direct jobs.

Table 4-8 -- Operating Employment and Income,
Full Development

Item	HOST Scenario for Pond Area		
	A Maximum	B Medium	C Minimum
Onsite Jobs:			
HOST:			
Commercial Area and Support ¹	65	65	65
Buildings/Support Services ²	750	1,750	2,960
Aquaculture and Other Ocean-water Activities ³	385	285	165
NELH:			
OTEC, Lab, Offices ⁴	25	25	25
Aquaculture:			
Committed Lands ⁵	120	120	120
R&D, Small Parcels ⁶	180	180	180
Commercial, Large Parcels ³	18	18	18
	to	to	to
	60	60	60
Solar Ponds ⁴	2	2	2
	to	to	to
	4	4	4
Total Onsite Employment ⁷	1,590	2,490	3,580
Skilled and Professional ⁸	400	620	900
Semi-skilled ⁸	630	1,000	1,430
Unskilled ⁸	560	870	1,250
Direct Jobs ⁹	1,480	2,390	3,500
Direct plus Indirect Jobs ¹⁰	2,520	4,060	5,950
West Hawaii ¹¹	1,780	2,870	4,200
Elsewhere	740	1,190	1,750
Average Annual Salary (1984 dollars):			
Direct Jobs: ¹²			
Skilled and Professional	\$30,000	\$30,000	\$30,000
Semi-skilled	\$20,000	\$20,000	\$20,000
Unskilled	\$15,000	\$15,000	\$15,000
Indirect Jobs ¹³	\$16,880	\$16,880	\$16,880
Total Annual Household Income (million 1984 dollars)	\$48.7	\$78.2	\$114.4

**Table 4-8 -- Operating Employment and Income,
Full Development
(continued)**

- ¹Includes 3 guards, 1 visitor center employee, 2 guides, 40 restaurant employees, 6 snack bar employee, 2 convenience-shop employees, 3 office workers, 3 grounds-keepers, and 5 support professionals.
- ²10 jobs/acre.
- ³1 employees/acre.
- ⁴Direct estimate.
- ⁵Current plans: 100 for Hawaiian Abalone Farms, 20 for Cyanotech.
- ⁶3 jobs/acre.
- ⁷Based on maximum aquaculture development.
- ⁸25% skilled and professional, 40% semi-skilled, and 35% unskilled.
- ⁹Indirect jobs generated by aquaculture and located in the building/support services area are assumed to equal 15% of total aquaculture jobs; hence direct jobs = total onsite jobs - 15% of aquaculture jobs.
- ¹⁰1.7 times direct jobs, reflecting vertical integration.
- ¹¹1.2 times direct jobs.
- ¹²Assumed.
- ¹³State average.

Table 4-9 -- Population and Housing, Full Development

Item	HOST Scenario for Pond Area		
	A Maximum	B Medium	C Minimum
Population	5,040	8,120	11,900
West Hawaii	3,560	5,740	8,400
Elsewhere	1,480	2,380	3,500
Housing	1,680	2,710	3,970
West Hawaii	1,190	1,910	2,800
Elsewhere	490	800	1,170

¹ 2 people per job.

² 3 people per home.

In addition to increased employment and income, expansion of NELH and the development of HOST will contribute to a more diversified and stronger economy for West Hawaii, Hawaii County, and the state.

Given high Big Island unemployment rates, the state and (particularly) county governments have expressed concern that any economic development projects initiated in West Hawaii lead to as much employment as possible going to longtime residents.

Thus, the primary objective is to maximize employment for longtime West Hawaii residents, with secondary consideration for needy longtime residents of other Hawaii areas. Mandatory local-hiring requirements for commercial tenants would not be feasible or desirable, and so the principal methods for attaining this objective would involve training and education--including in-service upgrade--to increase the competitiveness of longtime residents. Supporting strategies might include community awareness efforts and employer incentive programs. Potential elements for such programs are discussed in Appendix G. Briefly, they are:

- o community outreach to stimulate awareness and interest, especially among young people;
- o establishment of an advisory committee or some other structure to assure linkages with the available resources;
- o use of these linkages to solicit and screen job applicants for NELH/HOST employers, and to encourage development of needed educational programs which are identified as necessary for improving the competitiveness of longtime residents for jobs;
- o internships or summer job programs for young people;
- o facilitating in-service upgrade training programs of benefit to several different commercial tenants;
- o efforts -- perhaps involving coordination of tenant contributions toward a scholarship fund -- to encourage and guide capable young residents to educations preparing them for ultimate promotion to top professional and management jobs.
- o hold a conference within the first year after the opening of HOST Park to help establish linkages and begin to formulate a more specific plan. Conferees should include appropriate resource agencies; tenants and potential tenants; and NELH/HOST administrators. The conference might also include other Big Island scientific and technical employers, such as astronomy research operations. It is unlikely that this early gathering would produce an exact plan for implementation, but it should result in an overall strategy and timetable for developing the program.
- o investigate the possibility of implementing a program of employer incentives for participating in a centralized program for job recruitment and screening, in-service upgrade training, scholarships, etc.

In addition to increased employment and income, expansion of NELH and the development of HOST will contribute to a more diversified and stronger economy for West Hawaii, Hawaii County, and the state.

Given high Big Island unemployment rates, the state and (particularly) county governments have expressed concern that any economic development projects initiated in West Hawaii lead to as much employment as possible going to longtime residents.

Thus, the primary objective is to maximize employment for longtime West Hawaii residents, with secondary consideration for needy longtime residents of other Hawaii areas. Mandatory local-hiring requirements for commercial tenants would not be feasible or desirable, and so the principal methods for attaining this objective would involve training and education--including in-service upgrade--to increase the competitiveness of longtime residents. Supporting strategies might include community awareness efforts and employer incentive programs. Potential elements for such programs are discussed in Appendix G. Briefly, they are:

- o community outreach to stimulate awareness and interest, especially among young people;
- o establishment of an advisory committee or some other structure to assure linkages with the available resources;
- o use of these linkages to solicit and screen job applicants for NELH/HOST employers, and to encourage development of needed educational programs which are identified as necessary for improving the competitiveness of longtime residents for jobs;
- o internships or summer job programs for young people;
- o facilitating in-service upgrade training programs of benefit to several different commercial tenants;
- o efforts -- perhaps involving coordination of tenant contributions toward a scholarship fund -- to encourage and guide capable young residents to educations preparing them for ultimate promotion to top professional and management jobs.
- o hold a conference within the first year after the opening of HOST Park to help establish linkages and begin to formulate a more specific plan. Conferees should include appropriate resource agencies; tenants and potential tenants; and NELH/HOST administrators. The conference might also include other Big Island scientific and technical employers, such as astronomy research operations. It is unlikely that this early gathering would produce an exact plan for implementation, but it should result in an overall strategy and timetable for developing the program.
- o investigate the possibility of implementing a program of employer incentives for participating in a centralized program for job recruitment and screening, in-service upgrade training, scholarships, etc.

2.3 Population Growth and Housing

2.3.1 Existing Situation

The average increase in housing units during the 1970s for North Kona and all of West Hawaii (North Kona, South Kona, and South Kohala) averaged 492 and 700 per year, respectively. Focusing only on units occupied year-round by residents (and eliminating second homes and units available to the visitor market), the average increase for Kona and West Hawaii was 317 and 480 per year, respectively.

Housing prices in Kona increased rapidly in the late 1970s, resulting in average home prices that were much higher than in Hilo and other areas of the Big Island. These price increases far outstripped reported family income, which is a particular concern given that the economic and population growth in Kona was driven by growth of the low-paying visitor industry. Also, the waiting list for homes offered by the Hawaii Housing Authority (HHA) was long, and a large number of homes were thought to be dilapidated based on the fact that many are over 50 years old. Since 1980, however, housing affordability has improved greatly.

2.3.2 Impacts and Mitigating Measures

Full and intensive development of NELH and HOST would support about 5,040 to 11,900 people in Hawaii, with 3,560 to 8,400 in West Hawaii and 1,480 to 3,500 elsewhere (see Table 4-9).

Even though companies at NELH and HOST can be expected to hire a number of people locally, the increased employment opportunities in West Hawaii will contribute to net immigration, since tourism development is expected to cause West Hawaii to be a labor-short area. It is assumed that if a local resident obtains a job at NELH or HOST rather than one in the visitor industry, then that job in the visitor industry is available to workers from outside the region. Similarly, if a local resident obtains a job at NELH or HOST rather than moving off-island, then out migrations is reduced. In either case, the result is an increase in net immigration. Given the above population supported by NELH and HOST and assuming a rapid 10-year development period, then the increase in the West Hawaii population contributed by the two developments will average about 356 to 840 people per year.

As with most new people moving into an area, the added population can be expected to be younger (20 to 30 years of age), to have more education, and to be more mobile than average. Furthermore, most will be single, and either from Oahu or the mainland.

Corresponding to the projected population increase generated by NELH and HOST, the two developments will provide support for 1,680 to 3,970 homes statewide, with 1,190 to 2,800 homes in West Hawaii, and 490 to 1,170 homes elsewhere. For West Hawaii, the increase would average about 119 to 280 homes per year, assuming full and intensive development within a 10-year period. For comparison, the average increase in housing units during the 1970s for North Kona and all of West Hawaii (North Kona, South Kona, and South Kohala) averaged 492 and 700 per year,

respectively. Focusing only on units occupied year-round by residents (and eliminating second homes and units available to the visitor market), the average increase for Kona and West Hawaii was 317 and 480 per year, respectively.

Community surveys conducted in 1976 and 1980 indicated that housing is a major concern with West Hawaii residents (County of Hawaii, Kona Regional Plan, 1982). The principal issue has been the high price of housing and problems of affordability.

For perspective, however, the following should be noted:

- High housing prices are correlated with healthy, growing economies, while low housing prices are correlated with unhealthy, declining economies.
- The rapid growth in housing prices in the late 1970s was part of a nationwide short-term upswing in the real estate price cycle.
- Even though housing prices increased greatly during the 1970s, housing in Kona improved in terms of a higher percentage of residents owning their own homes, fewer units lacking some or all plumbing, and less crowding (see Table 4-6).
- The extent to which the long waiting list for HHA homes indicated housing problems rather than housing bargains is unclear.
- The number of homes 50 years old or older that are dilapidated rather than old but well maintained is unknown.
- Some retirees may report low incomes, but may be able to afford relatively expensive homes because of accumulated wealth and/or unreported tax-exempt income.
- Some workers in the visitor industry thought to have severe affordability problems actually do not, inasmuch as over 25 percent of the workers in the visitor industry receive tip income and this income can be very substantial (e.g., waiters and waitresses in popular restaurants have been found to earn 3.5 times their reported income).
- The majority of workers who are dependent indirectly upon the visitor industry probably do not have severe affordability problems since most of these workers have higher than average incomes; their problems of affordability are probably similar to most other middle-income families in the state who live in an area having a healthy economy and relatively high housing prices.
- Some of the people holding lower paying jobs in the visitor and other industries are, in effect, on extended working vacations in Hawaii, and do not require high-quality permanent housing; the number of such workers appears to increase during periods of rapid expansion of the visitor industry.

- Some of the condominium units intended for but not rented to visitors have been made available to residents at bargain rental rates, considering the amenities provided; however, the number of such units made available to residents decreases during boom periods when additional housing is needed most.
- Since 1980, housing affordability has improved greatly; mortgage rates have dropped substantially and, as measured in constant dollars, single-family housing prices in Kona have dropped 38 percent (Locations, Inc., Hawaii Real Estate Indicators, April 1985). But similar to the increase in real estate prices in the late 1970s, the recent decline in housing prices has been part of a nationwide short-term down-swing in the real estate cycle. And even with lower mortgage rates and housing prices, problems of housing affordability still remain.

Regarding the future, however, West Hawaii is expected to have higher housing prices and increased problems of affordability. This can be expected throughout Hawaii County, the state and the nation as a result of a nationwide upswing of the real estate cycle. In addition, West Hawaii is expected to experience large jumps in construction and visitor-industry employment along with large jumps in housing demand as a result of developing or expanding the Hyatt, Mauna Kea, Kona Village, Mauna Lani and other resorts and hotels.

The contribution of the NELH and HOST projects to high housing prices in West Hawaii is expected to be comparatively modest since expansion is expected to be relatively gradual, and the bulk of the housing demand will be generated by growth in the visitor industry (over 825 residential units per year for Kona and Kohala; County of Hawaii, Kona Regional Plan, 1982). Furthermore, workers directly and indirectly dependent upon the NELH and HOST projects should be better able to afford housing in West Hawaii than those dependent on the visitor industry since, on average, those dependent on NELH and HOST will have higher wages.

A portion of the NELH and HOST workers may encounter problems of housing affordability. Mitigating measures designed to moderate the general increase in housing prices, many of which are given in the Kona Regional Plan, include:

- Increase the supply of developable land by liberal state districting and county zoning, and government development of roads, water, sewers, etc.
- Increase the supply of affordable housing by reducing lot sizes and allowing increased densities, thereby reducing the amount of land required for each home.
- Decrease construction costs by relaxing requirements for off-site and on-site improvements, allowing manufactured housing, and simplifying and shortening the permit approval process.

Mitigating measures designed to assist qualifying low- and moderate-income households include:

- Provide direct income supplements, including: (1) rent subsidies administered by the HHA; (2) mortgage supplements under the state Hula Mae Special Assistance Program; (3) and general financial assistance under a variety of programs administered by the Hawaii Department of Social Services and Housing.
- Provide low-interest mortgages to first-time home buyers financed with tax-exempt state and/or county revenue bonds.
- Exempt county property taxes.
- Provide, under State, County or Federal Housing Program, housing at below market rents or prices.
- Provide, under the State Housing Program, state land at below market rents or prices.
- Provide low-interest rehabilitation loans to correct deteriorated and hazardous conditions.

Unless otherwise stated, most of the resources required to implement these mitigating measures will come from the state and/or county general fund, or general obligation bonds. Tax revenues needed to cover the added expense will derive from the expanded economic activity made possible by the HOST Park. For the state, most revenues will derive from excise and income taxes paid by the higher-income employees. For the county, most tax revenues will derive from property taxes on HOST Park and commercial operators at NELH and on the homes of the higher-income employees.

Although increased employment generated by HOST and NELH may impact the West Hawaii housing market, unlike resort development, where the number of potential employees is known and where employees all come "on-board" at the same time, the contribution of the proposed projects is difficult to estimate. Mitigating measures, if required, will be developed in coordination with the County of Hawaii, Department of Housing and Community Development. In addition, the State of Hawaii, through the Hawaii Housing Authority, will take whatever appropriate actions are required in order to insure that the development of HOST Park and expansion of NELH does not exacerbate the West Hawaii housing situation.

3.0 Public Facilities

3.1 Schools

3.1.1 Existing Conditions

Konawaena Intermediate and High School serves both North and South Kona; its September 1984 enrollment for grades 7-12 was 1,439. (Enrollment figures in this section provided by Mr. Ed Matsushige, student demographic specialist, Hawaii State Department of Education.) Other public elementary schools in North Kona

include Kealakehe (grades K-8, enrollment 1,244), Konawaena Elementary (K-6, enrollment 613), Kahakai (K-5, enrollment 440), and Holualoa (K-6, enrollment 321). An additional 116 students were enrolled in the private International Christian School (grades K-11, with plans to add grade 12).

Other public elementary schools in South Kona are Honaunau (K-8, enrollment 362) and Hookena (K-8, enrollment 154). An additional 18 students were enrolled in the private Kona Adventist school (grades 1-8).

The only public school in South Kohala is the Waimea Elementary and Intermediate School (K-9, enrollment 835). For grades 10-12, students are bussed to the Honokaa High School in Hamakua. There are three private schools in and around Waimea: Kamuela Montessori Schools (K-3, enrollment 29), Parker School (7-12, enrollment 91), and the Hawaii Preparatory Academy (K-12, enrollment 580), which serves both local students and boarders from around the state.

3.1.2 Potential Impacts and Mitigating Measures

The State Department of Education usually does not predict future enrollment based on planning for possible developments in a region. Rather, it waits until such plans enter more concrete stages, such as zoning changes or the start of actual construction. Because of this, there is no long-term plan for new facilities. However, all West Hawaii public schools are considered to be operating at capacity (Howard Lau, planner, Hawaii State Department of Education, personal communication, June 1985), and expansion is therefore likely to take place with or without the proposed project.

The additional population supported by the NELH/HOST Park project would speed the trend for new school development. A rough estimate of the demand can be derived from 1980 Census figures, which indicate that 21 percent of the West Hawaii population consisted of children in the 5 - 17-year-old school-age range. This percentage may drop in the future due to declining birth rates and continued in-migration of childless subpopulation (young transients or retirees). Using the 21 percent figure as a liberal predictor, the project-supported additional population would include 1,058 school-aged children under Scenario A, including 748 in West Hawaii; 1,705 children under Scenario B, including 1,205 in West Hawaii; and 2,499 children under Scenario C, including 1,764 in West Hawaii.

At present, it cannot be predicted in which towns or districts the heaviest demand for new school facilities would be felt, nor can it be said how much of the demand would be for public (as opposed to private) school facilities. However, it is reasonable to assume that the projected 400 to 900 skilled and professional workers at the NELH/HOST Park facilities would be particularly interested in the well-established private school in South Kohala.

3.2 Health Care

3.2.1 Existing Conditions

A new 75-bed state-operated Kona Hospital in Kealahou is the primary health care facility for North and South Kona. It offers surgery and most other medical services not requiring highly specialized physicians or technology. South Kohala residents are served by the Lucy Henriques Clinic in Waimea (not a hospital, but

with two holding beds) and two state-operated hospitals in adjacent districts: the 26-bed Kohala Hospital in Hawi, North Kohala, and the 44-bed Honokaa Hospital in Hamakua. None of these facilities offer surgical services; they are oriented to stabilizing emergency patients until they can be moved to other hospitals.

3.2.2 Potential Impacts and Mitigating Measures

Hospitals serving West Hawaii generally operate at less than capacity but can be full on occasion. The State Health Department has received a \$200,000 long-term planning appropriation for either additions to the existing Kona Hospital or improvements on an additional site. There are also plans to rebuild the old wooden Honokaa Hospital which serves South Kohala residents. While anticipated resort-induced population growth will increase the need for acute care facilities, there may be an even greater need for long-term care due to the number of retirees moving to West Hawaii (Donald McGrath, administrative assistant to the Deputy Director, State Health Department, personal communication, June 1985).

While there are no official standards, health planners tend to use a "rule of thumb" which prescribes four hospital beds per 1,000 resident population. Thus, the additional resident population supported by the proposed project would require about 20 new beds, including 14 in West Hawaii, under Scenario A. Under Scenario B, the need would be for about 32 beds, including 23 in West Hawaii. And under Scenario C, the need would be for 48 beds, including 34 in West Hawaii. It cannot be presently determined whether the new West Hawaii beds would be in the form of additions to one or more existing hospitals, or whether a new facility will be required.

3.3 Fire Protection and Emergency Rescue

3.3.1 Existing Conditions

Residents of all three districts have 24 hour a day county fire protection services, 365 days a year. North Kona's fire station is located in Kailua. There are five vehicles operated by three shifts of 10 men each. At Captain Cook in South Kona, three shifts of six men each operate three vehicles, and a similar number of personnel and vehicles are based at the Waimea Fire Station in South Kohala. There are also three volunteer fire stations -- a two-truck station at the Kona Village resort complex in North Kona and two one-truck stations at Waikoloa and Puako in South Kohala.

Ambulance and emergency rescue are also Fire Department functions, and vehicles for these purposes are included in the foregoing counts. A State Airports Division emergency fire squad is also located at the Keahole Airport adjacent to the present NELH facilities, but equipment and personnel are restricted to airport situations.

3.3.2 Potential Impacts and Mitigating Measures

New county fire and emergency rescue facilities are usually planned in response to existing need rather than estimated future demand, although some discussion is now underway with South Kohala resort developers about the possibility of improved protection there. Need is a function not only of population but also of risk factors, and this makes it difficult to make concrete assessments of project impacts. The impact of the additional West Hawaii resident population would

depend not only on which development scenario most accurately projects population growth, but also upon timing of growth and distribution of population among the three West Hawaii districts under consideration. A concentration of population in South Kohala or North Kona would simply hasten the creation of new facilities needed to service the growth expected to take place anyway; a similar concentration of project-related population in South Kona is rather unlikely but would have a more obvious effect on fire and emergency facilities. In either event, the expanded population will require more protection, but at currently unknown locales, rates and levels.

The proposed new NELH/HOST Park facilities themselves would be located approximately 8-10 minutes away from the nearest fire station (in Kailua), which is considered adequate protection for the site itself (Albert Kaaihili, Kailua Fire Station rescue specialist, personal communication, June 1985).

3.4 Police Protection

3.4.1 Existing Conditions

North and South Kona comprise a single police district currently consisting of a total workforce of 71 (Inspector Robert Pung, Hawaii County Police Department, personal communication, June 1985). The district headquarters are in Captain Cook, with a substation in Kailua which serves as a check-in spot. The Captain Cook facilities are overburdened, and the Kona police also rent office space from private individuals. There are plans to move the district headquarters to a new office at Kealakehe, North Kona. Construction is scheduled to begin late this year or in early 1986, with opening in late 1987 or early 1988.

South Kohala is covered by a station in Waimea with 19 total personnel. This level of staffing is adequate to provide 24-hour protection when all officers are present, but illness or vacations periodically result in the station being shutdown during the midnight (11 p.m. to 7a.m.) shift.

Private security forces at major West Hawaii resorts supplement public police protection.

NELH presently shares the cost of a private security contract with its clients. It has yet to be determined whether private security for the HOST Park would be handled on a joint basis with NELH or separately through the state or the future tenants' association.

3.4.2 On-site Impacts and Mitigating Measures

County police officials have limited experience on which to base estimates of the types or amount of crime which can be expected on-site at an expanded NELH or new HOST Park; however, the most likely concerns would be burglary and vandalism (Inspector Robert Pung, Hawaii County Police Department, personal communication, June 1985). If public use of the beach recreational areas increases, there could also be some crime of the nature associated with beach parks -- larceny, public disturbances, and occasional assaults or rapes. When the Kona police station is moved from Captain Cook to Kealakehe in late 1986 or early 1987, the NELH/HOST site will be substantially closer to police headquarters than at present.

Demands for county police services at the project site would be mitigated by the continuation of current policies restricting public beach access to daytime hours and by private security arrangements.

3.4.3 Regional Impacts and Mitigating Measures

As with fire protection services, police facilities and personnel are expanded in response to documented need (i.e., reported crime and case loads) and not in response to anticipated new population or development. Thus, impacts can be estimated in only a rough and general way.

Additional police personnel will be required for the population which will be supported by the project. While the actual need will be determined by the crime generated by this population, a rough estimate can be made based on existing islandwide ratios of police personnel to population. For the four-year period from 1980 to 1983, data on authorized police personnel strength (Hawaii County Police Department, 1984) and estimated population (Hawaii State Department of Planning and Economic Development, 1985b) lead to average figures of 2.75 sworn officers and 0.64 permanent civilian employees -- for a total of 3.39 positions -- per 1,000 residents. (NOTE: Actual strength has usually been about 90 percent of authorized strength.)

Applying this average to the projected additional population associated with the project, Scenario A would require 17 additional authorized police personnel, including 12 in the three West Hawaii districts; Scenario B would require 27.5 new positions, including 19.5 in West Hawaii; and Scenario C would require 40 new positions, including 28.5 in West Hawaii. It should be noted that county police would consider the average 3.39 positions per 1,000 residents as somewhat inadequate because current staffing has been limited by budgetary considerations. If more county revenues become available for police protection, the additional population could result in more police personnel than indicated by the foregoing estimates.

3.5 Solid Waste Disposal

3.5.1 Existing Conditions

Solid waste collection is handled on a privately-operated basis on the Big Island. Refuse trucks in West Hawaii deliver the waste to sanitary landfills. (Only conventional solid waste is currently accommodated on the island; there are no hazardous waste disposal sites.) NELH currently shares private refuse collection costs with its tenants.

At present, all three West Hawaii districts are serviced by one county-operated sanitary landfill near Kailua. This landfill will be operational for three or four more years, until urbanization in the Kailua area will require it to be closed. At this time, the Sewers and Sanitation Bureau of the County Public Works Department plans to open a new solid waste landfill at Pu'uanahulu in North Kona (Harold Sugiyama, Director, Sewers and Sanitation Bureau, private communication, June 1985).

3.5.2 Potential Impacts and Mitigating Measures

Additional solid waste would be generated directly by NELH/ HOST Park tenants and indirectly by the additional population supported by the project under the various development scenarios. Collection from both sources would be on a privately-sponsored basis. Within the HOST Park, this would probably be handled on a contractual basis through the tenants' association. NELH's arrangement to share refuse collection costs with its tenants is likely to continue as facilities expand, although it is also remains to be worked out whether NELH and the HOST Park could arrange a joint refuse collection arrangement.

A matter for particular attention in the future is improved refuse bins or trash cans at the beach recreational areas.

According to the director of the county's Sewers and Sanitation Bureau (Harold Sugiyama, private communication, June 1985), the new Pu'uanahulu landfill scheduled to open in North Kona during the late 1980's is large enough to offer an indefinite lifespan. The director sees no problem in accommodating the additional solid waste.

G. SOCIO-CULTURAL ATTRIBUTES AND RECREATION RESOURCES

1.0 Historical/ Archaeological Sites

1.1 Historical Background

According to the Department of Land and Natural Resources Historic Preservation Office, based on current interpretations, the HOST/NELH area was probably settled in the A.D. 1400s. As stated in an attachment to their comments on the Notice of Preparation for this EIS (Part VIII):

It (the area) had a small population prehistorically and an even smaller population in early historic times. A few permanent dwellings were along the shore with numerous temporary habitations (e.g., shelter caves and C-shaped shelters) just behind or along the shore. Trails led inland across the barren pahoehoe flows to the agricultural fields situated at about the 800 - 2200 foot elevations. Along these trails, there were shelters (caves, C-shaped enclosures, etc.) and cairns, the latter apparently marking the trails and shelters. Major trails crossing through these lands parallel to the shore were the prehistoric/historic coastal trail (the 20th Century jeep trail) and the historic period Mamalahoa Trail.

1.2 Existing Conditions

Eight archaeological surveys have been done in the HOST Park parcel, and 7 have been done in the NELH parcel. More surveys are listed in Appendix I. These surveys included intensive surveys and excavations. The HOST Park and NELH parcels contain archaeological sites along the coast and lower barren pahoehoe areas. Nearly all sites fitting permanent housing criteria along the coast have been carefully mapped, minimally excavated, and minimally dated. Smaller sites have been mapped in detail, excavated and dated only along the NELH access road. Deposits were generally shallow and limited. Most smaller sites have not been mapped in detail, nor have they been excavated in cases where deposits are present.

1.2.1 HOST Park Site

The most recent reconnaissance survey of the HOST Park site was conducted by Chiniago, Inc. in January 1985. Although the archaeologist reported locating 45 sites on the property, the number was corrected to 44 by DLNR. In addition, because DLNR was in the process of updating their site numbering system at the time of the survey, Chiniago, Inc. was not able to receive a block of permanent site numbers to assign to the sites. Since that time, DLNR has assigned permanent numbers to the sites as part of their review of the project. Figure IV-6 illustrates the location and original numbers of the sites identified in the Chiniago survey. Figure IV-6a illustrates the location of sites by their new numbers. Table 4-10 lists the sites by old and new numbers and primary features present.

The historic Mamalahoa Trail, also known as the King's Highway, bisects the park site from north to south (Figure II-2). The trail is currently impassable in many

NELH

KEAHOLE AIRPORT

Wawaioli
Beach

QUEEN KAAHUMANU HIGHWAY

1"=1,200'



**Figure IV-6. HOST Park
Archeological Sites**
HAWAII OCEAN SCIENCE & TECHNOLOGY PARK
NATURAL ENERGY LABORATORY OF HAWAII
Keahole, North Kona, Hawaii

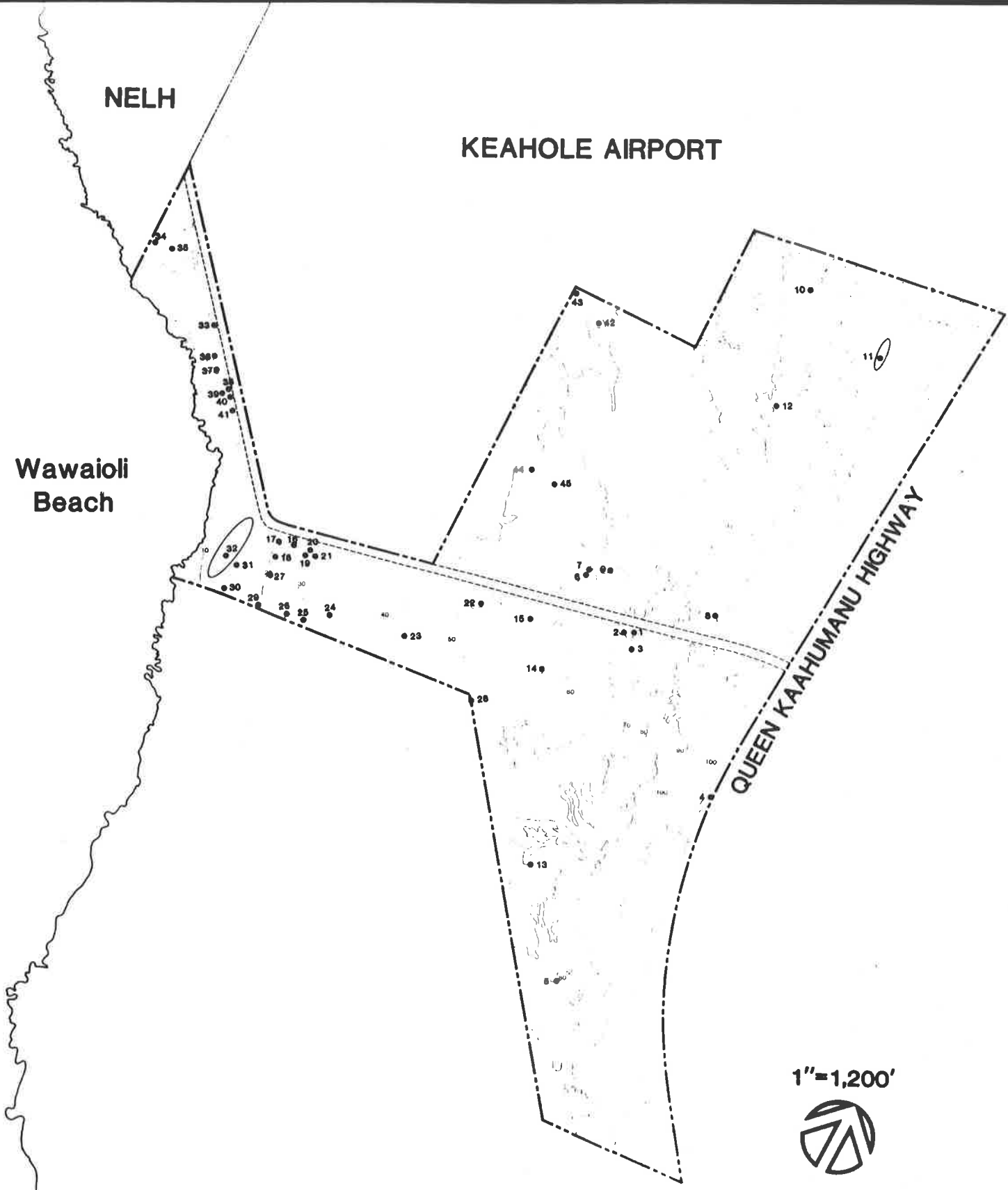

NELH

KEAHOLE AIRPORT

Wawaloli
Beach

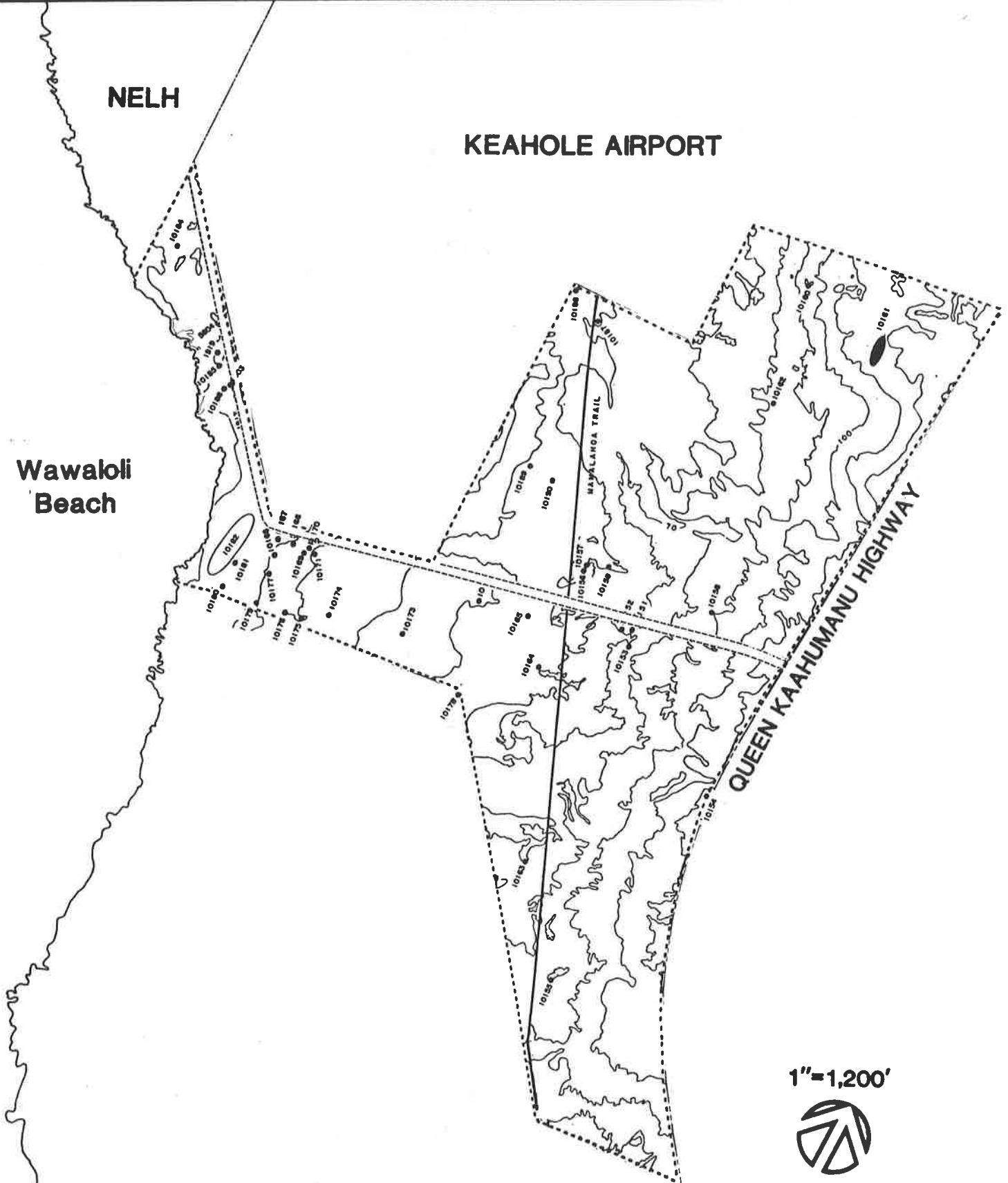

1"=1,200'



**Figure IV-6A. HOST Park
Archeological Sites
(Official Site Numbers).**
HAWAII OCEAN SCIENCE & TECHNOLOGY PARK
NATURAL ENERGY LABORATORY OF HAWAII
Keahole, North Kona, Hawaii

Table 4-10. Archaeological Sites at the
HOST Park Site

<u>Old Site #</u>	<u>New Site #</u>	<u>Description</u>
T-1	10151	Midden Scatter
T-2	10152	Stone Mound
T-3	10153	Stone Mound
T-4	10154	Walled Habitation
T-5	10155	Habitation Cave
T-6	10156	Stone Mound
T-7	10157	Stone Mound
T-8	10158	Clearing
T-9	10159	4 Habitation Shelters
T-10	10160	Stone Mound
T-11	10161	Mounds & Shelter
T-12	10162	Stone Mound
T-13	10163	Habitation Shelter
T-14	10164	Clearing
T-15	10165	Habitation Shelter
T-16	10166	Habitation Shelter
T-17	10167	Stone Mound
T-18	10168	Habitation Shelter
T-19	10169	Stone Mound
T-20	10170	Habitation Shelter
T-21	10171	Habitation Shelter
T-22	10172	Habitation Shelter
T-23	10173	Habitation Shelter
T-24	10174	Stone Mound
T-25	10175	Habitation Shelter
T-26	10176	Stone Mound
T-27	10177	4 Habitation Shelters
T-28	10178	Petroglyphs
T-29	10179	Habitation Shelter
T-30	10180	Habitation Shelter
T-31	10181	2 Stone Mounds
T-32	10182	Various Features
T-33	5604	Shelter & 2 Mounds
T-35	10184	Lava Bubble
T-36	1919	Habitation Shelter
T-37	10185	Midden Scatter
T-38	5603	Habitation Shelter
T-39	10186	Stone Mound
T-40	1917	Shelter, Wall & Cave
T-41	1917	Habitation Shelter
T-42	10187	4 Stone Mounds
T-43	10188	2 Stone Mounds
T-44	10189	Stone Mound
T-45	10190	Habitation Shelter
	2	Mamalahoia Trail

areas and has been completely obliterated, in some places, by the Keahole Airport runway.

A copy of the complete revised archaeological report is available for public review at HTDC, OEQC, UH Environmental Center and selected libraries.

1.2.2 NELH Site

An archaeological reconnaissance of the NELH property was conducted from August 6 through August 10, 1984 by the Department of Anthropology, Bernice P. Bishop Museum, under contract to the Marine Sciences Group, Department of Paleontology, University of California, Berkeley. The purpose of the survey was to determine the presence or absence and general nature of surface archaeological remains with the project area.

Twenty-four sites were recorded during the survey (Figure IV-7). Bishop Museum reports that the majority of sites are concentrated along the coast, near brackish-water pools. The sites are composed of more than 60 individual features and include 8 platforms, 14 enclosures, 2 historic house sites, 4 trails, 5 ahu (cairns), 2 papamu, 5 brackish (anchialine) pools, 5 cave shelters, 9 rock-filled crevices, 1 petroglyph area, 2 C-shape shelters, 4 walls, and numerous rock alignments. Table 4-11 lists the sites by number and primary features present. The surface remains were reported to be in only fair condition and have been subjected to a number of destructive forces. The museum believes that site deterioration is caused primarily by natural forces, including high surf and winds, and vandalism. Sites located near the shoreline (and thus exposed to high surf) are in worse structural condition than coastal sites situated further inland. Bishop Museum's complete report is available for public review at HTDC, OEQC, UH Environmental Center and selected libraries.

1.3 Site Significance

The sites in the area are primarily significant for the information they contain on the prehistory and early history of the area. Despite looting, much information is still present in the sites. Architectural remains still stand, and archaeological excavations have shown that deposits with important information do exist in some sites.

1.4 Impact Producing Actions

The following actions, to be undertaken during the development and operation of the project areas, may directly or indirectly impact the archaeological sites in the area:

- o Road grading and underground utility placement;
- o Construction and placement of up to 10 pipes and associated pumping systems in the coastal area;
- o Construction of seawater return flow disposal areas;
- o Subdivision of parcels and construction of improvements on them;

1"=1,200'



**Figure IV-7. NELH
Archeological Sites**
HAWAII OCEAN SCIENCE & TECHNOLOGY PARK
NATURAL ENERGY LABORATORY OF HAWAII
Keahole, North Kona, Hawaii

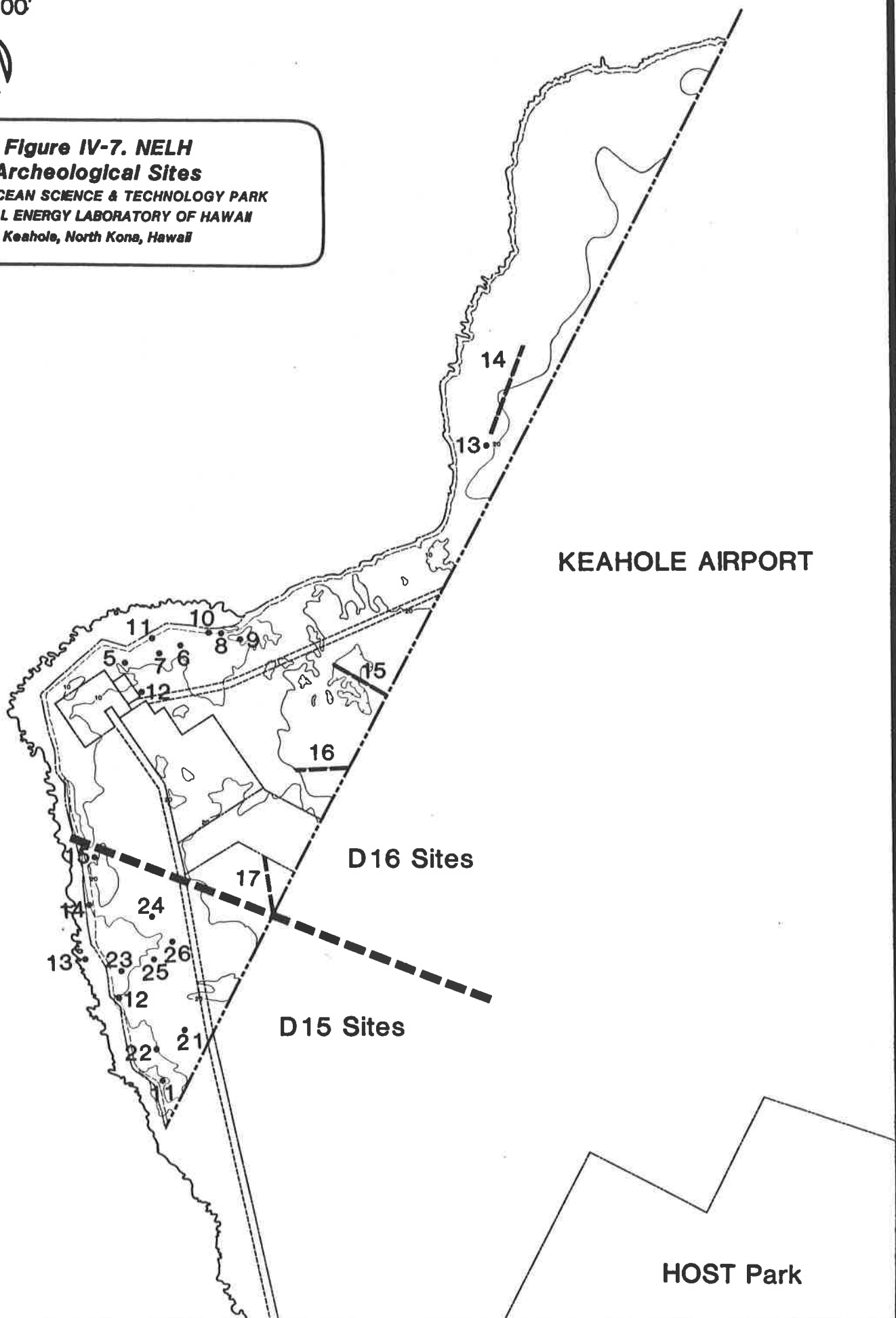

Table 4-11 -- Archaeological Sites at the
Natural Energy Laboratory of Hawaii Site
Keahole, Hawaii

Bishop Museum Site Numbers	Primary Features Present
D15-11(-1 to -3b)	Four enclosures.
D15-12(-1 to -4)	Enclosure, wall, two platforms.
D15-13	Platform.
D15-14(-1 to -3)	Platform, two enclosures.
D15-15(-1 to -10)	Two enclosures, platform, rock pile, two cave shelters, two <u>ahu</u> , petroglyph area, two walls, and two brackish pools.
D15-21*	Eight rock-filled crevices.
D15-22*	Rock-filled crevice.
D15-23(-1, -2)*	Platform, enclosure.
D15-24(-1, -2)*	Modified shelter cave, C-shape.
D15-25(-1, -2)	Shelter cave, platform.
D15-26*	<u>Ahu</u> .
D16-5	Enclosure.
D16-6(-1, -2)	Platform and historic house site.
D16-7	Enclosure, two platforms.
D16-8	Historic house site.
D16-9(-1, -2)	Enclosure, C-shape shelter, two brackish pools.
D16-10	Enclosure.
D16-11	Enclosure.
D16-12(-1, -2)*	Enclosure, wall.
D16-13(-1, -2)*	Cave shelter, <u>ahu</u> .
D16-14*	' <u>Opihi</u> -shell trail.
D16-15*	' <u>Opihi</u> -shell trail.
D16-16*	Basalt stepping stone and coral.
D16-17*	' <u>Opihi</u> -shell trail.

*Museum site number assigned at completion of this survey. Remainder assigned by Cordy (1978).

Source: Department of Anthropology, Bernice Pauahi Bishop Museum, An Archaeological Reconnaissance of Natural Energy Laboratory Hawaii (NELH) Property, Keahole Point, North Kona, Hawai'i. October 1984.

- o Increased activity on the sites, including up to 3,190 employees; and,
- o Increased public access to the shoreline areas.

These impacts may destroy or damage historic sites, and they might inadvertently increase looting through increased public access.

1.5 Potential Impacts and Mitigating Measures

Following the State Historic Preservation Office's recommendations, mitigation will focus on (1) preservation of excellent examples of different site types in the HOST and NELH areas, and (2) on archaeological data recovery at sites where significant information is still unrecorded and/or unrecovered. All the sites meriting preservation and data recovery will be placed in protected "no build" zones until preservation or archaeological data recovery is concluded. Based on the Historic Preservation Office's comments, a number of sites in the HOST and NELH areas have already had their significant information recorded and/or recovered, and these need no further consideration.

A historic preservation management plan is being prepared to include the details for preservation methods and the details for methods and interpretations needed in the archaeological data recovery work. This plan is to be reviewed and approved by the State Historic Preservation Office before any preservation and data recovery work occur.

The State Historic Preservation Office recommended the preservation of one site (the Mamalahoa Trail) and four examples of other site types (a historic period permanent dwelling site, a prehistoric period permanent dwelling site, a cave used as a prehistoric period temporary-use shelter, and a C-shaped enclosure also used as a shelter). These are sites that serve as examples of Hawaiian adaptation to the environment. They proposed that HOST and NELH jointly select one excellent example of each type from either parcel for preservation. Among the sites which have been selected, subject to concurrence by the State Historic Preservation Office, are:

- o The Mamalahoa Trail in the HOST Park.
- o D16-5 through D16-11, a set of historic period permanent dwelling sites, in the NELH area.
- o Site 1919, a prehistoric period permanent dwelling site, in the HOST Park.
- o Site 1917, a cave shelter in the HOST Park area.
- o One C-shaped shelter, in the HOST Park area. (Selected from sites 10159, 10161, 10163, 10172, 10173, or 10190)

Detailed preservation approaches will be presented in the management plan and will be reviewed and approved by the State Historic Preservation Office.

The State Historic Preservation Office recommended archaeological data recovery at all sites still containing unrecorded or unrecovered significant information. This work is feasible given the small size of the sites and their shallow deposits, and is

desirable given the possibility of increased looting and development. Table 4-11 lists the sites needing data recovery work in the HOST and NELH parcels. The needed work includes detailed mapping and excavation at those sites with deposits. The management plan will specify the minimum field and lab methods needed and the minimum interpretive analyses needed. Interpretations will include site-specific dating and functional interpretations and a general reassessment of the history of this area's land units (the Kalaoa and O Oma ahupua'a) based on the site findings. The management plan and its scope of work for data recovery is to be approved by the State Historic Preservation Office before any data recovery work is conducted. The State Historic Preservation Office will also evaluate the archaeological fieldwork for adequacy and provide a statement of adequacy before construction can proceed, and the Office will evaluate the archaeological final report to ensure lab and interpretive analyses have been adequately covered. Only after this report is accepted by the State Historic Preservation Office as adequate will the archaeological data recovery work be complete. (Note: The archaeological data recovery work may well proceed in increments in conjunction with development phases. The State Historic Preservation Office has indicated that this approach is acceptable and that adequacy review can be by increments.)

2.0 Recreational Resources

2.1 The Project Area

2.1.1 Existing Conditions

The Keahole region is one of the most important in the state for sport diving, as well as for commercial collecting of aquarium fish. In addition, the best board surfing site in the district of Kona is located nearby. The four miles of rocky shoreline from Kaloko to Keahole Point are backed by a long, sandy reach of storm beach that is frequented by beachcombers, campers, fishermen, sunbathers, picnickers, surfers, and scuba divers. The two most popular sites on this beach are "Pine Trees" and Wawaloli Beach.

The Keahole Point region is of high value for shoreline and ocean recreation on both a regional and island-wide scale. Although the entire area is undeveloped except for the NEHL facility, it receives high use as a wilderness beach park. In the entire district of Kona, which begins at Manuka to the south and extends to Anaehoomalu in the north, there is only one public beach park where camping is permitted--remote Milolii Beach Park. The proximity and security (the NEHL access road is locked from 8:00 p.m. to 6:00 a.m.) of the Keahole shoreline have made it a highly desirable site. In addition to camping, the area offers many excellent opportunities for a variety of ocean recreation, including one of the best surfing sites and one of the best scuba diving sites in the Kona district.

The four-and-one-half miles of rocky shoreline from Keahole Point to Mahaiula consist of low sea cliffs, some of them veneered by storm beaches of black sand. Makolea Beach is the only beach along this reach where the sand meets the ocean. This area is less accessible than the area immediately south of Keahole Point and it attracts primarily pole fishermen with four-wheel drive vehicles.

Discussion of recreational activities by location along the coastal areas of the project site are presented in Appendix F.

2.1.2 Impacts and Mitigating Measures

Siting of corridors and associated construction activities for up to 16 additional cold water and warm water intake pipes and associated pumps; improved access to the coastal areas of the project; construction of a restroom and paved parking in the coastal area; on-site presence of from 1590 to 3580 employees; an unknown number of additional visitors attracted to the project area; and project-induced regional population growth of between 3,560 and 8,400 people may impact the recreation areas adjacent to the project site.

The Keahole region is one of the most important in the state for sport diving, as well as for commercial collecting of aquarium fish. In addition, the best board surfing site on the island of Hawaii is located nearby. Pipelines through valuable sites would be detrimental.

The Keahole Point region is the most important wilderness ocean recreation area in the district of Kona. Despite the need for four-wheel drive vehicles to gain access to much of the coast, the shoreline is heavily used. If the NEHL-HOST facility accomplishes its purpose on a large scale, it could become a major employment center in the Kona district. If this occurs, employees can be expected to become regular users of the Keahole shoreline, and the wilderness quality of this shoreline will inevitably be reduced.

A visitor center is planned for the NEHL-HOST facility. This should be sited within the developed portion of the property and should not be sited near the shoreline. A shoreline visitor center would only increase vehicular and pedestrian traffic along a section of an important wilderness ocean recreation area that is already heavily used.

Although there is no question that the shoreline areas of the properties should be left open for public use, recommendations to improve physical access to the shoreline below the NEHL-HOST site are problematic. On the one-hand, plans for preserving and facilitating beach access at NELH and HOST Park form a significant component of the project from the perspective of community values; on the other-hand, access improvements could lead to overuse and congestion. This would reduce the quality of the ocean recreation which is so attractive to present users. Future planning for HOST Park will involve close coordination with the County of Hawaii in order to reach a mutually acceptable solution that will address the concerns of both the present users and the community as a whole.

Public activities at the shoreline may have to be monitored and controlled in the future in order to insure that public access and use is consistent with conservation of the existing natural resources. Of particular concern is the practice of driving on the sand (which disturbs strand vegetation), littering and vandalism of historic sites. Provision of the paved parking area will enable controls to be placed on where vehicles are allowed; if vehicles are restricted to existing trails and parking areas, potential damage to the beach ecosystem can be mitigated. It is also proposed that trash receptacles be placed in convenient places to minimize littering. Mitigation of archaeological sites by retrieving important information will serve to lessen the impact of vandalism. In the future, a management plan with enforcement provisions may have to be developed to preserve the shoreline resources.

2.2 The Region

2.2.1 Existing Conditions

Existing recreational facilities in North and South Kona and South Kohala include beach parks, historic sites, gyms, neighborhood parks, golf courses, tennis courts, and boat ramps, as well as other facilities. Sandy beach parks are limited on the Big Island, and several West Hawaii beach parks (particularly those in South Kohala) are important resources for East Hawaii residents as well.

In North Kona, there are nine county facilities totaling 34 acres and two state parks totaling 32 developed acres (plus 100 undeveloped acres at the Old Kona Airport park). The state also provides school playgrounds and boat ramps and harbors, and the largest public recreational facility near the project site is the state's Honokohau Boat Harbor and Ramp. The U.S. National Park Service has authorization to create a 1,300-acre "Kaloko-Honokohau National Historical Park," but no land has yet been acquired. In terms of beach parks, the major public facility is the state park at the Old Kona Airport. There are no public gymnasium facilities; most Big Island recreational halls were originally constructed by plantations, and North Kona's limited plantation heritage led to no such facility.

In South Kona, there are nine county parks totaling 18 acres; the state's 154-acre Kealahou Bay marine park (of which only two land acres have been developed), plus state playground and boat ramp facilities; and the 180-acre Puuhonua O Honaunau ("City of Refuge") visitor-oriented National Park. Major facilities include county beach parks at Napoopoo and Hookena and the state underwater park at Kealahou.

In South Kohala, public recreational facilities tend to be concentrated either in Waimea or along the coast. The county operates three facilities totaling 23 acres; the state has the 300-acre Hapuna Beach Park (with only 26 developed acres), plus a gymnasium for county recreational programs, the Kawaihae Boat Harbor, and Puako boat launch ramp; and the National Park Service administers the 35-acre Puukohola National Historic Site. The state's Hapuna Beach Park one of the island's most popular beach and camping areas.

2.2.2 Potential Impacts and Mitigating Measures

Project-induced population growth in the West Hawaii Region of approximately 3,560 people (Scenario A); 5,700 people (Scenario B); or, 8,400 people (Scenario C) may impact the recreation resources of the region.

The County of Hawaii Recreation Plan (Hawaii County Department of Parks and Recreation, 1973) recommends a standard of five acres per 1,000 resident population for Group 1 (neighborhood and community) parks and 10 acres per 1,000 residents for Group 2 (beach parks or other regional-type) facilities. The estimated population growth under Scenario A would thus generate a total need for 25 Group 1 park acres (including 18 acres in West Hawaii) and 50 Group 2 park areas (including 36 acres in West Hawaii). Under Scenario B, the additional population would require 41 Group 1 park acres (including 29 acres in West Hawaii) and 81 Group 2 park acres (including 57 acres in West Hawaii). Under Scenario C, the

need would be for 60 Group 1 park acres (including 42 acres in West Hawaii) and 119 Group 2 park acres (including 84 acres in West Hawaii).

Land for Group 1 parks would be provided to the county by future residential developers under the terms of the county's park dedication ordinance, which is based on the recommended standard of five acres per 1,000 residents. Land for Group 2 parks will be more difficult to acquire, especially in the case of expensive coastal property for beach parks. However, both state and county agencies have established plans and priorities for future park development or expansion, based on availability of public funding. Also, there is substantial undeveloped acreage adjacent to most of the state facilities.

3.0 Lifestyles, Values, and Social Cohesion

3.1 Existing Conditions

3.1.1 Lifestyles

The Kona Coast historically has been populated by independent and individualistic people. The "City of Refuge" National Park was the site of one of several havens for breakers of ancient Hawaiian kapu's. In the late 19th and early 20th centuries, Kona was again a refuge, this time for independent-minded people fleeing plantation labor contracts elsewhere on the island. The small family-farm operators continued this tradition of rugged individualism through the first half of the 20th century. Kona fishermen also have a reputation for independence.

South Kohala, by contrast, was historically a much more close-knit community, following the establishment of the Parker Ranch in the 1800's. In the manner of the times, ranch managers exercised extensive paternalistic control over most aspects of their employees' lives, including the provision of housing and health care.

In recent decades, the transition from an agricultural to a service-based economy -- accompanied by substantial in-migration and demographic shifts -- has modified these traditional patterns. South Kohala's social fabric has become more diverse and permissive, while Kona residents now are more likely to belong to some common social or economic institution (e.g., labor unions at major hotels).

As the district experiencing the earliest change and greatest mainland in-migration, North Kona underwent perhaps the most difficult transition time during the 1960s and early 1970s. Government agency personnel interviewed for this report say that past social conflicts have diminished in recent years. Various community segments have been brought together, in part, by a common effort to obtain more government services and a greater recognition by state and county decision makers of West Hawaii's potential for economic growth.

West Hawaii residents today appear to differ markedly from East Hawaii people in political and other value orientations. Kona (and, to some extent, Kohala) residents reflected different views and attitudes in responses to a recent county-sponsored "Survey of Big Island Residents on Planning and Housing Concerns" (Hawaii Opinion, 1983):

- o West Hawaii respondents were more likely than other Big Island residents to emphasize their love of good weather as the "best" thing about Hawaii life, and they were more likely to talk about the high cost of living or of housing when asked about negative features. These had also emerged as the most important points in a 1980 Kona survey conducted for the Kona Regional Plan (Hawaii County Department of Planning, 1982).
- o More than other Big Island residents, they expressed strong dissatisfaction with local government, traffic congestion, and quality of schools.
- o In particular contrast to Hilo-area residents, West Hawaii respondents rejected government subsidies for new industry or tax hikes as mechanisms to encourage either economic development or provision of better services.

3.1.2 Attitudes and Values

To date, no formal survey research has been conducted on community attitudes toward the proposed HOST Park or NELH expansion. However, the county's 1983 planning survey (Hawaii Opinion, 1983) indirectly measured attitudes toward various industries. Results -- summarized in Table 4-12 -- suggest strong support for aquaculture, both islandwide and in Kona. There was less apparent enthusiasm for research activities, possibly reflecting the chosen example of Mauna Kea observatories.

More broadly, recent surveys indicate that Big Island residents' major priority for government is to stimulate economic development. In the most recent Hawaii State Plan Survey, "Getting more jobs and industry for Hawaii" was ranked "extremely important" by 67 percent of the Big Island sample -- a higher percentage than either: (a) was found in any other county in this statewide poll; or (b) than Big Island residents gave to any other suggested government activity (e.g., cutting down on crime or improving education) (SMS Research, 1984, pp.8-18). In the county's survey, 68 percent of the islandwide sample, and 61 percent in Kona, said the Big Island's economy "is in bad shape" (Hawaii Opinion, 1983, p.8). Despite this emphasis on development, 67 percent of the islandwide sample, and 77 percent in Kona, would not approve any economic development which restricted public access to a recreational area (ibid., p. 9).

3.1.3 Social Cohesion/Crime

As shown in Table 4-13, Kona's rate of serious recorded crime during the early 1980s has consistently been 25 to 30 percent greater than the islandwide rate. It has sometimes exceeded and sometimes fallen below the islandwide rate for serious recorded crime. As in Kona, its 1970 crime rate exceeded the islandwide rate by proportionately more than has been the case more recently. In the early 1980s, South Kohala police have usually logged a particularly high (relative to population) number of complaints about larcenies and vandalism. The area's beachparks, which are islandwide recreational attractions, generate many of these problems.

Kona's relatively "fast-paced" lifestyle shows up in other police data. With only about 23 percent of Hawaii County's total resident population (and less than 30 percent of de facto population, including visitors), the combined North and South

Table 4-12 -- Community Priorities on
New Industries for Big Island Development

Survey Question: "If you had ten million dollars to help industries on the Big Island, how would you use the money? That is, which industries would you put money into and how would you divide it up?"

	percentage of dollars per		respondent	
	respondents		(avgd. over all	
	willing to assist this industry		respondents in this area)	
	island	Kona	island	Kona
	(%)	(%)	(millions of dollars)	
diversified agriculture	75%	75%	\$1.97	\$2.12
tourism	73%	71%	\$1.71	\$1.89
aquaculture/fishing	65%	67%	\$1.35	\$1.51
construction	53%	43%	\$1.14	\$0.93
sugar	49%	35%	\$1.29	\$0.70
geothermal related	41%	51%	\$0.78	\$1.10
research activities (e.g., Mauna Kea observatories)	39%	40%	\$0.64	\$0.72
heavy industry (e.g., manganese nodules)	25%	21%	\$0.43	\$0.41
other industries	4%	3%	\$0.13	\$0.07
no industry indicated	10%	11%	\$0.61	\$0.57

base: Kona -- 338; island -- 1055

note: Percentages may exceed 100% because of multiple responses.

Table 4-13 -- Rates of Recorded Serious Crime for County and West Hawaii

	1970 =====	1980 =====	1981 =====	1982 =====	1983 =====
County =====					
Recorded Part I Crimes*	2,046	6,078	6,377	6,375	5,652
Population **	63,468	93,047	97,012	100,130	102,880
Rate/10,000 Population	322.4	653.2	657.3	636.7	549.4
Kona (North and South) =====					
Recorded Part I Crimes*	478	1,616	1,797	1,850	1,653
Population **	8,836	19,922	20,999	22,133	23,329
Rate/10,000 Population	541.0	811.2	855.8	835.9	708.6
South Kohala =====					
Recorded Part I Crimes*	127	339	283	337	247
Population **	2,310	4,664	4,898	5,144	5,402
Rate/10,000 Population	549.8	726.8	577.8	655.1	460.9

Notes: * "Part I" crimes include more serious offenses -- e.g., murder, rape, robbery, assault, burglary, larceny, auto theft.

** 1970 population is U.S. Census figure for April 1. 1980 - 1983 population figures are for July 1 of each year and were estimated by Community Resources, Inc. based on growth rate from April 1, 1980 U.S. Census figure to Hawaii State Department of Planning and Economic Development (1985b) estimate of district populations for January 1, 1983.

Source: Computed by Community Resources, Inc., 1985, based on data from Hawaii County Police Department Annual Reports (1971, 1981, 1982, 1983, and 1984).

Kona police district logged 51 percent of all recorded speeding traffic violations in 1983 (Hawaii County Police Department, 1984). South Kohala also had a slightly disproportionate number of recorded hazardous traffic violations.

3.2 Impacts and Mitigating Measures

Three socioeconomic and/or demographic factors associated with this project have the potential for social impact. In order of increasing importance, they are:

- o Projected project-related population increases in the West Hawaii area of 3,560 under Scenario A, 5,740 under Scenario B, and 8,400 under Scenario C.
- o Potential increased in-migration from outside of Hawaii.
- o Possible industry-related hiring practices (based on required skills).

Impacts associated with the potential continuation of West Hawaii's rapid population increase:

Dissatisfaction with Kona's high growth rate of the 1970s was apparent in the surveys conducted for the Kona Regional Plan (Hawaii County Planning Department, 1982) and for the county's islandwide planning efforts (Hawaii Opinion, 1983). Rapid growth is disorienting to both psychological and social stability, and it taxes public facilities and services. However, it is not actually known whether the NELH/HOST Park project will develop at slow or rapid pace.

The most problematic form of growth is that which comes in major periodic spurts, as with the opening of large new factories or hotels. Since the Keahole project will involve a number of relatively small enterprises starting up business gradually and one at a time, it is unlikely to stimulate "boomtown" problems itself.

Impacts associated with increased in-migration from outside Hawaii:

If a significant number of Asian firms move into NELH or HOST Park and choose to import many higher-level workers, this could bring a need for cultural adjustments on both sides. At the moment, it seems more likely that in-migrants would come from the Mainland (either upper-level personnel making an initial move or younger persons already in Kona who see the chance to remain because of direct or indirect employment). The social impact here would involve intensification of existing trends toward a more "mainland lifestyle" and value orientation.

Impacts associated with industry-related hiring practices:

A frequent criticism of the visitor industry is that outsiders end up in top management while local residents dominate the less desirable positions. High-tech industries will also feature a spectrum of jobs, with the lower-level ones involving very limited pay and monotonous tasks. Since upper-level jobs will require specialized education and advanced degrees, the initial staffing pattern may well tend to outsiders on top, locals on the bottom. This is unlikely to cause immediate problems because of the present demand for jobs of virtually any nature, but it has the long-term potential for resentment and alienation. (It should also be noted that virtually any new industry with the capacity to provide substantial employment

would present the same problems, since few local residents seek training for higher-level jobs until they know those jobs actually exist.)

For most of the potential negative impacts which have been mentioned, the best mitigation would be a training and education program to maximize local employment benefits at all job levels. It would be important for such a program to attend to all segments of the longtime resident community.

A final set of potential social impacts involve particularly abstract and intangible psychological considerations. One is the potential for increased community pride if the NELH/HOST Park project makes Hawaii a world leader in ocean-based science and technology. Related to this could be a sense of satisfaction that West Hawaii has proved its potential for economic development in fields other than tourism, thereby earning even more respect and recognition from the remainder of the island and state. Such successful economic diversification could also bring a measure of security through the knowledge that the area has grown less dependent on the sole and relatively fragile industry of tourism.

H. THE NO PROJECT ALTERNATIVE

1.0 HOST Park

Under the no project alternative, the 547 acres of state land would remain vacant, at least temporarily, until some other economic use is proposed. Any alternative use would probably also be industrial in nature because of the close proximity to the airport. Low or moderate income housing, for example, would not be suitable because of noise and building restrictions. The area does not have unique features that would make it desirable for a recreational park, except perhaps in the coastal areas. The coastal areas will be maintained for public use.

Alternative industrial uses would not utilize the unique resources of the site, such as the nearshore deep cold water. In addition, development of a traditional industrial park would put the state in competition with private developments and unnecessarily commit state resources to a project that the private sector is able and probably more capable of developing.

If nothing is developed on the site, the vistas to the ocean will be uninterrupted and undisturbed. Employment opportunities for Big Island residents will not be created, but on the other hand, the housing situation would not be exacerbated. The potential disruption of the aquifer and future change in the anchialine ponds would not occur, and the marine environment would not be disturbed, unless NELH expands as planned.

Under the no-project alternative, the state would lose the opportunity to develop its "high-tech" niche in ocean-related industries. It will slow down the process of economic diversification for the West Hawaii Region, now dependent almost entirely on tourism. Mariculture and energy projects being developed at NELH would probably leave the state when expansion is required for full-scale commercialization of the activity. Both the State and the County of Hawaii may lose their chance to become world leaders in ocean-based science and technology.

2.0 NELH

Under the no-project alternative for NELH, the Department of Energy (DOE) would provide no more funding to the facility. The 30-inch DOE pipe would not be built and the expanded closed- and open-cycle OTEC, desalination and SPOTEC projects would not take place.

There would be no further expansion of either energy or mariculture activities. The State of Hawaii would lose federal funds and other research funding.

The site is located near the airport and on low-lying ground. Its current use is probably the most suitable for the site. As DOE funding stops, and no further mariculture or other research and/or production takes place, the facility would probably be left with a minimal operation that could be supported by the state. There would be no expansion of mariculture and other projects. This would also affect the success of HOST Park. In addition, the state would lose its alternative energy showcase.

I. PROBABLE ADVERSE ENVIRONMENTAL EFFECTS WHICH CANNOT BE AVOIDED

1.0 Construction Impacts

1.1 Traffic:

There will be an unavoidable increase in traffic during the construction period in order to bring construction equipment and materials to the site. This impact will be intermittent but it will continue for some time into the future as various projects come on-line.

1.2 Air Quality:

Increased traffic and the use of heavy construction equipment will lead to the temporary generation of emissions from internal combustion engines. Construction activities will lead to increased dust and particulate matter in the air. These impacts will be mitigated by adhering to existing governmental air quality regulations.

1.3 Vegetation:

Construction of the on-land portions of the ocean water supply pipes and associated pumps may destroy some strand vegetation. The area will be replanted immediately to stabilize the beach sand.

1.4 Terrestrial Fauna:

Resident fauna in the areas directly disturbed by construction may be destroyed. Other fauna inhabiting the site may be temporarily frightened away. The area has a low concentration of wildlife because of its sparse vegetation. There are no known officially designated endangered or threatened terrestrial species that inhabit the project site. Some invertebrate species inhabiting areas directly affected by construction will not survive.

Noise from blasting, drilling and other construction activities will probably disturb resident wildlife. There are no terrestrial endangered or threatened species in the project area; the area is adjacent to the airport and thus subject to intermittent noise from aircraft take-offs and landings.

1.5 Marine Fauna:

If trenching is required offshore, it will displace or destroy benthic organisms in the line of the trench. Some damage could also occur to coral beds during the placement of offshore pipelines. Noise and shock waves produced by drilling and blasting in the nearshore waters may produce behavioral modifications among motile organisms. Because the endangered humpback whale and threatened green turtle could be affected, blasting will be prohibited when the whales are present and visual surveys of the area will be taken prior to this activity to insure that turtles are not present. Additional specific mitigating measures will be developed in coordination with the National Marine Fisheries Services.

1.6 Water Quality:

The dense basalts offshore will generate relatively little silt during construction operations. Some temporary turbidity will result but will be quickly dispersed by the ocean currents.

1.7 Noise:

Noise may also disturb personnel who are working at either the NELH or HOST sites.

1.8 Archaeological Sites:

Archaeological sites directly affected by construction activities will be destroyed. Information will be retrieved prior to destruction as recommended by the State Historic Preservation Officer.

1.9 Recreation Activities:

Some disruption of beach recreation can be expected during the construction period due to concerns for public safety.

2.0 Operations

2.1 Traffic:

Increased traffic will result from increased employment on the site. The situation will be monitored carefully and additional intersection improvements and/or access points will be provided to minimize congestion on Queen Kaahumanu Highway.

2.2 Seawater Return Disposal:

The on-land disposal of ocean water could disrupt and displace the existing brackish water lens for some distance inland and along the coast. The aquifer is not developable; however, it does supply the water for some stands of kiawe trees located north of Keahole Point and in the vicinity of Wawaloli Beach. These trees would probably not survive the change in salinity caused by the ocean water plume.

As disposal continues, the anchialine ponds on the project site may slowly lose their brackish character; in about 10 to 20 years the ponds located in the vicinity of Wawahiwa Point, approximately 1.5 miles south of the project site, could also be affected. This effect can be mitigated, if desired, by creating new ponds by digging pits to intersect the water table at nearshore locations out of the zone of impact of the seawater return flow.

The seawater return flows may be cooler than ambient water temperature of the receiving waters. This could have detrimental effects on the coral community. Corals are very temperature sensitive, and if the seawater return flows consist solely of cold water, corals could be killed for some distance along the coast, depending upon the plume advection. This can be mitigated by warming the water before it is disposed of in the seawater disposal trenches.

Preservation of the integrity of the source waters is critical to the success of both NELH and the HOST Park. An intensive on the other-hand, access improvements could lead to overuse and congestion. This would reduce the quality of the ocean recreation which is so attractive to present users. Future planning for HOST Park will involve close coordination with the County of Hawaii in order to reach a mutually acceptable solution that will address the concerns of both the present users and the community as a whole.

Public activities at the shoreline may have to be monitored and controlled in the future in order to inson the aquifer and it will revert back to its original condition in a short time.

2.3 Intake Pipes

The presence and operation of 10 to 15 additional intake pipes (both cold water and warm water) could have some adverse effects on the environment. Operation could result in impingement and entrainment of organisms. Little effect is expected from the cold water intake pipes placed at a depth of 2,000 feet; the operation of the warm water intake pipes in shallower waters could affect larval fish. This would only be a factor on warm water intakes placed where larval fish are concentrated. At present, there is no conclusive evidence of actual declines in any fishery due to impingement or entrainment losses.

The physical presence of the pipes and pumps is not expected to affect public access or recreation activities to a significant degree. It is expected that the pipes will be buried for some distance offshore and up to several hundred feet inland. Archaeological sites which may be affected will be mitigated before the pipes are laid.

2.4 Access and Recreation Resources:

Increased public access resulting from operation of HOST Park could have some detrimental effects on the beach recreation areas; it could lead to overuse and congestion. Other potential problems are the increased chance of vandalism, and problems with litter and beach maintenance. Driving along the beach destroys strand vegetation; if not protected by the vegetation, the sand may disappear. An enforceable management-monitoring program may have to be developed in the future in order to insure that the beach areas are not irretrievably destroyed by indiscriminate use.

2.5 Housing:

Increased employment may impact the West Hawaii housing prices and supply. Unlike resort development, where the number of potential employees is known prior to construction and where the employees all come "on-board" at the same time, the contribution of the HOST and NELH projects is expected to be comparatively modest since expansion is expected to be relatively gradual. Some workers will encounter problems of housing affordability and mitigating measures are being developed in coordination with the State of Hawaii Housing Authority and the County of Hawaii Department of Housing and Community Development.

2.6 Visual Impact:

The appearance of the inland areas of the HOST Park site will change, as is always the case when barren land is developed. Because of FAA regulations regarding construction near airports, all structures will be lowrise. Large lots will provide extensive areas of open space. Every effort will be made to preserve ocean views. Nevertheless, the presence of header tanks, pipes, ponds, raceways, buildings and parking areas on a formerly undeveloped site may be considered a negative impact to some people.

J. THE RELATIONSHIP BETWEEN LOCAL SHORT TERM USES OF MAN'S ENVIRONMENT AND THE MAINTENANCE AND ENHANCEMENT OF LONG TERM PRODUCTIVITY

The proposed HOST Park and the expansion of NELH will be an important addition to Hawaii's growing research and development industry and to Hawaii's search for economic diversification and alternative energy resources. The commercial activities at HOST Park are expected to diminish West Hawaii's dependency on tourism for long term employment for residents. Expansion of NELH and development of HOST Park can enhance the image of the state and county as a world leader in ocean-based science and technology and facilitate establishment of the state's "hi-tech" niche.

The energy and mariculture research and development activities at NELH will encourage outside investment in commercial scale projects; knowledge gained will be disseminated throughout the scientific community and effects will be felt worldwide. As techniques for cold water mariculture are continually refined, new industries may develop which will utilize the techniques being developed in Hawaii and many will choose Hawaii as the location of their production facilities. This could further enhance the opportunities for economic diversification in the state.

The water-quality monitoring activities at NELH will enhance knowledge of coastal and ocean processes and facilitate the development of standards for mariculture and other ocean-related research and development activities throughout the state. This item is high priority because preservation of the integrity of the cold and warm ocean water resources is fundamental for the continued growth and success of the proposed projects. If the water is degraded, the projects will no longer have the unique resource necessary to attract the energy and mariculture activities important to their success.

The major tradeoffs will be the potential disruption and displacement of the existing brackish water aquifer resulting in some potential impacts to vegetation and anchialine ponds and the change in the character of the area by the presence of industrial activities on formerly open barren lava land. Some risk is also present to the offshore coral beds. More people may also be attracted to the beach areas fronting the project sites, resulting in overuse and potential damage to the strand vegetation. These impacts can be mitigated.

The development will result in a long-term (65 years) commitment of land for the uses described in the plans. Once developed, it is unlikely that the land will revert to open space in the future. The County of Hawaii has general planned both the HOST and NELH sites for industrial use and the proposed actions will only commit the sites to this use.

This environmental impact statement has been prepared to disclose the potential implications of proceeding with the proposed developments. It will be the responsibility of various state, federal and county officials to evaluate the tradeoffs between economic development potential and effects on the natural environment and to make informed decisions based on knowledge of the potential consequences. Mitigating measures, as outlined in this report, can be incorporated into the various permits required by these agencies.

K. IRREVERSIBLE AND IRRETRIEVABLE COMMITMENT OF RESOURCES

The construction and operation of the proposed projects will involve the irretrievable commitment of natural and fiscal resources. Major resource commitments include land, money, construction materials, manpower and energy. The impacts of using these resources should be weighed against the economic benefits to the residents of the state.

Land committed to the projects is adjacent to airport industrial activities and thus would be a continuation of an existing land use pattern. The capital committed in the construction of the projects will be irrevocably committed, although some may be recovered in the lease rents paid by future commercial tenants.

The commitment of resources required to accomplish the project includes labor and materials, which are mostly unrenowable and irretrievable. Benefits will accrue to the County of Hawaii construction industry. The operation of the project will create new jobs for West Hawaii residents but will also increase the consumption of potable water and petroleum-generated electricity which also represents the irretrievable commitment of resources.

If properly monitored, almost all of the potential negative environmental effects of the project on natural resources can be reversed and/or mitigated.

**PART V: THE RELATIONSHIP OF THE PROPOSED ACTION TO
LAND USE PLANS, POLICIES, AND CONTROLS FOR THE AFFECTED AREA**

A. STATE LAND USE LAW (Chapter 205 H.R.S., as amended)

The proposed HOST Park is situated within the State Land Use Conservation District. DPED, as representative of HTDC, has petitioned the Land Use Commission for a District Boundary Amendment to reclassify the property to Urban in order to allow development of HOST Park. The request is consistent with the Land Use Commission's standards used to establish Urban District Boundaries.

The lands of the HOST Park site are gently sloping, and no drainage channels are present. The site can be considered reasonably free from the danger of floods, tsunami and unstable soil conditions, except in the coastal areas. No development is planned for the coastal areas of the site, except for the possible installation of pipes and pumps. These structures will be designed to withstand adverse wave conditions.

The proposed HOST Park will be contiguous to the present Urban District and promotes compact urban development, taking advantage of the proximity of NELH and the Keahole Airport for operational and logistical support. The development will generate a new center of employment and HTDC will provide basic infrastructure when municipal services are not available.

The site is consistent with the Land Use Pattern Allocation Guide (LUPAG) Map of the Hawaii County General Plan. No General Plan Amendment will be required. The proposed activities and uses of HOST Park are included in the provisions of the Hawaii County Ordinances for industrial zoning. The property is presently zoned Open, however, it will be rezoned to industrial use (MG3a) if the Boundary Amendment is approved by the Land Use Commission.

The NELH site is in the Urban District.

B. THE HAWAII STATE PLAN

Both the proposed HOST Park and proposed expansion activities at NELH are in conformance with the Hawaii State Plan.

1.0 The Economy.

1.1 Goal for the Economy

Both HOST and NELH are supportive of efforts to achieve a strong, viable economy, characterized by stability, diversity and growth which enables the fulfillment of the needs and expectations of Hawaii's present and future generations.

1.2 Objectives and Policies for the Economy - In General

The proposed HOST Park and NELH expansion will provide for increased and diversified employment opportunities to achieve full employment, increased income and job choice, and improved living standards for Hawaii's people.

The projects will promote Hawaii as an attractive market for investment activities that benefit Hawaii's people.

The developments will support business expansion and development to achieve a stable and diversified economy. They will encourage the development of industries which promise long-term growth potentials and which have the following characteristics:

- o Industries that can take advantage of Hawaii's unique location and available manpower resources.
- o Clean industries that will have minimal effects on Hawaii's environment.
- o Industries willing to hire and train Hawaii's people to meet their labor needs; and,
- o Industries that would provide reasonable income and stable income.

1.3 Objectives and Policies for Increased Public and Private Investment in the Neighbor Islands.

The proposed developments will encourage major state investments to promote economic development and private investment to the neighbor islands, specifically the island of Hawaii.

1.4 Objectives and Policies for Directing Growth to Existing Urban Areas or to Lands Adjacent to Such Areas

Both NELH and HOST Park are located next to Keahole Airport and a few miles away from two industrial park complexes.

1.5 Objectives and Policies for the Economy - Potential Growth Activities

- o Both the proposed HOST Park and NELH meet the objectives of developing and expanding potential growth activities which serve to increase and diversify Hawaii's economic base. NELH's function as an incubator facility for energy and mariculture research and development, and the HOST Park's stated orientation toward the development and commercialization of ocean-related high technology products and services will serve to diversify the economic base of the island of Hawaii as well as the state.
- o The presence of HOST and NELH will encourage investment and employment in energy and marine-related industries. The facilities will also enhance Hawaii's role as a center for ocean technology and education.
- o The utilization of the resources unique to Keahole Point by HOST and NELH will serve to promote Hawaii's geographic, environmental and technological advantages to attract new economic activities to the state. The facilities will accelerate the research, development and commercialization of new products based on ocean resources.
- o The state's continuing support of NELH and its investment in the development of the proposed HOST Park will attract new industries to Hawaii that will support Hawaii's economic and environmental objectives. Both NELH and HOST Park will support the generation of new ocean-related economic activities in food production and scientific research which are cited in the Hawaii State Plan.

2.0 Energy Policies

The proposed developments are supportive of the following energy policies and objectives:

- o The activities at NELH and HOST will serve to accelerate research development and use of new energy sources.
- o The existing and planned activities at HOST and NELH are intended to promote the use of new energy sources, in particular the potential of internal use of OTEC power to supply a portion of the facilities power needs.

3.0 Priority Directions

The proposed developments are supportive of the following priority directions of the Hawaii State Plan:

- o The facilities will encourage the use of public and private resources to develop aquacultural activities which have economic growth potential.
- o NELH and HOST promote the development of industries that take advantage of Hawaii's unique location and available resources.
- o The facilities will enhance ongoing technological resources and development by providing an environment for product commercialization and industry development.

C. HAWAII COASTAL ZONE MANAGEMENT OBJECTIVES AND POLICIES

The relationship of the proposed projects to the objectives and policies of the Coastal Zone Management Program (HRS 205A-2) is discussed in the following subsections.

1.0 Recreational Resources

The entire length of the HOST Park and NELH shoreline will be retained for public use; a small paved parking area and restroom facility may be provided fronting the HOST park site. This facility will be open to the general public and to recreational users such as surfers, fishermen and beachcombers.

Public activities at the shoreline may have to be monitored and controlled in the future in order to insure that public access and use is consistent with conservation of the existing natural resources. Of particular concern is the practice of driving on the sand (which disturbs strand vegetation), littering and vandalism of historic sites. Restricting vehicles to existing jeep trails and designated parking is one means of minimizing potential damage to the beach ecosystem. It is also proposed that trash receptacles be placed in convenient places to minimize littering. Mitigation of archaeological sites by retrieving important information will serve to lessen the impact of vandalism. In the future, a management plan, with enforcement provisions, may have to be developed in order to insure the preservation of the shoreline resources.

The proposed uses comply with CZM policies for recreational resources by providing "adequate public access consistent with conservation of natural resources to and along shorelines with recreational value," "an adequate supply of ... other recreational facilities suitable for public recreation" and "encouraging expanded public recreational use of ... State ... controlled shoreline lands and waters having recreational value."

2.0 Historic Resources

Archaeological surveys were completed for both the NELH and HOST Park sites. This complies with the CZM policy requirement that the developer "identify and analyze significant archaeological resources." The sites in the area are primarily significant for the information they contain on the prehistory and early history of the area. Archaeological excavations have shown that deposits with important information do exist in some sites. A summary of the findings of these surveys appears in Part IV of this EIS.

Because it is probable that some historic/archaeological sites may be destroyed in the construction of HOST Park, archaeological mitigation has been incorporated into the scope of work for design and construction of the improvements. Mitigation measures will include:

- o Preservation of the Mamalahoa Trail;
- o Archaeological data recovery work (detailed mapping and, if required, controlled excavation) on all sites that will definitely be destroyed and others that are in close proximity to construction work and have the potential to be disturbed;

- o Coordination with the State Historic Preservation Officer to insure that important sites are preserved;
- o Designation of "no build" areas along the land portions of the ocean research corridor where no construction will be allowed unless appropriate archaeological mitigating measures have been undertaken; and,
- o Archaeological mitigation of all sites on NELH property that may be disturbed by development activities.

3.0 Scenic and Open Space Resources

The CZM objective relative to scenic and open space resources seeks to "protect, preserve, and, where desirable, restore or improve the quality of coastal scenic and open space resources." The NELH site is partially developed and the HOST Park site is characterized by a desert-like appearance with sparse, dry grasses and herbs providing the only color to the dark lava landscape. Both facilities will be visible from Queen Kaahumanu Highway. It is expected that visual impact will be minimized due to the anticipated low building profiles. Significant development constraints are imposed on the developments by the nearby Keahole Airport. Due to its proximity, both HOST and NELH and their respective tenants will be restricted from constructing any facilities or carrying on any operations which may jeopardize the safety of flight operations in and out of the airport (U.S. Department of Transportation, 1975). The proposed uses are therefore in line with the CZM policy which requires the developer to "insure that new developments are compatible with their visual environment by designing and locating such developments to minimize the alteration of natural landforms and existing public views to and along the shoreline."

In addition, the HOST Park will be set back from Queen Kaahumanu Highway a sufficient distance to minimize visual impacts from the road. Landscaping and a new entry feature or features will be provided at the NELH access road intersection. A landscaping plan is being prepared that will enhance the visual appearance of the area. Design criteria for all facilities will help to insure a consistent, attractively built environment. All utilities will be underground and, wherever possible, pipes and other ocean water-related infrastructure will be partially buried and painted to minimize adverse visual effects.

4.0 Coastal Ecosystems

The activities to be carried out by NELH and HOST Park are consistent with the CZM policy to "improve the technical basis for natural resource management." Both facilities rely on the availability of clean seawater for their success. The State Department of Health defines the nearshore waters as Class AA, therefore the disposal of seawater return flows must be accomplished in a responsible manner. This is necessary not only to insure compliance with State Water Quality Standards, but more importantly to maintain the high quality of the source water. The monitoring program which will be instituted in conjunction with the proposed on-land trench disposal system will improve the technical basis for natural resource management. Standards can be developed and applied to similar projects statewide.

The CZM objective relating to coastal ecosystems is to "protect valuable coastal ecosystems from disruption and minimize adverse impacts on all coastal ecosystems." The EIS has identified several potential negative effects on these systems that might result from on-land disposal of seawater return flows. Among these are: changes in the salinity of the anchialine ponds; possible destruction of kiawe trees on the site; future changes in off-site anchialine ponds; and potential damage to corals from the temperature difference between the seawater return flows and the ambient ocean water. Because of the incremental nature of the projects, alternative methods of disposal can be implemented if the results of the monitoring program indicate that these potential adverse impacts are greater than expected. The effects on the aquifer are completely reversible; if on-land disposal is terminated for any reason, the aquifer will return to its original state, as will any affected anchialine ponds or vegetation. In order to prevent destruction of coral, seawater return flows will be warmed before disposal.

While the installation of pipelines off the project area pose another potential threat to the existing ecosystem, the major impacts will be short-term during the construction period. Preservation of the unique ocean resources at Keahole will receive the highest priority and attention -- everything possible will be done to comply with policies to "preserve valuable coastal ecosystems of significant biological or economic importance" and "promote water quantity and quality planning and management practices which reflect the tolerance of . . . marine ecosystems and prohibit land and water uses which violate State water quality standards."

5.0 Economic Uses

The location of both the HOST Park and NELH sites is consistent with CZM policies relating to economic uses. CZM objectives relating to economic uses seek to: "concentrate in appropriate areas the location of coastal dependent development necessary to the State's economy; insure that coastal dependent development . . . is located, designed, and constructed to minimize adverse social, visual and environmental impacts in the coastal zone management area" and ". . . permit coastal dependent development outside of presently designated areas when . . . adverse environmental effects are minimized; and . . . is important to the State's economy."

Both projects are dependent upon the close proximity to deep, cold, nutrient-rich and pure ocean seawater available off of Keahole Point for their activities. OTEC and other energy projects at NELH would not be possible without this water. This unique water resource is also indispensable for the continuing development of high intensity mariculture and other ocean-related activities. The nearby availability of this resource (the ocean bottom drops off rapidly in the Keahole Point area, reaching depths of 2,000 feet or greater at distances less than a mile from shore), makes the location highly desirable for potential tenants. Because of the costs of construction and deployment of intake pipes, use of deep ocean water might not be economically feasible at any other location in the state.

6.0 Coastal Hazards

The CZM objective with regard to coastal hazards is to "reduce hazard to life and property from tsunami, storm waves, stream flooding, erosion, and subsidence." Tsunami and flood hazards are discussed in Part IV of this EIS and U.S. Army Corps

of Engineers flood insurance rate maps are presented. No development is proposed for the affected areas on the HOST Park site, with the possible exception of a restroom. Future construction at NELH will also respect these constraints. Pipes and pumps on both properties will be an exception and they will be constructed to withstand design wave forces.

Although no significant drainage impacts are anticipated due to the low amount of rainfall in the area, appropriate drainage improvements will be constructed on-site to insure that storm runoff does not affect the nearshore waters.

7.0 Managing Development

Both HTDC and NELH, in cooperation with DPED, have sought to "improve the development review process, communication, and public participation in the management of coastal resources." There has been great emphasis placed upon interagency coordination through the project review process. A public information meeting was held in Kailua-Kona on July 8, 1985. Additional public review will be afforded during the review process of this EIS.

D. CONSERVATION DISTRICT POLICIES AND REGULATIONS

The HOST Park property is currently in the State Land Use Conservation District. Conservation (as defined in Subchapter 1 of the Administrative Rules of the Department of Land and Natural Resources, Title 13-1, Chapter 2 (Regulation 4) which regulates uses in the district), means a practice, both by government and private landowners, of protecting and preserving, by judicious development and utilization, the natural and scenic resources attendant to land, including territorial waters within the state, to ensure optimum long-term benefits for the inhabitants of the state.

The majority of the property is in the General (G) subzone of the Conservation District. The objective of this subzone is to designate open space where specific conservation uses may not be defined, but where urban use would be premature. The General subzone includes: lands with topography, soils, climate or other related environmental factors that may not be normally adaptable or presently needed for urban, rural or agricultural use; and lands suitable for farming, flower gardening, operation of nurseries or orchards, grazing, including facilities accessory to such uses when said facilities are compatible with the natural physical environment. The HOST property is not suitable for the above uses nor does it have topography, soils, climate or other environmental factors which may not be normally adaptable for urban, rural or agricultural uses. The property is suitable, however, for the uses proposed in the HOST Park plan and it is now needed for urban use.

The makai portions of the HOST property, are situated within the Resource (R) subzone of the Conservation District. The objective of this subzone is to develop, with proper management, areas to ensure sustained use of the natural resources of the area. The Resource subzone includes: lands necessary for providing future parkland and lands presently used for national, state, county or private parks; lands suitable for growing and harvesting of commercial timber or other forest products; lands suitable for outdoor recreational uses such as hunting, fishing, hiking, camping and picnicking; offshore islands of the State of Hawaii; lands and territorial waters below the upper reaches of the wash of waves, usually evidenced by the edge of vegetation or by the debris left by the wash of waves; and all territorial waters not expressly assigned to any subzone. The HOST property is not suitable for future parkland nor is it currently in use as a park; the land is not suitable for growing and harvesting of commercial timber or other forest products. Fishing, camping and picnicking occur in the shoreline areas of the site; it is anticipated that these uses will continue even though the park is developed, as is the case at NELH. These lands are part of the petition to reclassify the HOST property to Urban.

At both the NELH and HOST Park sites, lands below the certified shoreline and nearshore waters will remain in the Conservation District. All permitted uses in more restrictive subzones plus aquaculture, artificial reefs, and commercial fishing operations are allowed in the Resource subzone. The proposed expansion of the ocean research corridor would be a conditional use in this subzone.

E. HAWAII COUNTY GENERAL PLAN

The General Plan for the County of Hawaii contains general economic policies which pertain to the development of the proposed projects:

- o Strive for an economic climate which provides its residents an opportunity for choice of occupation; and,
- o Strive for diversification of the economy by strengthening existing industries and attracting new endeavors.

An energy goal of the General Plan, directly applicable to the proposed developments, is: establish the Big Island as a demonstration community for the development and use of natural energy resources. Energy policies applicable to the projects include:

- o Encourage the development of alternative energy resources;
- o Encourage the expansion of energy research industry; and,
- o Ensure a proper balance between the development of alternative energy resources and the preservation of environmental fitness.

A housing policy of the County General Plan states that ..."Large industries which create a demand for housing shall provide employee housing based upon a ratio to be determined by an analysis of the locality's needs." Although the uncertainty inherent in the population and housing needs projections for the HOST Park and the NELH expansion preclude the development of specific ratios at this time, the situation will be monitored and, in response to demonstrated needs, the state will take whatever appropriate actions are required in order to insure that development of HOST Park and expansion of NELH do not exacerbate the West Hawaii housing situation.

The County of Hawaii General Plan Land Use Pattern Allocation Guide (LUPAG) Map designates the majority of the HOST property for industrial use; no General Plan amendment will be required. The NELH site is also designated Industrial in the General Plan. The industrial uses proposed for HOST Park and NELH expansion are in conformance to the County Plan. A strip of the HOST Park property along Queen Kaahumanu Highway is designated as Conservation. This area will be left open or landscaped to conform to the General Plan requirements.

F. HAWAII COUNTY SPECIAL MANAGEMENT AREA

In the Keahole area, the special management area runs from the ocean to Queen Kaahumanu Highway. A Special Management Area (SMA) Use Permit will be required before development can occur on the HOST property. An amended SMA may also be required for NELH in order to allow the proposed expanded uses.

The proposed developments meet the County of Hawaii Special Management Area Guidelines in the following manner:

- o There will be no dredging, filling or otherwise altering any bay, estuary, salt marsh, river mouth, slough or lagoon;
- o As currently planned, the developments will not substantially reduce the size of any beach or any other area suitable for public recreation;
- o Except for areas where pumps or pipes may traverse the shoreline (and it is anticipated that these will either be buried or pose minimal obstruction), the developments will not reduce or impose restrictions upon public access to tidal and submerged lands, beaches, portions of rivers and streams within the SMA and the mean high tide line where there is no beach. Restrictions may be in effect during construction activities, these will not be permanent. In addition, the beach areas may have to be managed in the future in order to preserve the existing eco-systems and to minimize littering and vandalism.
- o The developments are not expected to substantially interfere with the line of site toward the sea from Queen Kaahumanu Highway because of the change in elevation and the necessary low rise character of any structures as regulated under Department of Transportation, Federal Aviation Administration, Federal Air Regulation 77. The presence of pipes, ponds, header tanks, and other HOST Park facilities may detract from this view. This impact should be partially mitigated by the design guidelines and landscaping plan which will be incorporated in the HOST Park Development Rules. NELH is at a great enough distance from the highway that facilities there should not interfere with or detract from views to the sea.
- o As discussed in this EIS, the proposed developments should not adversely affect water quality, existing areas of open water free of visible structures, existing and potential fisheries and fishing grounds, wildlife habitats (with the possible exception of resident invertebrates and exotic mammals), estuarine sanctuaries, or potential or existing agricultural uses of the land. Monitoring of water quality and marine resources will insure that the developments will continue to meet these conditions.

G. HAWAII COUNTY ZONING AND SUBDIVISION ORDINANCES

NELH is presently zoned General Industrial (MG-1a) and no further changes will be required. HOST Park is anticipated to request a zoning change to General Industrial (MG-3a). All of the uses proposed for HOST Park are permitted in this zoning district.

It is anticipated that HOST Park and NELH will individually apply for a Planned Unit Development (P.U.D.). The purpose of P.U.D. is to encourage comprehensive site planning productive of optimum adaptation of development to the land by allowing diversification in the relationships of various uses, buildings, structures, open spaces and yards, building heights, and lot sizes in planned building groups while insuring that the intent of the zoning will be observed. Because the development of HOST Park and NELH is expected to be incremental, and individual tenant requirements are unknown, it is anticipated that partial approval of the P.U.D. will be requested.

H. POLICIES AND PLANS INCORPORATED IN THIS EIS BY REFERENCE

Environmental Quality: Chapter 344 HRS-State Environmental Policy Act -- Conforms

Air Quality: Clean Air Act, as amended (42 U.S.C. 1857h-7 et seq.) -- No effect expected

Fish and Wildlife Habitat: Fish and Wildlife Coordination Act (16 U.S.C. Sec.661 et seq.) -- To be determined

Historic and Cultural Properties: National Historic Preservation Act of 1966, as amended (16 U.S.C. 1251 et seq.) - No effect

I. AN INDICATION OF WHAT OTHER INTERESTS AND CONSIDERATIONS OF GOVERNMENTAL POLICIES ARE THOUGHT TO OFFSET THE ADVERSE ENVIRONMENTAL EFFECTS OF THE PROPOSED ACTION

The most significant manner in which the proposed actions fulfill governmental policies, and therefore is thought to offset any adverse effects, is through the satisfaction of the state and county goals which encourage increased employment opportunities and the provision of facilities in suitable locations which would support Hawaii's industries. In addition, the proposed mariculture uses would be supportive of the Hawaii State Plan objectives and policies for the economy because it would expand Hawaii's aquaculture base, which is considered a "potential growth activity." The proposed projects are also supportive of the priority direction for population growth and distribution by generating employment on a neighbor island.

The various federal, state and county permits required for implementation of the proposed projects will impose conditions and restrictions that will help insure that adverse environmental impacts are properly monitored and mitigated. The most significant consideration that will offset adverse effects is the importance of the pristine quality of the nearshore and offshore water resource to the success of both

NELH and HOST Park. This will ensure that all activities, whether on land or in the water, will be monitored to insure that the integrity of these waters is not compromised.

PART VI: LIST OF NECESSARY APPROVALS

HOST Park:

State Land Use Commission: Boundary Amendment -- Conservation To Urban

Hawaii County Zoning Change from Open to MG 3a

Hawaii County Special Management Area Use Permit

Hawaii County Planned Unit Development

Shoreline Setback Variance

Federal Aviation Agency (FAA) Review and Approval

Army Corps of Engineers Permit For Structures In Navigable Waters

CZM Consistency Review

U.I.C Permit (State DOH if injection wells are used)

NELH:

Hawaii County Special Management Area Use Permit

Hawaii County Planned Unit Development (Future)

Shoreline Setback Variance

FAA Review

Conservation District Use Permit, Department of Land and Natural Resources:
Expanded Ocean Research Corridor and Construction of Pipes and Pumps.

U.S. Army Corps of Engineers Permit For Construction in Navigable Waters

CZM Consistency Review

Department of Health UIC Permit (if injection wells are used)

NPDES Permit For Outfall

Note: Both facilities will require various County of Hawaii construction permits. Changes may also be required by the State Departments of Agriculture and Health, depending on types of species proposed for mariculture operations.

PART VII: SUMMARY OF UNRESOLVED ISSUES

- o The infrastructure requirements of firms that will eventually locate at HOST Park and NELH, particularly their ocean water needs, are unknown at the present time. Therefore, pipe sizes and flows for ocean water supply systems that will be constructed after the initial increment are estimates.
- o "No build" areas along the shorelines of HOST Park and NELH have not been specifically identified as yet. They will be designated after the archaeological management plan has been completed, and prior to the filing of the CDUA for the expanded ocean use corridor.
- o It has not been determined as yet whether the State Department of Transportation will allow HTDC to underbuild the existing 69-kv line from the substation at the airport or whether another substation will have to be constructed near the entrance to the park site.
- o Both HOST Park and NELH are in the process of refining their development plans. The final plans will be adopted prior to construction activities taking place. Many details concerning the required infrastructure, design guidelines, landscaping, etc. have yet to be resolved. The EIS attempted, within the framework of development scenarios, to anticipate the "worst case" situations in order to adequately disclose all potential environmental impacts of the developments. The final plans are expected to reflect the conditions described in the EIS and to incorporate appropriate measures to mitigate potential adverse impacts.
- o The traffic assessment was based on employment assumptions for each development scenario. Measures to mitigate the potential increase in traffic are not resolved. The traffic situation will be continually monitored as development progresses so that additional highway improvements can be made as required.
- o Although a potential employee housing problem generated by the proposed development was recognized, no specific solution was identified. This is because, unlike a resort development, the actual number of employees and their housing needs is unknown at the present time. The rate of development, and consequently the absorption of in-migrant employees into the community, is expected to be gradual. Unlike the opening of a new hotel, all of the employees projected for full development of the facilities will not be hired at one time, the process could take up to ten years. Both HTDC and NELH will monitor the situation carefully and work closely with the County of Hawaii to achieve appropriate solutions to employee housing needs.
- o Various options for management of the HOST Park and NELH facilities are under consideration. A management plan will be adopted prior to acceptance of the first tenants at HOST Park. NELH is in the process of revising its management procedures. Cooperation and coordination on management aspects between the two facilities is being explored.

- o Policies for tenant acceptance at HOST Park are presently in draft form. The final version of the policies will be adopted by the HTDC Board in the near future.
- o The question of public access and controlling public use of the beach areas is currently being discussed. These questions will be resolved in coordination with Hawaii County officials.

**PART VIII: AGENCIES, ORGANIZATIONS AND INDIVIDUALS CONSULTED IN
THE PREPARATION OF THE ENVIRONMENTAL IMPACT STATEMENT**

A. AGENCIES, ORGANIZATIONS AND INDIVIDUALS CONTACTED

The following individuals and firms were contacted for professional services and/or specialized advice during the planning process and/or preparation of the EIS. Sub-consultants in the preparation of this EIS are indicated with an asterisk (*).

*Edward K. Noda & Associates	Oceanographic Consultants
*Dames & Moore	Hydrology and Seawater Return Flow Disposal
*Char & Associates	Vegetation and Fauna
*Parsons, Brinckerhoff, Quade & Douglas	Traffic Impact
*GK & Associates	Water Quality, Marine Biology and Ocean-Based Recreation
*Decision Analysts Hawaii, Inc. and Community Resources, Inc.	Socio-Economic Impacts
*Fukunaga & Associates, Inc.	Drainage and Water Resources
*Helber, Hastert, Van Horn & Kimura, Planners	Graphics and Mapping

Federal Agencies

Department of the Army

Mr. Mike Lee Mr. John Emmerson Mr. Warren Kanai	Corps of Engineers
-------------------------------------------------------	--------------------

Department of Transportation

Mr. David Welhouse	Federal Aviation Administration
--------------------	---------------------------------

Environmental Protection Agency,
Region IX

State Legislature

House of Representatives

Honorable Peter T. Apo
Honorable Virginia Isbell

Honorable Calvin Say
Honorable Ken Kiyabu

Senate

Honorable James Aki
Honorable Mamoru Yamasaki

State Agencies

Department of Agriculture

Mr. Paul Schwind Chief Planner

Department of Education

Mr. Ed Matsushige Student Demographic Specialist
Mr. Howard Lau Planner

Department of Health

Mr. Donald McGrath Director's Office
Mr. Dayton "Duke" Fraim Environmental Permits Branch

Department of Land & Natural Resources

Mr. Susumo Ono Chairman

Mr. John Corbin Aquaculture Development Program
Mr. Bill Brewer

Mr. Paul Kawamoto Aquatic Resources
Mr. Dave Eckert

Mr. James J. Detor Land Management
Mr. M. Miyashiro
Mr. Duane Kanuaha

Mr. Dean Uchida Planning Office

Mr. Ralston Nagata State Parks, Outdoor Recreation
Dr. Ross Cordy and Historic Sites

Department of Planning & Economic
Development

Mr. Kent Keith Director

Dr. Takeshi Yoshihara Energy Division
Mr. Gerald Lesperance

Mr. Abe Mitsuda Land Division

Mr. Richard Poirier Planning Division

Department of Transportation

Mr. Robert Chun Airports Division

Natural Energy Laboratory of Hawaii

Board of Directors:

Mr. Jack P. Huizingh	Executive Director
Dr. Thomas Daniel	Laboratory Director
Mr. Jan C. War	Operations Manager
Ms. Barbara J. Lee	
Mr. Stephen B. Wilson	
Ms. Kelen Dunford	
Mr. James W. Placek	
Mr. Kent Merrill	
Ms. Catherine Yamashita	
Mr. Donald Lehfeldt	

High Technology Development
Corporation

Board of Directors

County of Hawaii

County Council

Ms. Lorraine Jichaku	Chairman, Economic Development Committee
Mr. Stuart Kerns	Staff

Office of Housing and Community Development

Mr. Scott Leithead	Administrator
Mr. William Moore	Planner

Planning Department

Mr. Albert Lono Lyman	Director
Ms. Ilima Piianaia	Deputy Director
Mr. Norman Hayashi	
Mr. Ed Cheplic	
Mr. Rodney Nakano	

Department of Water Supply

Mr. William Sewake	Director
Mr. George Tengen	

Police Department

Inspector Robert Pung

Public Works Department

Mr. Harold Sugiyama

Director, Sewers and Sanitation Bureau

Department of Parks & Recreation

Ms. Pat Engelhard

Director

Fire Department

Albert Kaaihili

Kailua Station Rescue Specialist

Individuals and Organizations

Mr. Gerald Cysewski

Cyanotech, Inc.

Mrs. Frances Schobel

Friends of Kamao Point

Mr. Alvah Nakamura

Hawaii Electric Light Company, Inc.

Mr. Ed Nakamoto

Mr. Dennis Tanigawa

Mr. Pete L'Orange

Hawaii Leeward Planning Conference

Mr. George Lockwood

Hawaiian Abalone Farms

Dr. E. Peter Scrivani

Mr. Alan LLoyd

Hawaiian Electric Industries, Inc.

Ms. Moanikeala Akaka

Office of Hawaiian Affairs

Mr. Kaipo Akaka

Concerned Hawaiians

Mr. John K. Spencer

Mr. Ka'ipo DeGuair

Mr. Skippy Doane

Mr. Gordon Leslie

B. AGENCIES, ORGANIZATIONS & INDIVIDUALS WHO RECEIVED A COPY OF THE NOP

The EIS Preparation Notice (NOP) was officially filed with the State Office of Environmental Quality Control on March 18, 1985. Review and comments on the NOP were requested on or before March 23, 1985. Because of the delay in publishing the draft EIS, HTDC honored all comments up to June 28, 1985. As of then a total of 27 comments were received and 2 letters were received by individuals requesting to be consulted parties. Of the comments received, 12 required no answer. Copies of the NOP were sent to the individuals requesting to be consulted parties, however, no further comment was received from either of them. The following agencies, organizations and individuals received copies of the NOP; those with asterisks responded and those respondents identified with double asterisks made substantive comments which are included in this section of the draft EIS.

Federal

Advisory Council on Historic Preservation
Department of Agriculture
Soil Conservation Service

Department of the Army
** Army Engineer District

Department of Commerce
** National Oceanic & Atmospheric Administration

Department of Energy
* Department of Housing and Urban Development

Department of the Interior
Environmental Services
Fish & Wildlife Service
** Geological Survey

Department of Transportation
** Federal Aviation Administration
* Federal Highway Administration
* United States Coast Guard

** Environmental Protection Agency, Region IX

Western Pacific Fisheries Council

State

Governor
Board of Directors, High Technology Development Corporation
Board of Directors, Natural Energy Laboratory of Hawaii
* Department of Accounting & General Services

- ** Department of Agriculture
- * Department of Budget and Finance
- * Department of Defense
- * Department of Education
- ** Department of Health
- ** Department of Land & Natural Resources
- ** Department of Planning and Economic Development
- Department of Social Services and Housing
- Department of Transportation
- Land Use Commission
- Office of Environmental Quality Control
- Office of Hawaiian Affairs
- University of Hawaii
 - Department of Oceanography
 - College of Engineering
 - College of Tropical Agriculture
 - Energy Research Coordinator
- ** Environmental Center
 - Hawaii Institute of Geophysics
 - Hawaii Institute of Marine Biology
 - Hawaii Natural Energy Institute
 - Pacific International Center For High Technology Research
 - Sea Grant Marine Advisory Program
- * Water Resources Research Center

State Legislature

Senate

- President
- Senators, Island of Hawaii
- Senate Committees
 - Agriculture
 - Economic Development
 - Energy
 - Finance
 - Tourism and Recreation

House of Representatives

- Speaker
- ** Representatives, Island of Hawaii
- House Committees
 - Agriculture
 - Finance
 - Ocean & Marine Resources
 - Planning, Energy, Ecology and Environmental Protection
 - Water, Land Use, Development & Hawaiian Affairs

County of Hawaii

- ** Mayor's Office
 - County Council
 - Chairman and Members
- ** Committee on Economic Development
 - Fire Department
 - Housing and Community Development Office
- ** Parks and Recreation
- ** Planning Department
 - Planning Commission
 - Police Department
- ** Public Works Department
 - Research and Development
 - Water Supply Department

Organizations and Individuals

- Big Island Fish and Game Association
- Conservation Council, Hawaii Island
- Construction Industry Legislative Organization (CILO)
- Mr. Gerald Cysewski
- Mr. Thomas Daniels
- Hawaii Audubon Society
- ** Hawaii Electric Light Company (HELCO)
 - Hawaii Island Board of Realtors
 - Hawaii Island Chamber of Commerce
- ** Hawaii Leeward Planning Conference
 - Hawaii Society of Professional Engineers, Big Island Chapter
 - Hawaiian Electric Industries, Inc.
- ** Hawaiian Telephone Company
 - Hawaii's Thousand Friends
 - Kona Board of Realtors
 - Kona Charter Skippers Association
 - Kona Coast Chamber of Commerce
 - Kona Jaycees
 - Kona Mauka Trollers, Inc.
 - Mr. George Lockwood
 - Life of the Land
 - Marine Advisory Program, Hawaii Agent (Howard Takata)
 - Pacific Gamefish Association, Kailua-Kona
 - Sierra Club, Hawaii Chapter

Requests to be Consulted - No Further Comments

- Roger Harris, Mauna Lani Resort
- Dr. Frank Howarth, Bishop Museum



DEPARTMENT OF THE ARMY
U. S. ARMY ENGINEER DISTRICT, HONOLULU
FT SHAFTER, HAWAII 96858

April 3, 1985

Mr. William M. Bass, Jr.
Executive Director
High Technology Development Corp.
P. O. Box 2359
Honolulu, Hawaii 96804

Dear Mr. Bass:

Thank you for the opportunity to review and comment on the FIS Preparation Notice for the Development Plan for the Hawaii Ocean Science and Technology Park and Proposed Expansion of the Natural Energy Laboratory of Hawaii at Keahole, North Kona, Hawaii. The following comments are offered:

- a. Seawater pipelines and any other work in the ocean will require a Department of the Army permit. Please contact Operations Branch at 438-9258 for any questions.
- b. The flood hazards have been addressed on page 15 of the FIS preparation notice. As noted in the report, coastline areas are designated Zone A4 and V15. The 100-year tsunami elevation ranges from 7 to 9 feet referenced to mean sea level, as shown in the reduced copy of the Flood Insurance Rate Map of the North Kona Coast from Keahole Point to Puhili Point (Enclosure 1).

Sincerely,

Kisuk Cheung
Kisuk Cheung
Chief, Engineering Division

Enclosure



DEPARTMENT OF THE ARMY
U. S. ARMY ENGINEER DISTRICT, HONOLULU
FT SHAFTER, HAWAII 96858

April 3, 1985

Mr. William M. Bass, Jr.
Executive Director
High Technology Development Corp.
P. O. Box 2359
Honolulu, Hawaii 96804

Dear Mr. Bass:

Thank you for the opportunity to review and comment on the FIS Preparation Notice for the Development Plan for the Hawaii Ocean Science and Technology Park and Proposed Expansion of the Natural Energy Laboratory of Hawaii at Keahole, North Kona, Hawaii. The following comments are offered:

- a. Seawater pipelines and any other work in the ocean will require a Department of the Army permit. Please contact Operations Branch at 438-9258 for any questions.
- b. The flood hazards have been addressed on page 15 of the FIS preparation notice. As noted in the report, coastline areas are designated Zone A4 and V15. The 100-year tsunami elevation ranges from 7 to 9 feet referenced to mean sea level, as shown in the reduced copy of the Flood Insurance Rate Map of the North Kona Coast from Keahole Point to Puhili Point (Enclosure 1).

Sincerely,

Kisuk Cheung
Chief, Engineering Division

Enclosure

GEORGE R. ARNOLD
 K. TIM VEE
 WILLIAM M. BASS, JR.

Mailing Address: P.O. Box 2150 Honolulu, Hawaii 96804

HIGH TECHNOLOGY DEVELOPMENT CORPORATION

Central Post Office Plaza, 220 South King Street, Suite 212
 Honolulu, Hawaii 96819 (808) 548-8844

April 10, 1985

Mr. Kisuk Cheung
 Chief, Engineering Division
 Department of the Army
 U.S. Army Engineer District, Honolulu
 Ft. Shafter, Hawaii 96858

Dear Mr. Cheung:

Subject: Environmental Impact Statement Preparation Notice-Development Plan for HST Park and Proposed Expansion of NEJH at Keahole, North Kona, Hawaii.

Thank you for commenting on the subject preparation notice and for enclosing a reduced copy of the Flood Insurance Rate Map of the north Kona Coast from Keahole Point to Puhili Point. Flood and tsunami hazards were specifically considered when developing the HST Park conceptual master plan.

We are aware that Department of Army permits are required for pipelines and any other work in the ocean and have included these in our permit schedule for the proposed park. We will be contacting your operations branch during the planning and design process for further information concerning the requirements for obtaining these permits.

Very truly yours,

William M. Bass, Jr.
 William M. Bass, Jr.
 Executive Director

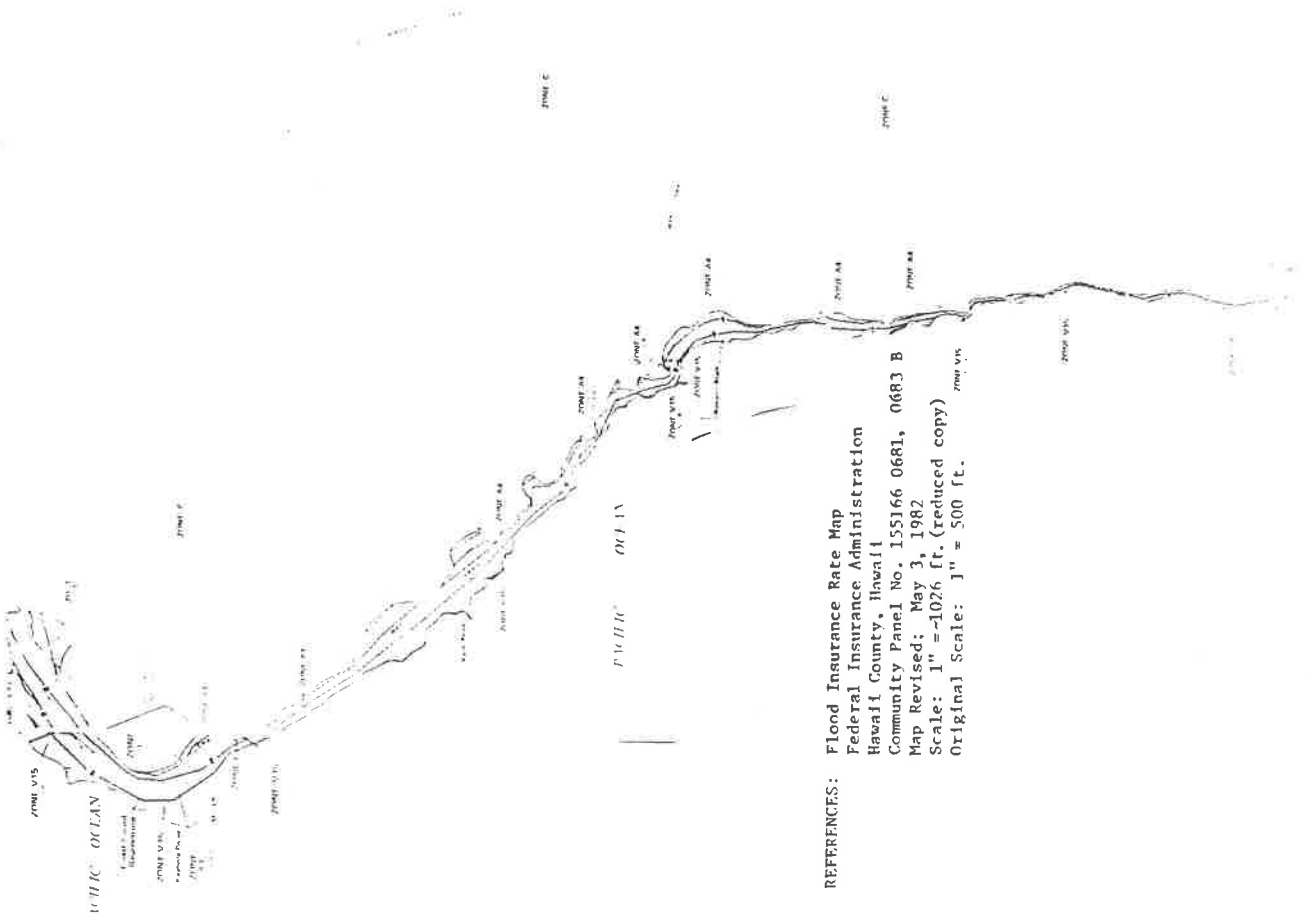

REFERENCES: Flood Insurance Rate Map
 Federal Insurance Administration
 Hawaii County, Hawaii
 Community Panel No. 155166 0681, 0683 B
 Map Revised: May 3, 1982
 Scale: 1" = 1026 ft. (reduced copy)
 Original Scale: 1" = 500 ft.



U.S. DEPARTMENT OF COMMERCE
National Oceanic and Atmospheric Administration

NATIONAL MARINE FISHERIES SERVICE

Southwest Region

Western Pacific Program Office

P. O. Box 3830

Honolulu, Hawaii 96812

April 19, 1985

F/SWRI:LIN

Mr. William M. Bass, Jr.
Executive Director
High Technology Development Corporation
Central Pacific Plaza, Suite 252
220 South King Street
Honolulu, Hawaii 96813

Dear Mr. Bass:

Subject: Environmental Impact Statement (EIS) Preparation Notice - Development Plan For The Hawaii Ocean Science and Technology (HOST) Park and Proposed Expansion of the National Energy Laboratory of Hawaii (NELH) at Keahole, North Kona, Hawaii.

The National Marine Fisheries Service (NMFS) has reviewed the subject EIS Preparation Notice and environmental assessment for the proposed projects at Keahole, North Kona, Hawaii. The following comments and suggestions concerning potential impacts on living marine resources under NMFS jurisdiction are offered for your consideration.

General Comments

Of major concern to NMFS is the proposed installation of permanent pipes in the ocean offshore at Keahole Point to support the ocean water requirements of two projects. The proposed EIS should contain an assessment of the impacts of pipeline installation on the coral reef communities immediately offshore on the shallow basalt pavement ledge and the upper portion of the reef slope. An assessment is also needed on the ability of the relatively narrow NELH research corridor to accommodate the number of pipelines envisioned. Details are needed on proposed construction activities on the shoreline, within the NELH research corridor and offshore of the HOST Park. This would include proposed dredging, filling, blasting and potential discharge of pollutants.

We realize the success of both projects depends on maintaining the high quality of ocean water found immediately off Keahole Point. These waters support important commercial and recreational fisheries of great significance to the economy of the Kona region of Hawaii. Nearshore waters in the area also contain habitat and support several species listed under the Endangered Species Act of 1973, which fall under NMFS jurisdiction. Specifically these are the threatened green turtle (*Chelonia mydas*), found year round, and the endangered humpback whale (*Megaptera novaeangliae*), which occurs seasonally in nearshore

waters. Potential impacts from the proposed projects on pelagic and demersal fishery resources as well as threatened and endangered species should be assessed.

Specific Comments

4.0 Marine Biota, Pelagic Fish.

Page 17, paragraph 2. This paragraph in the assessment contains a number of names of pelagic game fish. The commas should be deleted between the generic and specific scientific names. One of the most important pelagic species, the yellowfin tuna (*Thunnus albacares*), was omitted.

The section on marine biota should contain a description of important demersal (i.e., bottomfish, deep water shrimp) resources which occur within or in close proximity to the proposed project location.

C. Recreational Resources

Page 21, paragraph 3. This paragraph states that trawling is an important recreational activity. We suggest this activity be corrected to read trawling.

Thank you for the opportunity to comment on the proposed projects at this early stage of the development. Please send us a copy of the draft EIS as soon as it has been completed.

Sincerely yours,

David E. Gates
David E. Gates
Administrator

cc: F/SWR, Terminal Is., CA
F/M4, Washington, D.C.
EPA (Region IX, P-5)
FWS, Honolulu
Corps of Engineers, Honolulu
Hawaii State Div. of Aquatic Resources.

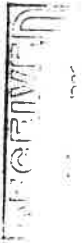

HIGH TECHNOLOGY DEVELOPMENT CORPORATION

Central Pacific Plaza, 220 South King Street, Suite 252
Honolulu, Hawaii 96813
Telephone (808) 548-6946

GEORGE R. ARIVOSHI
K. TIM YEE
WILLIAM M. BASS, JR.
President

Mailing Address: P.O. Box 2359 Honolulu Hawaii 96804

June 21, 1985

Mr. Doyle E. Gates, Administrator
National Marine Fisheries Service
U.S. Department of Commerce
National Oceanic and Atmospheric Administration
Southwest Region, Western Pacific Program Office
P.O. Box 3830
Honolulu, Hawaii 96813

Dear Mr. Gates:

Subject: Environmental Impact Statement Preparation Notice--
Development Plan for the Hawaii Ocean Science & Technology Park and
Proposed Expansion of the Natural Energy Laboratory of Hawaii at
Keahole, North Kona, Hawaii

Thank you for your comments on the subject NOP. To respond
to your general comments:

The draft EIS will contain an assessment of the impacts of
pipeline installation on coral reef communities.

The NEIH research corridor is proposed to be expanded to
accommodate additional pipes. The proposed corridor will be
addressed in the draft EIS.

Construction impacts of installing pipes and pumps will be
addressed in the draft EIS.

Endangered species, including the green turtle and the
humpback whale will be addressed in the draft EIS.

Your specific comments have been noted and corrections and
additions will be incorporated in the draft EIS.

We look forward to your comments on the draft EIS. If you
have any further concerns please contact Ms. Marilyn Metz of The
Traverse Group, Inc. at 732-7143.

Very truly yours,

William M. Bass
William M. Bass



U.S. Department of Housing and Urban Development
Honolulu Area Office, Region IX
300 Ala Moana Blvd., Room 3318
Honolulu, Hawaii 96850

85-158

April 17, 1985

High Technology Development Corporation
ATTENTION: Mr. William M. Bass, Jr.
Central Pacific Plaza, Suite 252
220 South King Street
Honolulu, HI 96813

Gentlemen:

SUBJECT: Environmental Impact Statement Preparation Notice -- Development
Plan for the Hawaii Science and Technology Park and Proposed
Expansion of the Natural Energy Laboratory of Hawaii at Keahole,
North Kona, Hawaii

We have reviewed the EIS Preparation Notice for the subject project and
find that it does not impact any HUD programs or projects in the area. We
appreciate the opportunity to review the Notice and look forward to receiving
a copy of the Draft EIS.

Sincerely,

Robert K. Fukuda
Robert K. Fukuda
Manager, 9.25

CC: The Traverse Group, Inc.
ATTENTION: Marilyn C. Metz
P. O. Box 27506
Honolulu, Hawaii 96827





United States Department of the Interior

GEOLOGICAL SURVEY

Water Resources Division
P. O. Box 50166
Honolulu, Hawaii 96850

April 15, 1985

Mr. William M. Bass, Jr.
High Technology Development Corporation
Central Pacific Plaza, Suite 252
220 S. King Street
Honolulu, Hawaii 96813

Dear Mr. Bass:

Subject: Environmental Impact Statement Preparation Notice--Development Plan for the Hawaii Ocean Science & Technology Park and Proposed Expansion of the Natural Energy Laboratory of Hawaii at Keahole, North Kona, Hawaii

The staff of U.S. Geological Survey, Water Resources Division, Hawaii District Office, has reviewed the above document.

We have investigated the general area with deep resistivity soundings. These findings indicate that the area of the proposed development, and particularly the injection well site, is underlain by brackish water. Our findings support the interpretation of Stearns and MacDonald as presented in the map of page 14a of the above statement. We have no further comments to offer at this time.

Thank you for the opportunity to review the document. We are returning your copy for your further use.

Sincerely,

Stanley F. Kapustka
Stanley F. Kapustka
District Chief

Enclosure

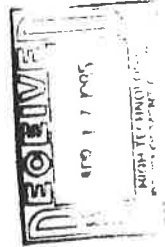

HIGH TECHNOLOGY DEVELOPMENT CORPORATION

Central Pacific Plaza, 220 South King Street, Suite 252
Telephone: (809) 548-8906

GEORGE R. ARYOSHII
Chairman

K. TIM YEE
Chairman

WILLIAM M. BASS, JR.
Executive Director

Mailing Address: P.O. Box 2359, Honolulu, Hawaii 96804

June 21, 1985

Mr. Stanley F. Kapustka, District Chief
U.S. Department of the Interior
Water Resources Division
P.O. Box 50166
Honolulu, Hawaii 96850

Dear Mr. Kapustka:

Subject: Environmental Impact Statement Preparation Notice--Development Plan for the Hawaii Ocean Science & Technology Park and Proposed Expansion of the Natural Energy Laboratory of Hawaii at Keahole, North Kona, Hawaii

Thank you for your comments confirming the interpretation of Stearns and MacDonald as presented on page 14a of the NOP. A more detailed analysis of the hydrology of the area is being prepared by Dames & Moore. Their report will appear in the draft EIS.

We appreciate your review of the NOP and we hope that you will comment on the draft EIS.

Sincerely,

William M. Bass
William M. Bass
Executive Director



U.S. Department
of Transportation
Federal Aviation
Administration

AIRPORTS DISTRICT OFFICE
BOX 50244
HONOLULU, HI 96850-0001
Telephone: (808) 546-7129

April 4, 1985

Mr. William M. Bass, Jr.
Executive Director
High Technology Development
Corporation
P.O. Box 2359
Honolulu, Hawaii 96804

Dear Mr. Bass:

We have reviewed the Environmental Impact Statement Preparation Notice - Development Plan for HOST Park and Proposed Expansion of NELH at Keahole, North Kona, Hawaii. We have no comments per se on the environmental assessment (EA); however, you may wish to address these additional items in the environmental impact statement (EIS):

1. Under Part III, the noise exposure from the aircraft, the height restrictions of the airport, and any proposed development at the airport should be included.
2. Under Part IV, the potential for bird attractants and the need for compatible land use with the airport should be addressed.

Thank you for the opportunity to review the EA and will look forward to transmittal of the EIS. We are available to discuss our additions, the EIS preparation or the effects on Keahole Airport.

Sincerely,

DAVID J. MELHOUSE
Planning Engineer

Henry A. Sumida
Airports District Office Manager

CC: Dr. Shimada, State DOT



HIGH TECHNOLOGY DEVELOPMENT CORPORATION

Central Pacific Plaza, 220 South King Street, Suite 252
Honolulu, HI 96813-4006
Telephone: (808) 546-8006

GEORGE R. AIRWAYS
Executive Director
K. TIM JEFF
Executive Director
WILLIAM M. BASS, JR.
Executive Director
A. J. JAMES
Executive Director

Mailing Address: P.O. Box 2359 Honolulu, Hawaii 96804

April 10, 1985

Mr. David J. Melhouse
Planning Engineer
Federal Aviation Administration
Airports District Office
Box 50244
Honolulu, HI 96850-0001

Dear Melhouse:

Subject: Environmental Impact Statement Preparation Notice-Development Plan for HOST Park and Proposed Expansion of NELH at Keahole, North Kona, Hawaii.

Thank you for your comments concerning additional items which should be addressed in the forthcoming EIS for the proposed project. Height restrictions, airport development and the potential for bird attractants will be discussed in the EIS. Ms. Marilyn Metz of The Traverse Group, Inc. will be contacting you during the preparation of the EIS to discuss these items and any other concerns that you may have regarding the efforts of the proposed project on Keahole Airport.

Very truly yours,

WILLIAM M. BASS, JR.
Executive Director



U.S. DEPARTMENT OF TRANSPORTATION
FEDERAL HIGHWAY ADMINISTRATION

REGION NINE
Hawaii Division
Box 50206

Honolulu, Hawaii 96850

ARIZONA
CALIFORNIA
HAWAII
GUAM
ILLINOIS
INDIANA
IOWA
KANSAS
MICHIGAN
MINNESOTA
MISSOURI
NEBRASKA
NEW YORK
OHIO
PENNSYLVANIA
RHODE ISLAND
SOUTH CAROLINA
Tennessee
Texas
VIRGINIA
WASHINGTON
WEST VIRGINIA
Wisconsin
Wyoming

March 29, 1985
IN REPLY REFER TO

HFC-HI

Mr. William M. Bass, Jr.
High Technology Development Corporation
Central Pacific Plaza, Suite 252
220 South King Street
Honolulu, Hawaii 96813

Dear Mr. Bass:

Subject: Environmental Impact Statement Preparation Notice -- Development
Plan For The Hawaii Ocean Science & Technology Park and Proposed
Expansion of the Natural Energy Laboratory of Hawaii At Keahole,
North Kona, Hawaii.

Thank you for the opportunity to review the subject document. The Federal
Highway Administration has no comments to make on the proposal undertaking.
We will not need to review the Draft EIS.

Sincerely yours,

H. Kusumoto

By: *N. L. Arthur*
N. L. Arthur
Assistant Division Administrator



Commander (dpl)
Fourteenth Coast Guard District

Prince Kalaianole
Federal Building
300 Ala Moana Blvd
Honolulu, Hawaii 96850
Phone: (808) 546-2861

16475
Serial No. 5/097
J April 1985

Mr. William M. Bass, Jr.
High Technology Development Corporation
Central Pacific Plaza, Suite 252
220 South King Street
Honolulu, Hawaii 96813

Dear Mr. Bass:

The Fourteenth Coast Guard District has reviewed the
ENVIRONMENTAL IMPACT STATEMENT PREPARATION NOTICE OF DEVELOPMENT
PLAN FOR THE HAWAII OCEAN SCIENCE & TECHNOLOGY PARK AND EXPANSION
OF THE NATURAL ENERGY LABORATORY OF HAWAII AT KEAHOLE, NORTH
KONA, HAWAII and has no objection or constructive comments to
offer at the present time.

Sincerely,

J. F. Milbrand
J. F. MILBRAND
Commander, U. S. Coast Guard
District Planning Officer
By direction of Commander,
Fourteenth Coast Guard District

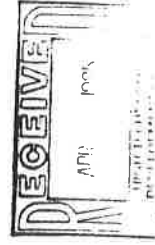



UNITED STATES ENVIRONMENTAL PROTECTION AGENCY

REGION IX
215 Fremont Street
San Francisco, Ca. 94105

Mr. William M. Bass, Jr.
High Technology Development Corporation
Central Pacific Plaza, Suite 252
220 South King Street
Honolulu, Hawaii 96813

Re: Environmental Impact Statement Preparation Notice:
HI Ocean Science & Technology Park, and Proposed
Expansion of Natural Energy Laboratory of HI at
Koahole, North Kona, Hawaii

Dear Mr. Bass:

We have reviewed the Notice of Preparation referenced above and offer the following comments.

Under Section 404 of the Clean Water Act (CWA), the U.S. Army Corps of Engineers (Corps) issues permits for the discharge of dredged or fill material into waters of the United States including wetlands. EPA is charged with establishing by regulation, guidelines for evaluating these proposed discharges. These guidelines contain the substantive criteria for evaluating the effects of the project on human health, the aquatic ecosystem, and recreation. These regulations are commonly referred to as the 404(b)(1) guidelines (40 CFR 230). EPA's primary role in reviewing proposed discharges under Section 404 of the CWA is to assure that permits issued by the Corps comply with the 404(b)(1) guidelines.

The referenced Notice identified a total of eight anchialine ponds on the proposed project site. It is unclear from the Notice if the proposed project would result in the filling of these ponds. Anchialine ponds are "waters of the United States", and as such, the filling of these ponds would be subject to a CWA Section 404 permit as described above. In order to determine to what extent Section 404 of the CWA applies to your project, the Draft Environmental Impact Statement (DEIS) should address the following issues:

1. Will there be a discharge of dredged or fill materials to waters of the United States?
2. If yes, where will the discharge occur? What will be the source, quantity, and quality of the materials?
3. What are the existing ecological values of the discharge site?
4. What are the impacts of the discharge?

5. Describe the location of the anchialine ponds, the vegetation associated with them, the organisms found within them, and the ecological values and significance of these ponds (individually and as an ecosystem).
6. Describe practicable alternatives that would avoid the discharge of fill material into anchialine ponds (i.e. revised configuration of the proposed project, reduction in scope of the proposed project, etc.)
7. Describe all mitigation measures to minimize adverse impacts for unavoidable losses.

The 404(b)(1) guidelines include a requirement that no discharge be permitted if an alternative exists which would have less adverse impact on the aquatic ecosystem. Compliance with this requirement is determined by a thorough evaluation of such alternatives. The guidelines also prohibit discharges which will cause or contribute to significant degradation of the waters of the United States resulting in unacceptable adverse impacts. The potential destruction of anchialine ponds are of considerable interest to us because of their values as unique natural resources. EPA will review your project for compliance with these criteria as part of the 404 permitting process.

We understand that you will be initiating discussions with the Corps on the proposed project. Should the Corps determine that a federal environmental impact statement must be prepared pursuant to the requirements of the National Environmental Policy Act, EPA will be providing additional comments to the Corps.

Feel free to direct questions on this matter to Lily Wong of my staff at (415) 974-7194. Please send a copy of the Draft EIS directly Ms. Wong at the above address, Mail Code P-5.

Sincerely yours,

Loretta Kahn Barsamian

Loretta Kahn Barsamian, Chief
Federal Activities Branch
Office of Policy and Management

cc: USACE - Honolulu
USFWS - Honolulu
NMFS - Honolulu

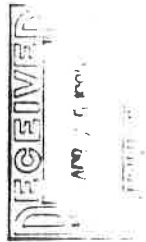

HIGH TECHNOLOGY DEVELOPMENT CORPORATION

Central Pacific Plaza 220 South King Street, Suite 252
Honolulu (808) 548-4000

GEORGE R. ARWOSH
DIRECTOR
K. TIM YEE
MANAGER
WILLIAM M. BASS, JR.
EXECUTIVE DIRECTOR

Mailing Address: P.O. Box 2350 Honolulu Hawaii 96804

June 21, 1985

Ms. Loretta Kahn Barsamian, Chief
Federal Activities Branch
Office of Policy and Management
U.S. Environmental Protection Agency, Region IX
215 Fremont Street
San Francisco, California 94105

Dear Ms. Barsamian:

Subject: Environmental Impact Statement Preparation Notice--
Development Plan for the Hawaii Ocean Science & Technology Park and
Proposed Expansion of the Natural Energy Laboratory of Hawaii at
Keahole, North Kona, Hawaii

Thank you for reviewing and commenting on the subject preparation notice. Anachaline ponds will be addressed in the draft EIS. At the present time we are not certain if all of the ponds that were mentioned in the NOP are still in existence. The Army Corps of Engineers has agreed to visit the sites and verify the number of ponds and their location. As stated in the NOP, the ponds were not considered significant by Maciolek and Brock during their 1975 survey.

There will be no discharge of dredged or fill material into these ponds or surrounding waters. The draft EIS will, however, describe the vegetation associated with and organisms found within any remaining ponds (as reported by Maciolek and Brock). Any potential impacts to the ponds that could occur from development of the proposed project will be disclosed and means to mitigate any potential adverse impacts will be recommended.

We look forward to your comments on the draft EIS.

Very truly yours,

William M. Bass
William M. Bass
Executive Director



STATE OF HAWAII
DEPARTMENT OF ACCOUNTING AND GENERAL SERVICES
DIVISION OF PUBLIC WORKS
P. O. BOX 110, HONOLULU, HAWAII 96810

ASR 0 1985

Mr. William M. Bass, Jr.
High Technology Development Corporation
Central Pacific Plaza, Suite 252
220 South King Street
Honolulu, Hawaii 96813

Dear Mr. Bass:

Subject: Environmental Impact Statement Preparation
Notice - Development Plan for the Hawaii
Ocean Science & Technology Park and Proposed
Expansion of the Natural Energy Laboratory of
Hawaii at Keahole, North Kona, Hawaii

We have reviewed the subject document and have no
comments to offer.

Very truly yours,

T. Tomnaga

TERUANE TOMINAGA
State Public Works Engineer

GA:jk

RECEIVED

APR 21 1985

GEORGE R. ARYOSHI
GOVERNOR



State of Hawaii
DEPARTMENT OF AGRICULTURE
1428 So. King Street
Honolulu, Hawaii 96814

April 4, 1985

Mr. William M. Bass, Jr.
High Technology Development Corporation
Central Pacific Plaza, Suite 252
220 South King Street
Honolulu, Hawaii 96813

Dear Mr. Bass:

Subject: Environmental Impact Statement (EIS) Preparation Notice for the Development Plan for the Hawaii Ocean Science and Technology Park and Proposed Expansion of the Natural Energy Laboratory of Hawaii at Ke-ahole, North Kona, Hawaii

The Department of Agriculture has reviewed the subject EIS Preparation Notice and offers the following comment.

The EIS should indicate the projected domestic water demand for the proposed project, and whether existing and proposed domestic water sources are sufficient to meet the needs of all water uses, including agriculture, in the affected area.

We appreciate the opportunity to comment.

Sincerely,

Jack K. Suwa
JACK K. SUWA
Chairman, Board of Agriculture

cc: DPED
Ms. Marilyn C. Metz, Traverse Group, Inc.

JACK K. SUWA
CHAIRPERSON, BOARD OF AGRICULTURE
SUZANNE D. PETERSON
DEPUTY TO THE CHAIRPERSON

Mailing Address:
P. O. Box 22159
Honolulu, Hawaii 96822



HIGH TECHNOLOGY DEVELOPMENT CORPORATION

Central Pacific Plaza, 220 South King Street, Suite 252
Telephone: (808) 548-8006

June 21, 1985

Mailing Address: P.O. Box 2350, Honolulu, Hawaii 96804

GEORGE R. ARYOSHI
GOVERNOR
K. TIM YEE
CHAIRMAN
WILLIAM M. BASS, JR.
EXECUTIVE DIRECTOR

Mr. Jack K. Suwa
Chairman, Board of Agriculture
State of Hawaii Department of Agriculture
1428 So. King Street
Honolulu, Hawaii 96814

Dear Mr. Suwa:

Subject: Environmental Impact Statement Preparation Notice-- Development Plan for the Hawaii Ocean Science & Technology Park and Proposed Expansion of the Natural Energy Laboratory of Hawaii at Keahole, North Kona, Hawaii

Thank you for commenting on the subject notice. The draft EIS will indicate the projected water demand for the proposed project. For your information, the County of Hawaii has given HTDC a water commitment based on credits earned by the State of Hawaii for source development in the area. It is not anticipated that HTDC'S commitment will affect other water users.

Sincerely,

William M. Bass, Jr.
William M. Bass, Jr.
Executive Director



GEORGE R. JANTORSE
GOVERNOR



HAWAII PUBLIC EMPLOYEES HEALTH FUND
EMPLOYEE RETIREMENT SYSTEM
OFFICE OF THE PUBLIC DEFENDER

STATE OF HAWAII
DEPARTMENT OF BUDGET AND FINANCE

STATE CAPITOL
P.O. BOX 150
HONOLULU, HAWAII 96810-0150

March 28, 1985

JOSEPH B. L. HISE
DIRECTOR
DEWEIS K. GOOD
DEPUTY DIRECTOR

DIVISIONS:
BUDGET, PLANNING AND MANAGEMENT
HAWAII INSTITUTE FOR MANAGEMENT
INFORMATION SYSTEMS
ELECTRONIC DATA PROCESSING
FINANCE

GEORGE R. JANTORSE
GOVERNOR



STATE OF HAWAII
DEPARTMENT OF DEFENSE
OFFICE OF THE ADJUTANT GENERAL
7948 DIAMOND HEAD ROAD, HONOLULU, HAWAII 96813

HIENG

APR 4 1985

ALEXIS T. LUM
ADJUTANT GENERAL
ADJUTANT GENERAL
DANIEL K. C. AU
COLONEL
CHIEF ADJUTANT GENERAL

Mr. William M. Bass, Jr.
High Technology Development Corporation
Central Pacific Plaza, Suite 252
220 South King Street
Honolulu, Hawaii 96813

Dear Mr. Bass:

Thank you for the opportunity to comment on your proposed environmental impact statement relating to the development of the Hawaii Ocean Science & Technology Park and expansion of the Natural Energy Laboratory of Hawaii at Keshole, North Kona, Hawaii.

We have no comments to make at this time.

Very truly yours,

Jensen S. I. Hef

JENSEN S. I. HEF

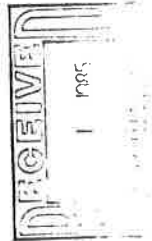

Thank you for providing us the opportunity to review your proposed project Development Plan for the Hawaii Ocean Science and Technology Park and Proposed Expansion of the Natural Energy Laboratory of Hawaii at Keshole, North Kona, Hawaii, Environmental Impact Statement.

We have completed our review and have no comments to offer at this time.

Yours truly,

Ferry M. Matsuda

FERRY M. MATSUDA
MAJ. HANG
Contr. & Engr Officer



GEORGE R. ARYOCHI
GOVERNOR

Francis M. Hatanaka
SUPERINTENDENT



STATE OF HAWAII
DEPARTMENT OF EDUCATION

P. O. BOX 2780
HONOLULU, HAWAII 96813

April 2, 1985

OFFICE OF THE SUPERINTENDENT

Mr. William M. Bass, Jr.
High Technology Development Corporation
Central Pacific Plaza, Suite 252
220 South King Street
Honolulu, Hawaii 96813

Dear Mr. Bass:

SUBJECT: Environmental Impact Statement Preparation Notice -- Development Plan for the Hawaii Ocean Science & Technology Park and Proposed Expansion of the Natural Energy Laboratory of Hawaii at Keahole, North Kona, Hawaii

The Department of Education has no comments to offer on the subject environmental impact statement for the subject developments.

We thank you for the opportunity to review the project.

Sincerely,

Francis M. Hatanaka
Superintendent

FMH:jf

cc: V. Honda
K. Mizuba, Hawaii Dist.

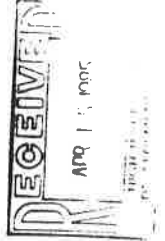

7-3-13 03/par

GEORGE R. ARTHUR
GOVERNOR OF HAWAII



STATE OF HAWAII
DEPARTMENT OF HEALTH
P. O. BOX 3374
HONOLULU, HAWAII 96811

LESLIE S. MATSUHARA
DIRECTOR OF HEALTH

In reply, please refer to
EPHSD

April 22, 1985

April 10, 1985

MEMORANDUM

To: Mr. Kent M. Keith, Director
Department of Planning and Economic Development

From: Director of Health

Subject: Petition No: A85-592
Petitioner: DPED, State of Hawaii
Requested Change: Conservation to Urban
Proposed Use: Ocean science and technology park
Location: Keahole, N. Kona, Hawaii
Area: TMK 7-3-09: 05 (por.) and 7-3-43: 03 (por.)
547 acres (approximately)

Mr. William M. Bass, Jr.
Executive Director
High Technology Development Corporation
Central Pacific Plaza, Suite 252
220 S. King St.
Honolulu, Hawaii 96813

Dear Mr. Bass:

Subject: Environmental Impact Statement Preparation Notice - Development Plan for the Hawaii Ocean Science & Technology Park and Proposed Expansion of the Natural Energy Laboratory of Hawaii at Keahole, N. Kona, Hawaii

Thank you for allowing us to review and comment on the subject request. Attached is a memorandum to the Department of Planning and Economic Development which contains our comments regarding the project. I hope this will be of assistance to you.

Sincerely,

Melvyn S. Matsumura
Deputy Director for
Environmental Health

K5:ao
Attachment

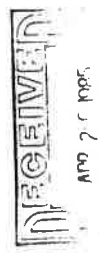

LESLIE S. MATSUMURA

cc: County Planning Department

Thank you for allowing us to review and comment on the subject request.

We submit the following comments for your consideration:

Where applicable, seafood products and shellfish products need to address both Chapter 29, Food and Food Products, and Chapter 35, Shellfish Sanitation, Administrative Rules, Department of Health.

Due to the value this project places on the pristine water quality of the nearshore waters adjacent to the subject project, consideration should be seriously given to a centralized sewerage system for the park tenants.

While the effects on the nearshore waters may not be immediately noticeable, the continuous discharge of domestic sewage and other wastes from the high tech tenants, such as laboratory wastes, solvents, chemicals, biocides, etc. into cesspools, drain fields or shallow wells will have an adverse effect on the nearshore environment (see Section XI.F.).

We realize that the statements are general in nature due to preliminary plans being the sole source of discussion. We, therefore, reserve the right to impose future environmental restrictions on the project at the time final plans are submitted to this office for review.



STATE OF HAWAII
DEPARTMENT OF HEALTH

P. O. BOX 3378
HONOLULU, HAWAII 96813

April 25, 1985

In Reply, please refer to
F 1985

Mr. William M. Bass, Jr.
Executive Director
High Technology Development Corporation
Central Pacific Plaza, Suite 252
220 S. King St.
Honolulu, Hawaii 96813

Dear Mr. Bass:

Subject: Environmental Impact Statement Preparation Notice - Development Plan for the Hawaii Ocean Science & Technology Park and Proposed Expansion of the Natural Energy Laboratory of Hawaii at Keahole, N. Kona, Hawaii

Subsequent to our letter dated April 22, 1985, the following additional comments were generated by our staff.

Surface Disposal of Wastewater

Aquatic developments, proposed by the H.O.S.T. Park, may be subject to one of the following NPIDES regulations:

A. Aquaculture Projects

The EPA defines an aquaculture project as a managed water area in which "discharged pollutants" are used for the maintenance or production of harvestable freshwater, estuarine, or marine plants and animals. The State does not have delegation to issue this type of NPIDES permit. Therefore, aquatic projects involving the use of wastewater sources would be directed to EPA.

B. Concentrated Aquatic Animal Production Facilities

A hatchery, fish farm, or other facility is a concentrated aquatic animal production facility if it contains, grows, or holds fish species or aquatic animals in ponds, raceways, or other similar structures which discharge at least 30 days per year. These operations are point sources subject to the State NPIDES Program. Facilities that may be exempted from permit requirements include the following:

1. Cold Water Aquatic Animals (i.e., Salmon and Abalone):

- a. Facilities which produce less than 70,000 pounds harvest weight of aquatic animals per year; and

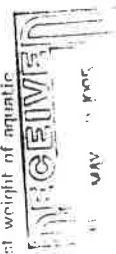

Mr. William M. Bass, Jr.
April 25, 1985
Page 2

- b. Facilities which feed less than 5,000 pounds of food during the calendar month of maximum feeding.
- 2. Warm Water Aquatic Animals (i.e., Prawn, Shrimp and Catfish):
 - a. Closed ponds which discharge only during periods of excess runoff; or
 - b. Facilities which produce less than 100,000 pounds harvest weight of aquatic animals per year.

Specific permit requirements or exemptions will be reviewed by the Department on a case-by-case basis with respect to the water quality standards of the receiving water.

Subsurface Disposal of Wastewater

Even though the subject site is located in an area which has been designated as an exempted area under the Underground Injection Control (UIC) Program, the permitting of the injection wells will depend upon the quality and content of the wastes. If the wastewater will contain industrial wastes, close scrutiny will be required to assure that the wastes are not hazardous in accordance with 40 CFR 261. The disposal of wastes of this nature would result in the classification of the injection wells as Class IV wells which are prohibited under the State UIC Program.

This condition is also applicable to any individual disposal systems which may be proposed by the tenants.

Sincerely,

Leslie S. Matsuda
Deputy Director for
Environmental Health

cc: DHS-A, Hawaii



HIGH TECHNOLOGY DEVELOPMENT CORPORATION

Central Office Plaza, 220 South King Street, Suite 252
Telephone (808) 548-8906

GEORGE R. ARIVOSHI
DIRECTOR
K. TIM YEE
VICE PRESIDENT
WILLIAM M. BASS, JR.
EXECUTIVE DIRECTOR

Mailing Address: P.O. Box 21359, Honolulu, Hawaii 96804

June 21, 1985

Mr. Melvin K. Koizumi
Deputy Director for Environmental Health
State of Hawaii Department of Health
P.O. Box 3378
Honolulu, Hawaii 96801

Dear Mr. Koizumi:

Subject: Environmental Impact Statement Preparation Notice--
Development Plan for the Hawaii Ocean Science &
Technology Park and Proposed Expansion of the Natural
Energy Laboratory of Hawaii at Keahole, North Kona,
Hawaii

Thank you for your comments on the subject notice of preparation. In answer to your specific concerns outlined in your memorandum of April 10, 1985 to the Department of Planning and Economic Development:

1. Seafood products and shellfish products will address all appropriate Department of Health regulations. This will be undertaken at the time a specific request is made to produce either type of product on the subject properties.
2. Sewage systems for both NEIH and HOST Park will be designed to meet all Department of Health regulations.
3. No laboratory wastes, solvents, chemicals, biocides etc. will be discharged into cesspools, drain fields or shallow wells unless appropriate pre-treatment is undertaken. It is vital to the success of both NEIH and HOST Park that the ocean-water resource not be compromised. This will be elaborated on in the draft EIS. In addition, potential impacts from domestic sewage on the nearshore environment will also be addressed.

In response to your additional comments of April 25, 1985:

1. We appreciate your list of NPDES regulations that might apply to HOST Park and NEIH. Those that are applicable will be noted upon. The draft EIS will address various methods of

Mr. Melvin K. Koizumi
June 21, 1985
Page 2

discharges and appropriate mitigating measures for each. All activities will comply with Department of Health and EPA regulations.

2. Injection wells are only being considered for sea water return flows. No other wastes would be permitted. It should be noted, however, that this method of disposal is only one of several being addressed in the draft EIS.

Thank you for your interest in the project. We look forward to receiving your comments on the draft EIS.

Sincerely,

William M. Bass, Jr.
Executive Director

GEORGE R. ARIYOSHI
GOVERNOR OF HAWAII



STATE OF HAWAII
DEPARTMENT OF LAND AND NATURAL RESOURCES
P. O. BOX 421
HONOLULU, HAWAII 96809

SUSUMU ONO, CHAIRMAN
BOARD OF LAND AND NATURAL RESOURCES
EDGAR A. HAMASUJI
DIRECTOR OF THE CHAIRMAN
DIVISIONS:
AGRICULTURE DEVELOPMENT
PROGRAM
HABITAT RESTORATION
CONSERVATION AND
RECREATION DEVELOPMENT
COMPLIANCE
LAND USE AND DEVELOPMENT
STATE PARKS
WATER AND LAND DEVELOPMENT

REF. NO.: CPO-745-85

APR 30 1985

Mr. William M. Bass, Jr.
High Technology Development Corporation
Central Pacific Plaza, Suite 252
220 South King Street
Honolulu, Hawaii 96804

Dear Mr. Bass:

Thank you for notifying us that an environmental impact statement (EIS) is to be prepared for the proposed development of a Hawaii Ocean Science and Technology (HOST) Park and the proposed expansion of the Natural Energy Lab of Hawaii (NELH).

We request that the EIS include the following information:

1. Both the NELH and a portion of the High Technology Development Corporation sites are within State lands set aside under Governor's Executive Order No. 3074 to DOT, Airport Division for Keahole Airport;
2. The NELH site is covered by General Lease No. S-4717 to NELH;
3. The High Technology Development Corporation site within the Keahole Airport land is covered under a pending general lease to High Technology Development Corporation for ocean-related high technology industrial use;
4. Additional area, TMR: 7-3-09; portion 05 (127.211 acres) is covered by a Governor's Executive Order (pending) to High Technology Development Corporation for ocean-related high tech industrial use;
5. The master plan for the high tech park as well as the NELH area and all subleases must be approved by DOT, Airport Division, FAA and DLNR.

Keahole lands consist of layers of very porous lava containing numerous lava tubes, cracks, crevices and fissures; permeability is high. Groundwater passing through the porous volcanic lava discharges into the ocean all along the shoreline.



Mr. William M. Bass, Jr.
High Technology Dev. Corp.

CPO-745-85

Tenant operations in the fields proposed may use or generate toxic substances (materials, byproducts, products, wastes, or combination thereof). EIS Preparation Notice indicates that surface runoff would collect in ditches, discharging at a single point, and that each tenant would be responsible for disposal of its own liquid wastes. The forthcoming EIS, therefore, should discuss controls which will prevent contamination of coastal waters and marine resources.

In other respects, the proposed EIS appears to address both the potential environmental and economic impacts on land and in the adjacent ocean. Part IV highlights those areas that should be looked at in detail. The list of agencies to be consulted appears extensive and complete.

Very truly yours,

SUSUMU ONO, Chairperson
Board of Land and Natural Resources



STATE OF HAWAII
DEPARTMENT OF LAND AND NATURAL RESOURCES
P. O. BOX 421
HONOLULU HAWAII 96809

SUSUMI OHNO, CHAIRMAN
BOARD OF LAND AND NATURAL RESOURCES
EDGER A. MAMAKO
SECRETARY TO THE CHAIRMAN
DIVISIONS:
AGRICULTURE DEVELOPMENT
PROGRAM
AGRICULTURAL RESOURCES
CONSERVATION
RECREATION ENFORCEMENT
COMPTROLLER
FOREST AND WILDLIFE
LAND MANAGEMENT
STATE PARKS
WATER AND LAND DEVELOPMENT

REF. NO.: CPO-787-85

MAY 0 8 1985

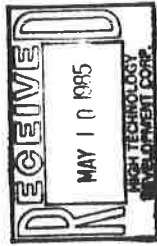

Mr. William M. Bass, Jr.
High Technology Development Corporation
Central Pacific Plaza, Suite 252
220 South King Street
Honolulu, Hawaii 96804

Dear Mr. Bass:

SUBJECT: Additional Comments on the Environmental Impact Statement Preparation Notice -- Development Plan for the Hawaii Ocean Science and Technology Park and Proposed Expansion of the Natural Energy Laboratory at Keahole, North Kona, Hawaii

This is a follow-up to our letter of April 30, 1985 on the subject Environmental Impact Statement prep notice. We neglected to include the following concerns regarding historic sites:

Identification and Location of Historic Sites

Both these project areas have received a 100% survey, and all historic sites have been located. In the HOST Park parcel, the notice states 45 sites have been identified (p. 16). We have recently reviewed this assessment in Land Use Commission Petition comments (Attachment 1). Our review of eight archaeological surveys in this parcel indicates only 44 sites are present. One was not identified in the recent reconnaissance. Two other sites are larger than documented in the reconnaissance.

In the NELH property, the notice states that an archaeological reconnaissance survey has identified 24 archaeological sites. This assessment is correct. (Note: If the existing NELH facilities have eliminated some of these sites the number of sites in this parcel should be revised, and we should be notified for our records).

Information in and Interpretation of These Sites

The notice does not review the extent of the research in the area nor the findings. It would be useful to briefly include this information in the EIS, for it helps understand site significance.

Mr. William M. Bass, Jr.
High Tech. Dev. Corp.

CPO-787-85

Site Significance

Site significance needs to be more clearly addressed in the notice.

Archaeological sites are nearly all significant for the information they contain on the past (areal and architectural measurements as well as artifacts and other contents in deposits). Some archaeological sites also merit preservation for such purposes as long-term scientific research value, public interpretive exhibits, etc.

All archaeologists who have worked in these parcels are in agreement that these sites are primarily significant for the information they contain on the prehistory and early history of this area. The notice correctly states this for the NELH area, but seems to imply that the sites in the HOST Park area have no such significance. This does not appear to be the case. Also, despite looting, much of this information is still present in these sites. Architectural remains still stand, and need to be fully documented at many sites, and archaeological excavations have shown that deposits with important information do exist in some sites.

There are sites in these parcels with some significance for preservation and exhibition. The Mamalahoa Trail is one such site, which the LUC Petition for the HOST Park noted. Also, Places with the recommendation that it be preserved as an example of early 1800s housing.

Impacts

The nature of the impacts to historic sites do not seem to be adequately discussed.

In the HOST Park parcel, the notice documents road grading, underground utility placement, a cold water pipe system and a header tank, a warm water pipe system with a pump station, a wastewater disposal area, a restroom/parking facility, and some work preparing tenant sites (p. 8-9). The notice only considers impacts on historic sites from the restroom/parking facility. The likelihood that some of the other project components will damage historic sites seems high because historic sites are scattered about the parcel -- not only in the coastal areas, but inland. This likelihood is not discussed.

A

In the NELH parcel, the notice does not specify what impacts will occur to historic sites when the future extensions occur. Some idea of impacts of the extension need to be specified.

Mitigation Plans to Avoid/Reduce Impacts to Historic Sites

Mitigation plans do not seem to be adequate, particularly in light of potentially greater impacts.

In the HOST Park parcel, the notice only proposes to move the restroom/parking facility to avoid sites that need preservation (p. 21). There are many sites in the planned restroom area, and movement of the facility to avoid impacts may not be an easy task. No plans to reduce impacts caused by the other development components in this parcel are considered. (Note: The LUC Petition for this parcel included avoidance plans and preservation of the Mamalahoa Trail. There is a conflict between these two documents).

In the NELH parcel, it is proposed only to "consider the presence of historic sites when allocating areas for particular land use or facilities" (p. 21). This is not a specific enough plan to ensure protection of the sites in this area.

Historic Sites Section Recommendations

We recommend that:

1. The section of the EIS which will describe Historical/Archaeological Resources under "Description of the Environmental Setting" be revised. Specifically,
 - a. The discussion of sites in the HOST Park parcel should include a revised site location map and an accurate count of historic sites. We have attached a draft revised site location map (Attachment 2).
 - b. Brief information on the extent of previous work and the nature of current findings be included. We have attached a discussion which can serve as an example (Attachment 3).
 - c. The discussion of site significance needs revision. Sites significant for their information content and sites significant for preservation need to be discussed. (Our discussion above under Site Significance can serve as an example.)

2. The section of the EIS on "Some Potential Environmental Impacts" which considers impacts on Historical/Archaeological Sites should be revised. Specifically, the following need to be included:
 - a. An evaluation of the impacts of all project components in the HOST Park (either individually or collectively).
 - b. An evaluation of the probable nature of impacts in future extension phases in the NELH parcel.

3. The section of the EIS under "Mitigating Measures" for impacts on Historical/Archaeological Sites should be redone in relation to the revised discussion of impacts. We would recommend that the mitigation measures include an agreement to have archaeological data recovery work done before construction and to preserve a few sites, and that these actions be undertaken in consultation with our office.

- a. Data recovery work would not be a massive undertaking, for sites in these parcels are generally small and deposits are shallow. It should involve mapping, description and excavation at all sites still containing unrecorded or unrecovered significant information. (In the HOST Park parcel, we believe only 19 sites need additional detailed mapping and only seven will need controlled excavation of deposits. Needed work in the NELH parcel has not been specifically itemized, but the archaeological reconnaissance report on this area (Clark 1984) makes general recommendations).

- b. For sites preservation, we recommend the preservation of one site and four examples of other site types. The LUC Petition for the HOST Park provided a plan for the preservation of the historic period Mamalahoa Trail, and we concurred with this plan (Attachment 1) and still do. In our review for the LUC Petition, we also recommended four other sites be preserved as examples of Hawaiian adaptation to this environment -- 1918 (a historic period permanent dwelling site), 1919 (a prehistoric period permanent dwelling site), 1917.5 (a prehistoric period temporary-use shelter), and one C-shape (a prehistoric period temporary-use shelter) of the petitioner's choice. This Preparation

GEORGE R. ARITOSHII
GOVERNOR OF HAWAII

Attachment
1



SUSUMU ONO, CHAIRMAN
BOARD OF LAND & NATURAL RESOURCES
EDGAR A. HAMAHA
DEPUTY TO THE CHAIRMAN
DIVISIONS:
ADVANCE TIME DEVELOPMENT
AGRICULTURE
CIVIL ENGINEERING AND
CONSTRUCTION
CONSERVATION AND
RECREATION
FORESTRY AND WILDLIFE
LAND MANAGEMENT
STATE PARKS
WATER AND LAND DEVELOPMENT

Mr. William M. Bass, Jr.
High Tech. Dev. Corp.
CPD-787-85

Notice indicates both the HOST Park and the NELH parcels are one development package. The NELH parcel also contains examples of the above four site types. Rather than confine preservation to one parcel's sites, we propose that the developing agency select one excellent example of each type from either parcel for preservation, in consultation with our office. Sites are small and preservation should not hinder development.

This proposed mitigation plan will remove any adverse impacts to historic sites in the parcels. It will also benefit development by removing concerns about project realignments related to historic sites and about procedural delays associated with such realignments. It will also benefit the public by recovering and preserving valuable information from the historic sites in this area. And it will be beneficial in preserving a few sites as examples of former Hawaiian life in this area, a life oriented to marine exploitation and thus compatible with this development's theme.

We apologize for any inconvenience we may have caused by our untimely response. Rest assured that our comments on the Draft EIS will be submitted in a timely fashion.

Should you have any questions regarding this matter, please feel free to contact our Planning Office staff at 548-7837.

Very truly yours,

Susumu Ono
SUSUMU ONO, Chairperson
Board of Land and Natural Resources

STATE OF HAWAII
DEPARTMENT OF LAND AND NATURAL RESOURCES
DIVISION OF STATE PARKS
P. O. BOX 421
HONOLULU, HAWAII 96809

April 10, 1985

MEMORANDUM

TO: Gordon Soh, Planning Office

FROM: Raiston H. Wagata, State Parks Administrator

SUBJECT: LUC Petition 885-592, Conservation to Urban Keahole Hawaii Ocean Science & Technology Park Oases 1 & 2 and Kalaooa 5, North Kona, Hawaii
TRK: 7-3-09:05, 7-3-43:03

Thank you for the opportunity to comment on this petition.

Identification & Location of Historic Sites

The petition notes that an archaeological reconnaissance survey identified 45 sites. (The survey report, Barre 1985, is appended as Exhibit 7 in the petition.) A brief reference is made to the fact that other archaeological surveys had occurred within the project borders (p. 20), and the archaeological reconnaissance report lists 4 such studies (Ching, Cluff and Riley 1968-69; Rosendahl and Kirch 1975; Rogers-Jourdane 1978; Rosendahl 1978). However, sites found in these prior projects are not evaluated. Also, four other important studies are not noted at all -- 1973-74 State DLNR survey (State of Hawaii, Historic Sites Inventory), 1975 survey and excavation by Cordy (1978, 1981), the final report of 1978 survey and excavation work (Rosendahl 1980). These projects all occurred within the coastal zone of the project area.

Our review of the archaeological reports indicates that 43 sites are within the project border -- T-40 and T-41 are one site (Hawaii State Historic Site 10-27-1917; Bishop Museum site D15-20), and T-34 is site 10-27-1920 (D15-11) located within the MELH parcel and not within this project's borders (Clark 1984). An additional site (10-27-1918; D15-9), a large historic house compound, should also be in the project area. For it was located at the junction of the coastal trail and the old jeep road running inland through Kalaooa-Ooaa. Two of these sites are on the Hawaii Register of Historic Places -- 1917 (T-40 & T-41) and 1918.

One problem in identifying sites is that different site numbers were given in past studies. Clark (1984) resolved this problem for the MELH project area. Our staff has coordinated the site numbers within the current project area for this review, and this information is available at our office.

Memorandum
April 10, 1985
Page Three

These facilities are to be moved to avoid conflicts with historic sites (p. 20, 24). In the inland zones of the property, road cul-de-sacs and utilities in road corridors will be present (p. 7 of Exhibit 8) and presumably the buildings. No provision for historic sites in this area are noted. The petition does state, however, that "HDC and future tenants will make every effort to preserve sites worthy of preservation and will excavate and document all others" (p. 29, see also p. 24).

Historic Sites Section Recommendations

The bulk of the sites in the project area are important solely for their information content. Movement of planned facilities to avoid these sites is certainly acceptable; but it would be difficult to monitor during the future growth of this area, and despite the best of intentions, adverse effects to sites could occur. Also, such avoidance actions might prove to take time procedurally and thus be inconvenient to the developer. Further, looting has occurred in some sites, and this might increase with greater public access. Given these factors, we recommend that it would be best to conduct an archaeological intensive survey and salvage program before development, to recover the remaining important information from these sites. Much of this information has already been recovered. We believe only 19 sites will need additional detailed mapping and measurement, and many are small, single-structure sites. And we believe only 7 sites will need controlled excavation of deposits. (See attachment for recommendations as to the specific sites) These sites are quite shallow. The excavations should not cost a great deal, and it would eliminate any future concerns about adverse impacts on these historic sites.

We further recommend the preservation of 5 sites. We concur with the petitioner's plans for the preservation of the Mamalahoa Trail -- certainly the most significant site for exhibition value. We also recommend sites 1918 (a historic permanent dwelling site), 1919 (a prehistoric permanent dwelling site), 1917's cave (a cave shelter), and one C-shaped shelter site of the petitioner's choice be preserved. They are small sites which can serve as examples of Hawaiian adaptation to this harsh environment.

Should you have any further questions, please feel free to contact Dr. Ross Cordy, Staff Archaeologist, at 548-7460.

/s/ RALSTON H. WAGATA

Ralston H. Wagata

Memorandum
April 10, 1985
Page Two

Site Size

Our review also indicates that two sites are slightly larger than documented in the archaeological reconnaissance. T-36 is only part of 10-27-1919 (D15-10) which also included a platform on the ocean side of the old jeep road and a cairn. T-33 seems to be but a part of 10-27-5602 (Rosendahl 1980:70-73) which also included a petroglyph, papamu game, grinding stone, and cave shelter.

Information In and Interpretation of the Sites

The earlier work included intensive survey at sites 1917, 1918, 1919, 5602, 5603, 5604, and 5605 (State Inventory; Cordy 1978; Rosendahl 1980) and excavations occurred at 1917 (Cordy 1978; Rosendahl 1980), 1919 (Cordy 1978), and 5602 and 5603 (Rosendahl 1980). Dates from these sites range from the late A.D. 1500s into the 1800s.

Initial interpretations for these findings indicate 1 permanent dwelling and numerous temporary habitation shelters in prehistoric times, and 1 permanent dwelling and some shelters in the 1800s. The bulk of these sites are clustered on the coast.

Site Significance

All previous archaeologists are in agreement that these sites are primarily significant for the information they contain on the prehistory and early history of this area. Despite looting, much of this information is still present in these sites, contrary to the petitioner's statement (p. 20).

The Mamalahoa Trail is of significance for exhibition. And site 10-27-1918 on the Hawaii Register of Historic Places has been recommended for preservation as an example of early 1800s housing.

Impacts & Plans in the Petition

The petition notes that the Mamalahoa Trail is to largely be preserved in an easement within the project area, only being crossed by a few driveways and utility lines (p. 20, 29).

As for the other sites, the petition notes most lie in the coastal zone of the property, which will be retained for public use with only a small parking/restroom facility and possibly a visitor's center in this zone (p. 20, 24; Exhibit 8, p. 7).

ATTACHMENT 2

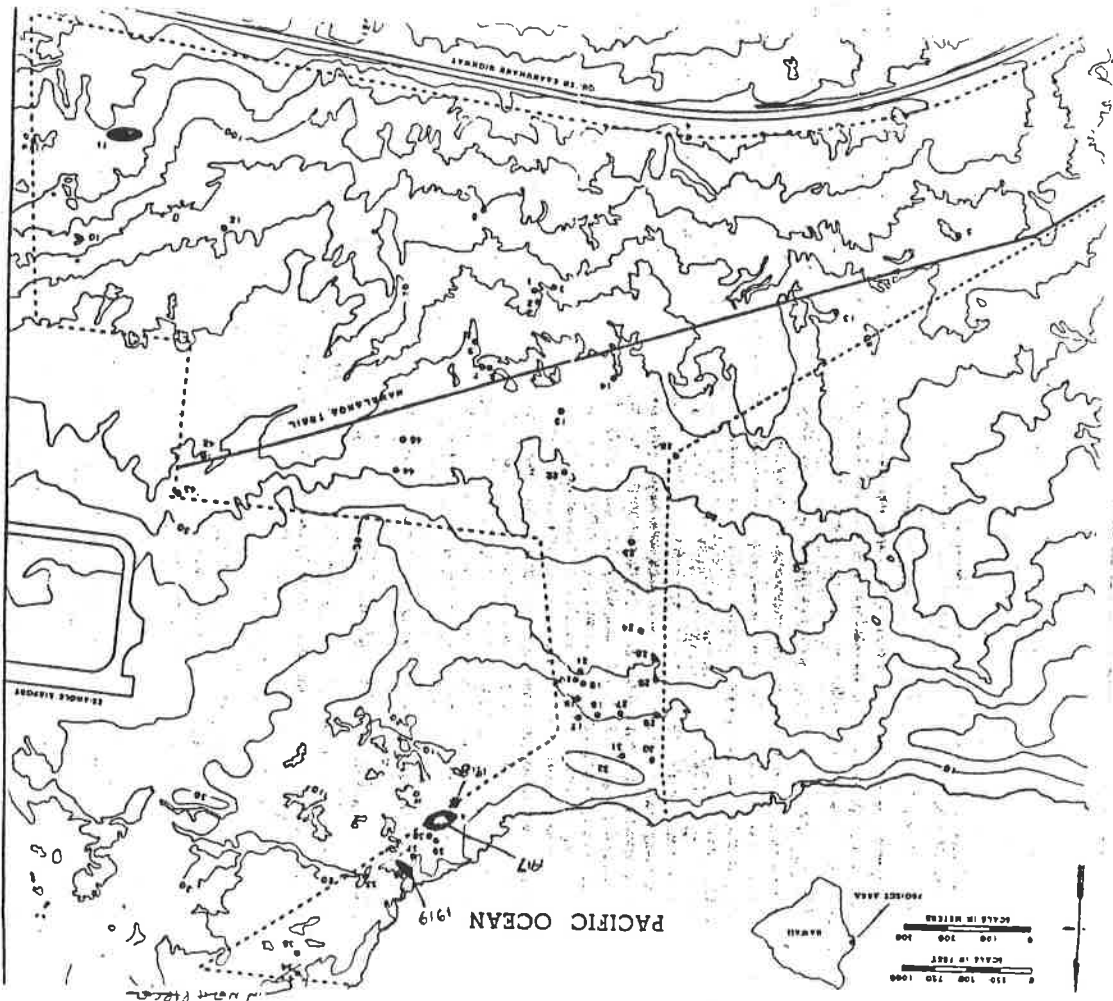

NOTE: ALL OF SARAWAKA (1985)'S SITES NOW HAVE
 RE-ASSIGNED SITE NUMBERS. PLEASE CONSULT
 THE PUBLIC WORKS OFFICE FOR MORE INFORMATION.

ATTACHMENT 3

Information in and Interpretation of these Sites

8 prior archaeological surveys have been done in the HOST Park parcel, and 7 have been done in the NGLH parcel. These surveys include intensive surveys and excavations.

Nearly all sites fitting permanent housing criteria along the coast have been carefully mapped, minimally excavated, and minimally dated. Deposits are generally shallow and limited in area. Smaller sites have been mapped in detail, excavated and dated only along the NGLH access road. Again, deposits were generally shallow and limited. Most smaller sites such as those located in the HOST Park archaeological reconnaissance survey have not been mapped in detail, nor have they been excavated in cases where deposits are present.

Current interpretations indicate that this area was settled in the A.D. 1400s. It had a small population prehistorically and an even smaller population in early historic times. A few permanent dwellings were along the shore with numerous temporary habitations (e.g., shelter caves and C-shaped shelters) just behind or along the shore. Trails led inland across the barren pahoehoe flows to the agricultural fields situated at about the 800-2200 foot elevations. Along these trails, there were shelters (caves, C-shaped enclosures, etc.) and cairns, the latter apparently marking the trails and shelters. Major trails crossing through these lands parallel to the shore were the prehistoric/historic coastal trail (the 20th Century jeep trail) and the historic period Mamalahoa Trail.

The HOST Park and NGLH parcels contain archaeological sites along the coast and lower barren pahoehoe areas.

7



HIGH TECHNOLOGY DEVELOPMENT CORPORATION

Central Office, Plaza 220 South King Street, Suite 252
Honolulu (808) 548-6600

Mailing Address: P.O. Box 2359, Honolulu, Hawaii 96804

GEORGE R. ARYOSHI
PRESIDENT
K. TIM YEE
CHAIRMAN

WILLIAM M. BASS, JR.
EXECUTIVE DIRECTOR

June 21, 1985

The Honorable Susumu Ono, Chairperson
Board of Land and Natural Resources
Department of Land and Natural Resources
P.O. Box 621
Honolulu, Hawaii 96809

Dear Mr. Ono:

Subject: Environmental Impact Statement Preparation Notice--
Development Plan for the Hawaii Ocean Science &
Technology Park and Proposed Expansion of the Natural
Energy Laboratory of Hawaii at Keahole, North Kona,
Hawaii

Thank you for your comments on the subject notice of
preparation. In answer to the concerns expressed in your
letter of April 30, 1985:

1. The information that you specified will be included in the
draft EIS.
2. The draft EIS will discuss controls which will prevent
contamination of coastal waters and marine resources.

We also appreciate your additional comments on Historic Sites
as outlined in your letter of May 8, 1985. Your suggestions
will be incorporated into the draft EIS. Archaeological
mitigation will be incorporated into the detailed planning and
construction contracts for HOST Park and will be addressed for
NELH in the draft EIS.

We look forward to your comments on the draft EIS.

Sincerely,



William M. Bass, Jr.
Executive Director



HIGH TECHNOLOGY DEVELOPMENT CORPORATION

Central Pacific Plaza, 220 South King Street, Suite 252
Honolulu, Hawaii 96804
Telephone: (808) 548-8906

Mr. William M. Bass, Jr.

Page 2

April 26, 1985

- On p. 8, the document should state that the existing ocean corridor is one mile long.
- The title of the listing of projects on p. 10 should be reconsidered as it is not clear whether the (IMMUND) project is considered a commercial project.
- Page 20, item E, should explain that wastewater will be injected onshore to a depth that will be great enough to ensure that discharge will reach the ocean offshore at a distance and depth that will not affect the water quality of nearshore waters.

In conclusion, the proposed uses, probable impacts and mitigating measures must be clearly defined and discussed and a phasing plan must be formulated based on market demand and available funding. These elements must be coordinated by a management plan to insure that the goals and objectives of the Hawaii Ocean Science and Technology park are realized.

Thank you for the opportunity to comment.

cc: Ms. Marilyn C. Metz,
The Traverse Group, Inc.
Office of Environmental Quality Control

June 21, 1985

Mailing Address P.O. Box 2359 Honolulu Hawaii 96804

GEORGE R. ARYOSHA
GOVERNOR
K. TIM YEE
CHAIRMAN
WILLIAM M. BASS, JR.
PRESIDENT

The Honorable Kent M. Keith
Director
Department of Planning and
Economic Development
250 South King Street
Honolulu, Hawaii 96804

Dear Kent:

Subject: Environmental Impact Statement Preparation Notice--
Development Plan for the Hawaii Ocean Science &
Technology Park and Proposed Expansion of the Natural
Energy Laboratory of Hawaii at Keahole, North Kona,
Hawaii

Thank you for your comments on the subject notice of preparation. In answer to your general concerns:

1. The EIS will assess and evaluate three potential development scenarios for HOST Park and two scenarios for NELH. Within these scenarios, which will reflect "worst case" impacts for each development, potential activities will be described, their environmental impacts will be disclosed, and mitigating measures will be recommended. These mitigating measures will be incorporated into the conditions, covenants and restrictions (CC&R's) for the HOST Park and into future leases and facilities use agreements negotiated by NELH. In addition, performance standards and restrictions may be placed on the development as conditions for obtaining various other State, Federal and County permits will also become part of the CC&R's, leases and other development agreements. In the future, if new and different types of activities, not addressed within the scenarios, request permission to locate on either of the sites environmental assessments will be made and, if required, supplemental environmental impact statements will be filed.

2. The EIS will attempt to address the requirements of the various permitting agencies. It is recognized, however, that when specific elements of the plans are implemented, other

The Honorable Kent M. Keith
June 22, 1985
Page 2

concerns may arise. At that time, it is expected that the permits will include conditions and restrictions that will mitigate these additional concerns.

3. Alternative methods of ocean water disposal have been studied. These methods and their environmental effects will be addressed in detail in the draft EIS.

4. The draft EIS will identify the extent of the storm wave and tsunami hazards at NELH and recommend methods to diminish or avoid impacts due to flooding. It will also address concerns related to potable water, public access, security of facilities, recreational impacts and potential earthquake and seismic impacts.

Your specific comments will be incorporated into the draft EIS.

In summary, the proposed uses, probable impacts and mitigating measures will be clearly defined and discussed in the draft EIS within each development scenario. Where possible, probable phasing will be identified; at the least, in areas of specific concern (such as ocean water disposal) threshold values will be identified and monitoring programs will be outlined. A management plan will evolve from the EIS mitigating measures, the CCR's, and coordination between the NELH and HOST planning efforts.

We appreciate your interest in the project and look forward to your comments on the draft EIS.

Sincerely,

William M. Bass, Jr.
Executive Director



University of Hawaii at Manoa

Environmental Center
Crawford 317 • 2650 Campus Road
Honolulu, Hawaii 96822
Telephone (808) 948-7381

April 24, 1985

PN:0042

High Technology Development Corporation
Central Pacific Plaza, Suite 252
220 South King Street
Honolulu, Hawaii 96813

Attention: Mr. William M. Bass, Jr.

Dear Mr. Bass:

EIS Preparation Notice
Hawaii Ocean Science and Technology Park
and
Proposed Expansion of the Natural Energy Laboratory of Hawaii
Keahole, North Kona, Hawaii

The proposed "Development Plan for the Hawaii Ocean Science and Technology (HOST) Park and Proposed Expansion of the Natural Energy Laboratory of Hawaii" (NELH) project involves 869 acres of State-owned lands located within the conservation district and includes the commercial development of a high technology park (547 acres) and expansion of NELH (322 acres). NELH also utilizes approximately 121 acres of coastal waters and submerged lands off Keahole Point.

The Center does not normally review EIS-system documents at the Preparation Notice stage. However, our past involvement with the environmental analyses at NELH, lead us to comment at this stage. Our in-house review has been conducted with the assistance of the Environmental Center's staff members: Jacqueline Miller, Noreen Tashima, Julianne Mansur, and Eileen Anthony.

General Comments

In reviewing the Preparation Notice, we note that references are given to only secondary sources in support of a number of technical statements. For example, the EIS for NELH (no date given) (reference 12) is repeatedly cited as the supporting reference for climatic, or topographic statements. Whenever possible, we urge that the more original source for the particular topic be cited rather than a generalized informational document such as an EIS. As a matter of editorial style, we suggest citations in the text (author, year) rather than numbered references to a list at the end of the document. Text citation greatly facilitates reading the document, because one does not have to keep flipping back and forth to check on the basis for key statements.

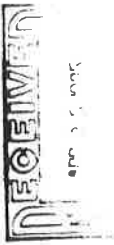

High Technology
Development Corporation

-2-

April 24, 1985

There are several places in the document where baseline data are provided for one site (usually NELH) but not for the other (most frequently, HOST). It is occasionally difficult for the reader to keep the two sites in mind. We recognize the need to consider both sites jointly, but the preparers of the DEIS may find it greatly to their advantage to continue with the dichotomous format provided under Part II-C with each of the topics cited in the "Table of Contents." When aspects of both sites must be considered together, they can be addressed in a separate section.

Our reviewers have identified the following more specific points that should be clarified or expanded in the Draft EIS.

Page i. Table of Contents

C. Master Plan for NELH

We suggest that another section titled "Ongoing Commercial Projects," be added. It appears that some of the "pending projects" may actually have been implemented at least to some level. In the interest of accuracy, it seems important to indicate the present status as well as future plans, at least to the extent known.

4.0 Ocean Water Supply

We call attention to the need to consider disposal systems for NELH similar to the consideration under C. Host Park Development Plan item 4.0.

C. Host Park Development Plan C. Master Plan for NELH

As presently formatted there are two 'C's under Part II, one applying to HOST and one for NELH. These would be better cited as C₁ and C₂ to facilitate references.

Page 4. Planning Considerations

The proposed development is adjacent to the Keahole Airport. Will noise be a problem in terms of restricting use of the park by any of the potential occupants?

Page 7, 8. Utilities

We note that each tenant of the HOST park will be responsible for his own sewage treatment disposal system. The potential effects of the disposal of the effluent will depend on the types and quantities of waste that will be disposed. In the light of the porosity of the ground and the need to maintain pristine nearshore conditions we would identify the effluent disposal as a matter of concern. The DEIS should address this issue and give some approximate figures as to what can be expected in terms of types and volumes of commercial, industrial, restaurant-tourist related wastes that can be accommodated by cesspools. If a private sewage treatment facility will be required then it would seem more cost efficient to have a centralized system.

Page 8. Archaeological Sites

The Preparation Notice states, "The Kings' Trail (also known as the Mamalahoa Trail), although not of great archaeological significance...." The source of this conclusion should be referenced in the DEIS.

Page 8. On-Site Improvements

Note our previous comments regarding sewage treatment concerns.

Page 8. Ocean Water Supply and Disposal Systems

Both the cold and warm water pipes will presumably be large in diameter (48"). Twenty-five foot wide utility easements are proposed to provide space for the pipes. We suggest that the pipes be buried to the maximum depth that can be economically justified so as to minimize the otherwise visual obstacle of a 48" pipe on the surface. A commitment to camouflage landscaping (bougainvillea?) of that portion of the pipe extending above ground level (assuming that not all 48" can be buried) should be affirmed in the development contract. We note that the service roads will be gravel. Will this present a dust problem either to operations at the HOST or NEUH parks or to activities on the adjacent properties (airport?).

Page 8. Warm Water Piping System

Wells in the site area are suggested as an alternative to a near-surface ocean intake for the supply of "warm" water. It may be found that the "warm" water from these wells can be supplied at lesser cost. However, without test well data, it is not possible to determine the water quality of the wellwater as compared with the water from an ocean intake. It is expected that both salinity and the temperature will depend on the well depth and well casing depth. If wellwater is used, both the salinity and temperature will be significant in determining both the use of the water as well as the effects of the discharge of any wastewater. (See also additional comments under Ocean Water Disposal and Ocean Water Quality, pp. 4-6.)

Page 8a. Figure 4

Page 9a. Figure 5

The location of the wastewater injection well area some 2000 feet directly inland from the location of the warm water supply (intake) system may create a potential contamination problem. Please note our discussion under Offshore Water Quality, pp. 5-6.

The ocean water disposal area lies parallel to the coast (Figure 5) and, combined with the cold water pipe on the maka side, would appear to present a physical barrier from the HOST park to the narrow strip of land connecting HOST to the shore. Establishing the disposal area perpendicular to the shore might facilitate use of that coastal-access strip.

Page 9. Ocean Water Disposal

This of course is the most significant issue of concern. We recognize that at this stage the specific quality of the discharge cannot be defined. We call your attention to the discussion we provide under Ocean Water Effluent Disposal and Offshore Water Quality, pp. 5-6. From the visual perspective, will the discharge pipes be buried?

Page 9. Figure 6

This figure is quite confusing. We suggest that it either be deleted or redrafted so that the airport facilities are easily differentiated from the NEUH and HOST areas.

Page 10, 11. Pending Commercial Projects

Since several of these projects are actually in operation, at least to some extent we suggest that this section be revised to more clearly distinguish the existing from the future conditions. For example, if a project is a well defined proposal or in operation then greater detail should be provided on the nature and operations of the facility that are to be covered by this EIS. If it is still in the planning stage, then it can be cited only briefly at this time. To the extent that the potential impacts of either a present or a future project can be fully disclosed in this EIS, no additional FIS on that project should be necessary. If, however, the potential impacts, (i.e. wastewater characteristics, volumes, species, operations, etc.) cannot be fully defined at this time, then an assessment should be required for this project, and possibly a supplemental EIS. (Also see Concluding Remarks, p. 7.)

Page 14. Climate

The prevailing tradewinds are northeast not northwest.

Page 15. Hazards

As shown by Cox (Tsunami Hazard at Ke-ahole Point, UH Environmental Center Special Rpt. 0028, 1982), the near-shore 100-year tsunami runup height estimate of 15 feet cited in the Preparation Notice is erroneous. The Corps of Engineers estimate, on which are based the inundation areas shown on the cited flood insurance rate maps, is 8.7 feet. Cox (1982) presented evidence suggesting a value of about 9.3 feet. Coastal flooding at Ke-ahole may result, however, from storm waves as well as tsunamis. We understand that the runup height and area of inundation resulting from the waves of Hurricane Iwa exceeded the estimates for the 100-year tsunami. The average recurrence interval of an event such as that hurricane is unfortunately, not known.

Page 15. Vegetation, Avi-Fauna

The reference cited implies that the vegetation and avi-fauna studies were confined to the NEUH site. Recognition of the vegetation and avi-fauna at the HOST site should also be provided.

Page 17. Chemical Oceanography

Where were the water samples collected on which the water chemistry characteristics were measured?

Page 18. Threatened and Endangered Species

Green sea turtles should be included in discussions of threatened and endangered species.

Page 18. Anchialine Ponds

Although it was cited that, "None of these ponds were considered by the investigators to be either exceptional or significant," in view of the extensive coastal development over the past 11 years particularly at the proposed Waikoloa Beach Resort project, the anchialine ponds at NELH and HOST may now be significant. We suggest that Richard Brock (UH Sea Grant) be consulted for a reevaluation of the significance of these ponds.

Page 19. Recreation Uses

The first two sentences seem to contradict each other or at least to require clarification. Due to the request for extensive changes in land-use classification and zoning (to more intensive classification), mitigative measures (e.g. public access to the coastline) should be discussed in the DEIS.

Page 9. Ocean Water Disposal
Page 20. Offshore Water Quality

It is proposed that the wastewater from projects in the area be discharged into injection wells. It is recognized, correctly, that the discharge by this means will not have an adverse effect on any freshwater resource. The statement is made, however, that "the waste water will be injected to a depth that will be great enough to ensure that the discharge will reach the ocean at distance and depths that will guarantee that the pristine water quality of the nearshore waters will not be degraded". This statement is based on the false premise that the depth at which the wastewater will reach the ocean will depend primarily on the depth of injection. The depth at which the wastewater will reach the ocean will actually depend primarily on the density of the wastewater and the gradient of density with depth in the groundwater.

Assume for example that the wastewater were to be injected at some depth between 100 and 300 feet below sea level and that, as is probable, the salt groundwater at that depth has a temperature and a salinity similar to that of seawater at that depth. Although the hydraulic conductivity of the lava-flow aquifer is probably greater in the plane of the lava flows than transverse to that plane, no consistent barriers to the movement of the groundwater away from the injection point in a direction normal to the plane of the lava flows can be expected.

On the one hand, if the wastewater were to have the temperature and salinity of the cold water desired from the deep offshore intake its density would be greater than that of the ambient groundwater and it would tend to sink upon injection. In this case, however, at least a part of the injected wastewater might well be transported inland in the salt-groundwater countercurrent beneath the Herzberg lens that must exist to supply to the lens the salt that makes it brackish.

On the other hand, if the wastewater were to have the temperature and salinity of the brackish water in the lens, its density would be less than that of the ambient groundwater, and it would tend to rise so as to meet with and flow seaward in the lens, being discharged near the shoreline.

Assuming, as seems probable that the wastewater will have a density intermediate between that of the brackish water of the lens and that of the ambient salt groundwater, it will still tend to rise toward the lens and still be discharged to the sea near the shore.

The plan to dispose of the wastewater by underground injection is undoubtedly proposed to avoid restrictions on direct disposal to the class AA coastal waters off Keahole. Although legal restrictions may well be circumvented by the plan, the quality of the wastewater and its effects on the quality of the near-shore coastal waters must nonetheless be of concern.

In the discussion of the impacts of the wastewater on the coastal water quality that is proposed in the final EIS, it should be assumed that the wastewater will reach the nearshore coastal waters unless it can be shown definitely that the density of the wastewater will be as great or greater than that of the ambient.

Page 19. Ocean Water Effluent Disposal

The statements, "The pool has proven to be an effective..." and "Monitoring has shown..." should be substantiated. For what discharge rates is this statement valid? For what concentrations of nutrients is this pond effective? What measures or actions will be taken if pollution is detected? Is there an estimate on the capacity of the pond in relation to the expected usage?

It is also stated that: "A 100,000 pound per annum..." Clearly, this "aquaculture exemption" will not apply in the near future. The following statement, "Hawaii's subtropical, warm ocean waters..." seems to be out of place.

Page 21. Economic Impacts

Since all of the eventual occupants of the NELH and HOST Parks are, we presume, not known at this time, meaningful economic assessment of cumulative impacts of the development of both parks on housing, schools and public facilities in the North Kona area may be all but impossible to prepare. If this is the case we suggest that consideration might be given to preparing a table of economic impacts assuming a broad range of scenarios in which volumes of intake water used, wastewater produced, personnel required (work force), and range of dollar value and volume of products produced might be the critical factors.

High Technology
Development Corporation

-7-

April 24, 1985

Concluding Remarks

We have above called attention to the need for preparing environmental assessments and even, possibly, the need for preparing supplemental EIS's, for projects whose nature is significantly different from or whose scope is significantly greater than the range of projects now existing, or planned. To satisfy the requirements for acceptance, the EIS now being prepared should include an explicit recognition of the above noted needs.

We wish to emphasize, however, that the existence and recognition of these needs will not diminish the value of the EIS now being prepared as an "umbrella" document. With its acceptance, the only supplementary documents needed in the case of most projects not now anticipated will be very simple assessments indicating that the environmental impacts of the projects will not differ significantly from those described in the "umbrella" document. A supplemental EIS will be needed for a project not now anticipated only if its environmental impacts will be significantly different from those described in the "umbrella" document.

We appreciate the opportunity to provide our comments at this preparation stage of the EIS and look forward to reviewing the draft EIS when it becomes available. If you have any questions regarding our comments, please don't hesitate to call.

Yours truly,



Doak C. Cox
Director

cc: OEQC
The Traverse Group, Inc.
Richard Brock
Jacquelin Miller
Noreen Tashima
Juliane Mansur
Eileen Anthony
Jack Huizingh



HIGH TECHNOLOGY DEVELOPMENT CORPORATION

Central Post Office Plaza, 250 South King Street, Suite 250
Honolulu, Hawaii 96813

Telephone (808) 548-8886

June 26, 1985

Dr. Doak C. Cox, Director
Environmental Center
University of Hawaii at Manoa
2550 Campus Road
Crawford 317
Honolulu, Hawaii 96822

Dear Dr. Cox:

Subject: Environmental Impact Statement Preparation Notice--
Development Plan for the Hawaii Ocean Science &
Technology Park and Proposed Expansion of the Natural
Energy Laboratory of Hawaii at Keahole, North Kona,
Hawaii

Thank you for your comments on the subject MOP. Original data
will be reported in the draft EIS. To respond to your specific
comments:

1. There was a typographical error in the MOP and Table of Contents, this will be corrected in the draft EIS. Development Scenarios for each facility, which will attempt to reflect "worst-case" scenarios, will be assessed in the draft EIS.
2. Potential occupants of MOST Park will be aware that they are located next to the airport. Covenants, Conditions and Restrictions for the Park will emphasize this and identify the need to mitigate noise problems for employees, as is done for airport employees.
3. At the present time, it is anticipated that septic tanks with leaching fields will be the recommended means of sewage disposal. Impacts of this on nearshore waters will be discussed in the draft EIS.
4. Archaeological sites will be discussed in detail in the draft EIS.

OFFICE OF ANCHORAGE
K. TIMMY L.
WILLIAM M. BLASS, JR.
1111 LITTLE HAWAII DRIVE

Mailing Address: P.O. Box 2370 Honolulu, Hawaii 96804

Mr. Doak C. Cox
June 26, 1985
Page 2

5. It is not definite, at this time, that 48" pipes will be constructed for the HOST Park. Visual impacts of pipes will be addressed in the draft EIS. Gravel roads should not present a dust problem in the area, however, this will be looked into in the continuing planning process and other recommendations may be made.
6. Should a decision be made to utilize brackish water wells rather than a warm water pipe, tests that you propose will be undertaken and the effects of the discharge will be monitored.
7. Studies of alternative methods and locations of sea water return flow disposal have been studied by Dames & Moore. These methods and the associated environmental impacts will be discussed in detail in the draft EIS.
8. As stated previously, it is the intent of the draft EIS to discuss "worst-case" scenarios and recommend means to monitor and control future conditions. In the event that a proposed project has unique characteristics that have not been anticipated in the EIS, an environmental assessment will be made and, if required, a supplemental EIS will be prepared. This will be determined by the Office of Environmental Quality Control (OEQC) as representative of the accepting authority, the Governor.
9. We will correct that typographical error concerning the treadwind direction.
10. Flood maps have been obtained from the Army Corps of Engineers for the MELH site. These maps include recent events. Wave and flood hazards will be discussed in the draft EIS.
11. Your comment on vegetation and avi-fauna has been noted.
12. Chemical and physical oceanography will be expanded on in the draft EIS.
13. A discussion of green sea turtles will be included in the draft EIS.
14. Anchialine ponds will be discussed in the draft EIS. We have been unable to locate the ponds on the HOST property although a couple of them have been found on airport property. The Army Corps of Engineers has agreed to make a site survey to verify the presence (or absence) of the ponds.

Mr. Doak C. Cox
June 26, 1985
Page 3

15. Recreation uses and public access will be discussed in the draft EIS.
 16. Economic impacts will be discussed in context of the development scenarios.
- As stated previously, if projects are proposed that would have significantly different impacts than those assessed in the development scenarios an environmental assessment will be made and a determination requested from OEQC as to whether or not a supplemental EIS is required.
- We look forward to your comments on the draft EIS. If you have any further concerns please contact Ms. Marilyn Metz of The Traverse Group, Inc., at 732-7143.

Very truly yours,

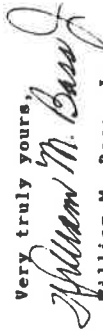
William M. Bass, Jr.
Executive Director



University of Hawaii at Manoa

Water Resources Research Center
Holmes Hall 203 • 2540 Dole Street
Honolulu, Hawaii 96822

8 May 1985

Mr. William M. Bass, Jr.
High Technology Development Corporation
Central Pacific Plaza, Suite 252
220 South King Street
Honolulu, Hawaii 96813

Dear Mr. Bass:

SUBJECT: Environmental Impact Statement Preparation Notice -
Development Plan for the Hawaii Ocean Science and
Technology Park and Proposed Expansion of the Natural
Energy Laboratory of Hawaii at Keahole, North Kona,
Hawaii, March 1985

We have reviewed the EISPN and have no comment to offer. Thank you
for the opportunity to comment. This material was reviewed by WRRRC
personnel.

Sincerely,

Edwin T. Murabayashi
Edwin T. Murabayashi
EIS Coordinator

ETM:jm



**HOUSE OF REPRESENTATIVES
THE THIRTEENTH LEGISLATURE**

STATE OF HAWAII
STATE CAPITOL
HONOLULU, HAWAII 96813

HENRY HAWAII PUBLIC WORKS
MARSHALL K. BEE
220 S. KING STREET
HONOLULU, HAWAII 96813

DIRECTOR OF REPRESENTATIVES

- 101 ANNE H. CLARK
- 102 HAROLD A. HARRIS
- 103 WYANDER W. HARRIS
- 104 DWIGHT L. HARRIS
- 105 ALBERTA HARRIS
- 106 BOBBI L. HARRIS
- 107 MARY L. HARRIS
- 108 HENRIETTA HARRIS
- 109 JOSEPH HARRIS
- 110 JAMES HARRIS
- 111 DONALD HARRIS
- 112 ROBERT HARRIS
- 113 JAMES HARRIS
- 114 JAMES HARRIS
- 115 JAMES HARRIS
- 116 JAMES HARRIS
- 117 JAMES HARRIS
- 118 JAMES HARRIS
- 119 JAMES HARRIS
- 120 JAMES HARRIS
- 121 JAMES HARRIS
- 122 JAMES HARRIS
- 123 JAMES HARRIS
- 124 JAMES HARRIS
- 125 JAMES HARRIS
- 126 JAMES HARRIS
- 127 JAMES HARRIS
- 128 JAMES HARRIS
- 129 JAMES HARRIS
- 130 JAMES HARRIS
- 131 JAMES HARRIS
- 132 JAMES HARRIS
- 133 JAMES HARRIS
- 134 JAMES HARRIS
- 135 JAMES HARRIS
- 136 JAMES HARRIS
- 137 JAMES HARRIS
- 138 JAMES HARRIS
- 139 JAMES HARRIS
- 140 JAMES HARRIS
- 141 JAMES HARRIS
- 142 JAMES HARRIS
- 143 JAMES HARRIS
- 144 JAMES HARRIS
- 145 JAMES HARRIS
- 146 JAMES HARRIS
- 147 JAMES HARRIS
- 148 JAMES HARRIS
- 149 JAMES HARRIS
- 150 JAMES HARRIS
- 151 JAMES HARRIS
- 152 JAMES HARRIS
- 153 JAMES HARRIS
- 154 JAMES HARRIS
- 155 JAMES HARRIS
- 156 JAMES HARRIS
- 157 JAMES HARRIS
- 158 JAMES HARRIS
- 159 JAMES HARRIS
- 160 JAMES HARRIS
- 161 JAMES HARRIS
- 162 JAMES HARRIS
- 163 JAMES HARRIS
- 164 JAMES HARRIS
- 165 JAMES HARRIS
- 166 JAMES HARRIS
- 167 JAMES HARRIS
- 168 JAMES HARRIS
- 169 JAMES HARRIS
- 170 JAMES HARRIS
- 171 JAMES HARRIS
- 172 JAMES HARRIS
- 173 JAMES HARRIS
- 174 JAMES HARRIS
- 175 JAMES HARRIS
- 176 JAMES HARRIS
- 177 JAMES HARRIS
- 178 JAMES HARRIS
- 179 JAMES HARRIS
- 180 JAMES HARRIS
- 181 JAMES HARRIS
- 182 JAMES HARRIS
- 183 JAMES HARRIS
- 184 JAMES HARRIS
- 185 JAMES HARRIS
- 186 JAMES HARRIS
- 187 JAMES HARRIS
- 188 JAMES HARRIS
- 189 JAMES HARRIS
- 190 JAMES HARRIS
- 191 JAMES HARRIS
- 192 JAMES HARRIS
- 193 JAMES HARRIS
- 194 JAMES HARRIS
- 195 JAMES HARRIS
- 196 JAMES HARRIS
- 197 JAMES HARRIS
- 198 JAMES HARRIS
- 199 JAMES HARRIS
- 200 JAMES HARRIS

March 27, 1985

Attn: Mr. William Bass, Jr.
High Technology Development Corp.
Central Pacific Plaza, Ste. 252
220 S. King Street
Honolulu, HI 96813

Re: Notice of Preparation, EIS - Hawaii Ocean
Science & Technology Park (HOST) at NEFH.

Gentlemen:

I have read your Notice of Preparation of the
EIS and wish to make the following comments:

1) There needs to be concern about future
expansion of the HOST Park and the fact that the
land south and makai is privately owned. Therefore,
there is no possibility of future expansion to the
south and with the Keahole Airport to the north,
this problem needs to be addressed. Should the State
start in earnest to negotiate for acquisition of this
privately-owned land? (See letter to Sus Ono, enclosed.)

2) The County of Hawaii appears to be planning a
sewage outfall in the Keahole area. This needs to be
addressed and determine what effects, if any, the
sewage outfall would have on the cold water pipe
nutrients and pristine character and the fact that the
EIS states that the "protection of the physical and
chemical water quality of the cold water and surface
water resources was a major consideration in preparing
the HOST Park Master Plan. The potential continued
success of both the HOST Park and NEFH is dependant
upon maintaining the high quality of source water".
(See copy of letters enclosed.)

3) There needs to be addressed the potential
problem of the injection wells at the 70' level "which
will drop the ocean wastewater to a depth that will
insure discharge at a distance greater than 1000'
offshore". What effect will this have on the warm
water that will be piped on to the shore for warm water
aquaculture and what effects will this have on the
"pathogen-free" water?

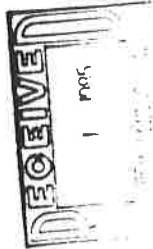

High Technology Development Corp.
March 27, 1985
Page 2

The EIS Notice of Preparation states that the water from the
injection wells will be discharged 1000' offshore but does not
say at what depth. Since the ground is very porous it will not
act as a strainer to remove wastes from experiments done with
the cold water affluent. What will the effect be of this
wastewater on the ocean near NEFH and what will be the turbidity
of that water as it enters near shore? The 1000' mentioned is really
not very far offshore. Perhaps we need to look at using the
wastewater in more diverse methods and experiments as well as
future commercial ventures before putting into injection wells.

Thank you for the opportunity to comment on this EIS prepa-
ration.

Yours very truly,
Virginia Isbell
Virginia Isbell
State Representative

EVR:ek

cc: Senator Richard Henderson
Representative Peter Apo, Chrm., House Ocean &
Marine Resources Committee
Mr. Jack Huizingh, Exec. Director, NEFH
Dr. Patrick Takahashi, Director,
Hawaii Natural Energy Institute, UH
Mr. Kent Keith, Director, DPED

Enclosures

Speaker
HENRY HAAI HHO PETER
Vice Speaker
MARSHAL L. ICE
Majority Leader
RICHARD A. KAWAKAMI
Minority Floor Leader
TON OKA-NOHA

DISTRICT REPRESENTATIVES

- 1st -- ANDREW TILVIN
- 2nd -- HARVEY S. TAJIRI
- 3rd -- WAYNE MITCHELL
- 4th -- DWIGHT Y. TAKAMINE
- 5th -- VIRGINIA ISBELL
- 6th -- ROBERT K. LINDSEY
- 7th -- MARK J. ANDREWS
- 8th -- HERRERT J. HONDA
- 9th -- JOSEPH M. SOUKI
- 10th -- BILL PFEIL
- 11th -- DANIEL KIHANO
- 12th -- RON MEMOR
- 13th -- ROBERT RUEDA
- 14th -- JOSEPH P. LEONG
- 15th -- BOB NAKATA
- 16th -- TERRANCE W. H. TOM
- 17th -- MARSHAL L. ICE
- 18th -- WHITNEY T. ANDERSON
- 19th -- JOHN JUSTIN MEEDEKOS
- 20th -- CAM CAVASSO
- 21st -- DONNA R. KETDAI
- 22nd -- HEAL JONES
- 23rd -- BARBARA MARUMOTO
- 24th -- FRID W. MARINGS, JR.
- 25th -- CALVIN K. Y. SAY
- 26th -- KEN KITAHU
- 27th -- BRIAN T. TANIGUCHI
- 28th -- JAMES T. SHON
- 29th -- DAVID M. HACHINO
- 30th -- KINAJI BROYD KAMALU
- 31st -- RUSSELL BLAIR
- 32nd -- MAZIE HIRUNO
- 33rd -- ROD TAM
- 34th -- MIKE LIU
- 35th -- GALEN K. OSOUIE
- 36th -- DINGHTI. YOSHIMURA
- 37th -- DENNIS M. NAKASATO
- 38th -- REYNALDO GRAJILTY
- 39th -- ROMY M. CACHOLA
- 40th -- DONNA MERCADO KIM
- 41st -- TOM OKAMURA
- 42nd -- CLARICE Y. HASHIMOTO
- 43rd -- ARNOLD MORGADO, JR.
- 44th -- FLOISE YAMASHITA TINGPALAN
- 45th -- MITSUO "MITS" SHITO
- 46th -- PAUL T. OSHIRO
- 47th -- MIKE CROZIER
- 48th -- HENRY HAALILUO PETERS
- 49th -- PETER K. APO
- 50th -- ALFRED C. IARDIZABAL
- 51st -- RICHARD A. KAWAKAMI

HOUSE OF REPRESENTATIVES
THE THIRTEENTH LEGISLATURE

STATE OF HAWAII
STATE CAPITOL
HONOLULU, HAWAII 96813

March 25, 1985

Mr. Susumu Ono
Chairman
Dept. of Land & Natural Resources
Kalanimoku Bldg.
1151 Punchbowl Street
Honolulu, HI 96813

Re: Hawaii Ocean Science Technology Park
at NEBH, Keahole, North Kona.

Dear Mr. Ono:

I have read the Notice of Preparation of EIS prepared for HOST Park. On page 4 (b), figure 2 of the Tax Map Key, I noticed that the HOST Park is in a very tenuous position. On one side is the Keahole Airport and on the other side makai, is private land. It would appear that there is no possibility of future expansion of the HOST Park unless the land makai is acquired by the State of Hawaii.

I personally feel that the High Technology Park is going to be very active and that there's going to be a need for more land along the coast, for expansion, including additional cold water pipes.

I would appreciate it very much, if you would comment on my concerns of future expansion and whether or not the State should now begin to look at acquiring by purchase, condemnation, or exchange the privately-owned land adjacent to the HOST Park.

I look forward to your early response.

Sincerely yours,

Virginia Isbell
State Representative

EVR:ek

cc: Rep. Peter Apo
Senator Richard Henderson
Mr. Kent Keith, Director, DRED



MAR 04 1985

DANTE K. CARPENTER
MAYOR



February 25, 1985

HONORABLE VIRGINIA ISBELL
STATE REPRESENTATIVE
HOUSE OF REPRESENTATIVES
STATE CAPITOL
HONOLULU HI 96813

SUBJECT: KONA SEWERAGE SYSTEM (NORTHERN ZONE)

We thank you for your letter of February 6, 1985, expressing concerns and suggestions on the means of effluent disposal for the proposed Kona Sewerage Systems.

The Northern Zone studies thoroughly considered the environmental and economic concerns in the development of the facilities plan. Aerated lagoons are recommended as the preferred method of treatment with deep ocean outfall as the preferred means of effluent disposal. The studies also considered alternatives such as injection wells and irrigation/reuse of wastewater. Also included in the study was a sludge disposal by means of landfill and reuse as agricultural fertilizer in land treatment application. While the studies have shown that the ultimate and economically effective solution for effluent disposal is the ocean outfall, provisions will be incorporated for diversion of the effluent to land reclamation projects as they become available.

We hope we have given you an overview in responding to your concerns.

DANTE K. CARPENTER
Mayor

Speaker
HENRY HAALILIO PETERS
Vice Speaker
MARSHALL K. IGE
Members
RICHARD A. KAWAKAMI
Mildred Fine Leader
TOMI OKAMURA

DISTRICT REPRESENTATIVES

1st -- ANDREW LEVIN
2nd -- HARVEY S. TAPRI
3rd -- WAYNE METCALF
4th -- DWIGHT Y. TAKAMINE
5th -- VIRGINIA ISRELL
6th -- ROBERT K. LINDSEY
7th -- MARK J. ANDREWS
8th -- HERBERT J. HONDA
9th -- JOSEPH M. SOUKI
10th -- BILL PFELT
11th -- DANIEL J. KIHANO
12th -- RON MENOR
13th -- ROBERT RINDA
14th -- JOSEPH P. IICONG
15th -- ROR NAKATA
16th -- TERRANCE W. H. TOM
17th -- MARSHALL K. IGE
18th -- WHITNEY T. ANDERSON
19th -- JOHN JUSTIN MEDeiros
20th -- CAM CAVASSO
21st -- DONNA R. IKEDAII
22nd -- HAL JONES
23rd -- MARIARA MARUMOTOI
24th -- FRED HERRING, JR.
25th -- CALVIN K. Y. SAY
26th -- KIN KIYABU
27th -- BRIAN T. TANIGUCHI
28th -- JAMES T. SHION
29th -- DAVID M. HAGINO
30th -- KINA'U ROYD KAMAI'I I
31st -- RUSSELL BLAIR
32nd -- MAZIE HIRONO
33rd -- ROD TAM
34th -- MIKE LUI
35th -- GALEN K. ONOUE
36th -- DWIGHT L. YOSHIMURA
37th -- DENNIS M. NAKASATO
38th -- RYUNALDO GRAULTY
39th -- ROMY M. CACHOLA
40th -- DONNA MERCADO KIM
41st -- TOM OKAMURA
42nd -- CLARICE Y. HASHIMOTO
43rd -- ARNOLD MORGADO, JR.
44th -- FLORES YAMASHITA TUNGIPALAN
45th -- MITSUO "MITSU" SHIHO
46th -- PAUL T. OSHIRO
47th -- MIKE CROZIER
48th -- HENRY HAALILIO PETERS
49th -- PETER K. AYO
50th -- ALI H. G. I. ARIZABAI
51st -- RICHARD A. KAWAKAMI

Minority Leader
MILTONI T. T. T. T.

HOUSE OF REPRESENTATIVES
THE THIRTEENTH LEGISLATURE

STATE OF HAWAII
STATE CAPITOL
HONOLULU, HAWAII 96813
March 15, 1985

Honorable Dante Carpenter
Mayor of County of Hawaii
25 Aupuni Street
Hilo, Hawaii 96720

Re: Kona Sewerage System (Northern Zone)

Dear Mayor Carpenter:

Thank you very much for your letter of February 25, 1985 regarding my concerns on the disposal of effluent for the proposed Kona Sewerage System.

Would you please send me a copy of the study you referred to and those pages which recommend aerated lagoons with deep ocean outfall as a preferred means of effluent disposal. I find it difficult to understand how a study could suggest an ocean outfall when we are so short of water and have a lack of development because of it. This also in view of the fact that several of the hotels use sewage-treated effluent for use on the golf courses and for irrigation purposes.

You suggested that the ultimate economically effective solution for effluent disposal is ocean outfall--but I really question whether it is truly economically effective when it may have a detrimental effect on shoreline aquaculture and the ocean thermal energy conversion deep-water pipe which is used for many experiments at NELH near Keahole, and when water is at such a premium in West Hawaii.

I would appreciate any information you can give me which will help me to understand how disposal of water in the ocean is preferable to its use on land.

With warmest personal regards, I am,

Sincerely yours,

Virginia Isbell
State Representative

TVP:KJ



HIGH TECHNOLOGY
DEVELOPMENT
CORPORATION

Central Pacific Plaza, 270 South King Street, Suite 252
Telephone (808) 548-8888

June 24, 1985

George R. Aryosh
Governor
K. TIM YEE
Lieutenant Governor
WILLIAM M. BRASS, JR.
Attorney General
HONOLULU, HAWAII

Mailing Address: P.O. Box 2399, Honolulu, Hawaii 96804

The Honorable Virginia Isbell
Representative
State of Hawaii
P.O. Box 926
Kealahou, Hawaii 96750

Dear Representative Isbell:

Subject: Environmental Impact Statement Preparation Notice--
Development Plan for the Hawaii Ocean Science &
Technology Park and Proposed Expansion of the Natural
Energy Laboratory of Hawaii at Keahole, North Kona,
Hawaii

Thank you for your comments on the subject notice of preparation. In answer to your specific concerns:

1. We share your concerns regarding the desirability of providing for the expansion of the ROST Park should the absorption rate warrant. We have discussed purchase of the adjoining private property and find him more interested in exchanging the parcel for other State-owned lands. We are working with the Department of Land and Natural Resources to determine whether a suitable parcel exists for this purpose. In the meantime, I hope you will agree that the ROST Park project has considerable merit at its present size and that the lack of an identified expansion area does not constitute an environmental impact per se.

2. At the present time, we are not convinced that the sewage outfall, as currently planned, would not present a problem because of the depth and distance of the ROST/NELH cold-water intake pipes. The County's plans will continue to be monitored to insure that the ROST/NELH resource is not compromised.

The Honorable Virginia Isbell
June 24, 1986
Page 2

3. Alternative methods of ocean water disposal have been studied. These methods and their environmental effects will be addressed in detail in the draft EIS.
The Honorable Virginia Isbell

We appreciate your interest in and support of this project and look forward to your comments on the draft EIS.

Sincerely,

William M. Bass, Jr.
Executive Director



Office of the
Mayor

DANTE K. CARPENTER
MAYOR

May 1, 1985

Mr. William M. Bass, Jr.
Executive Director
HIGH TECHNOLOGY DEVELOPMENT CORPORATION
P. O. Box 2359
Honolulu, HI 96804

Dear Mr. Bass:

I have received and reviewed your Notice of Preparation of an Environmental Impact Statement forwarded to this office for the HOST Park. You can be assured that my administration will continue to support this most important project.

To this date the County's concerns have been addressed through our representatives on the Board of Directors of the Natural Energy Lab of Hawaii. At this time I have three concerns:

- 1) Provisions for cold water supply to all potential HOST lot sites should be made while the present Governor and his administration are in office. Future administrations may not be as supportive of this park and funding improvements might be difficult. Cold water capacity for the entire park and future expansion should be considered when designing the 48" cold water pipe and the delivery system.
- 2) Future expansion of the HOST Park is limited on the North by the Keahole Airport and on the South by private landowners. Perhaps the State should acquire the private land now at a more reasonable rate, rather than wait when future expansion might be more costly. By providing cold water to all sites now, the lease rates would be higher and discourage the use of this park by those who could be served in the nearby conventional industrial parks. This could be one method of preserving this limited number of sites that have these special resources.

Mr. William M. Bass, Jr.
Page 2
May 1, 1985

- 3) Sufficient funding for the NELH must be assured. The "incubator system" that is available at NELH is an important part of the HOST project. The financial risks for a potential operation are far greater without the opportunity to test the concept at a similar site. Continued federal funding is a year by year proposition and is questionable for the future, therefore the State needs to assume more responsibility in keeping NELH sound.

I am sure you have considered these concerns in your studies. I would like to see them addressed to insure this project is a success. My administration stands ready to assist in this worthwhile endeavor.

Sincerely,

Dante K. Carpenter
Mayor, County of Hawaii

GM:ey

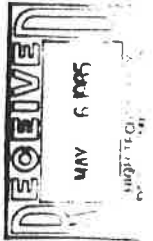

The Honorable Dante K. Carpenter
Page 2
May 28, 1985

In addition to providing these comments, I have asked Bill Bass, HTDC executive director, to continue to work closely with you and your staff in addressing these and other concerns that may arise as the development of the HOST Park proceeds.

May 28, 1985

With warm personal regards, I remain,

Yours very truly,

George R. Ariyoshi

The Honorable Dante K. Carpenter
Mayor, County of Hawaii
25 Aupunani Street
H110, Hawaii 96720

Dear Mayor Carpenter:

Thank you for your letter of May 1, 1985, regarding the Hawaii Ocean Science and Technology (HOST) Park. I appreciate your strong support for the project.

With regard to the cold water pipeline, we are having second thoughts about its size and desirability. As you may be aware, past efforts to deploy a 48-inch pipe were unsuccessful. In addition, it might be more beneficial to the HOST Park and the Natural Energy Laboratory of Hawaii (NELH) to deploy a series of smaller pipes (24 or 30 inches) to build in a redundancy to reduce the probability of a total outage should bad weather ever damage the system. The project is funded at \$7.855 million, and the number and sizes of the pipes will be determined during the design of the development.

I share your concern that adjoining lands should be identified and kept open for future expansion, if needed. The High Technology Development Corporation (HTDC) has had numerous discussions with the private land owners' representative about the land located to the south of the HOST Park. There has been no agreement yet on the value of the property, but the owners have indicated they would be open to a possible exchange of available state lands. The corporation and Department of Land and Natural Resources are exploring this option.

The NELH is, indeed, an important element of the state's technology transfer infrastructure at Keahole Point and will be an invaluable asset to the HOST Park's operation. I agree that we cannot rely solely on federal funding and the state must support the NELH. Presently, a master plan is being developed for the NELH to determine its long-term needs and provide a basis for decisions regarding future funding.

bcc: Hon. Kent M. Keith

GEORGE R. ARVOSH
KIM WEE
WILLIAM M. BASS, JR.
EXECUTIVE DIRECTOR



COUNTY COUNCIL

County of Hawaii
Hawaii County Building
25 Aupuni Street
Hilo, Hawaii 96720

April 10, 1985

Mr. William M. Bass, Jr.
Executive Director
High Technology Development Corp.
Central Pacific Plaza, Suite 252
220 South King Street
Honolulu, HI 96813

Dear Mr. Bass,

Re: Environmental Impact Statement Preparation
Notice - Development Plan For The Hawaii Ocean
Science & Technology Park and Proposed Expansion
Of The Natural Energy Laboratory of Hawaii at
Keanohe, North Kona, Hawaii

Thank you for forwarding us a copy of the subject document.

As you are aware, we are supporting your appropriation request to the
Legislature to fund the Hawaii Ocean Science & Technology Park
development.

We appreciate being kept informed on the progress of the HOST Park
and look forward to your preparation of the environmental impact
statement.

Sincerely,

Lorraine R. Jitchaku
Lorraine R. Jitchaku, Chairwoman
COMMITTEE ON ECONOMIC DEVELOPMENT

xc: Council Chairman



HIGH TECHNOLOGY
DEVELOPMENT
CORPORATION

Central Pacific Plaza, 220 South King Street, Suite 252
Honolulu, HI 96813

George R. Arvosh
Kim W. Lee
William M. Bass, Jr.
Executive Director

Mailing Address: P.O. Box 2359, Honolulu, Hawaii 96804

June 21, 1985

The Honorable Lorraine R. Jitchaku
Councilwoman
Committee on Economic Development
County of Hawaii
County Council
25 Aupuni Street
Hilo, Hawaii 96720

Dear Councilwoman Jitchaku:

Subject: Environmental Impact Statement Preparation Notice--
Development Plan for the Hawaii Ocean Science &
Technology Park and Proposed Expansion of the Natural
Energy Laboratory of Hawaii at Keanohe, North Kona,
Hawaii

Thank you for your comments on the subject notice of
preparation. We appreciate your support of this important
project and look forward to your review of the draft EIS.

Sincerely,

William M. Bass, Jr.
William M. Bass, Jr.
Executive Director





DEPARTMENT OF PARKS & RECREATION
COUNTY OF HAWAII

Dante K. Carpenter, Mayor
Patricia Engelhard, Director

April 16, 1985

Mr. William M. Bass, Jr.
High Technology Development Corporation
Central Pacific Plaza, Suite 252
220 South King Street
Honolulu, HI 96813

Subject: Hawaii Ocean Science & Technology Park and
Natural Energy Laboratory Expansion
Keahole, North Kona

We have reviewed the EIS Preparation Notice for the subject project
and have no adverse comments to offer.

Thank you for the opportunity to review the document.

Pat Engelhard
Pat Engelhard
Director

PE:CM:ai





PLANNING DEPARTMENT

25 ALIPIUNI STREET • HILO, HAWAII 97020
(808) 931-8200

COUNTY OF HAWAII

DANTE R. CARPENTER
Mayor

ALBERT LONO LYMAN
Director

ILIMA A. PHANAIA
Deputy Director

April 22, 1985

Mr. William M. Bass, Jr.
Executive Director
High Technology Development Corporation
P. O. Box 2359
Honolulu, Hawaii 96804

Dear Mr. Bass:

Hawaii Ocean Science & Technology Park (HOST) and Natural Energy Laboratory of Hawaii (NELH) Expansion Environmental Impact Statement (EIS) Preparation Notice
Keahole, North Kona, Hawaii

Thank you for the opportunity to review this EIS Preparation Notice. We have the following comments:

1. The three major "actions" outlined in your letter of March 21, 1985, are all related and by virtue of "lumping" has resulted in a complex situation intended to be "addressed" by a single document. For example, although both the High Technology Development Corporation (HTDC) and NELH are administratively assigned to the Department of Planning and Economic Development, they are nevertheless two separate entities. Each has its own mission, responsibilities, and liabilities. The scenarios presented are fine when "all goes well"; however, in the worst case, the liabilities each entity faces in the permitting process and in meeting the performance conditions which can be expected to be attached to the permits being sought should be discussed in greater detail in the EIS.
2. Much of the activity at NELH and HOST Park would work best as by-products of OTEC. A large amount of electrical energy will be required from the existing HELCO grid. How the electrical needs of the intended development(s) will be met needs to be amplified in the EIS. Similarly, the discussion on domestic water needs requires more detail.



Mr. William M. Bass, Jr.
Page 2
April 22, 1985

One cannot ascertain whether the existing water and electricity connections will be adequate or whether additional connections are necessary. Whether the same electrical corridor would be adequate for the export of OTEC-generated electricity into the HELCO grid needs to be addressed.

3. There are several references to "zones" such as Earthquake Zone 3, Class AA and Class A waters, tsunami and flooding, etc. Familiarity with these classifications are not necessarily general knowledge to everyone. Each of these "zones" and their significance should be clarified.
4. This Notice refers to the County of Hawaii's Shoreline Management Area Use Permit. This should corrected to read Special Management Area Use Permit.
5. The County General Plan designation is Industrial for the NELH site and Industrial and Conservation for the HOST site. The General Plan's Conservation designation is a strip running parallel to and makai of the Queen Kaahumanu Highway. It is intended to separate and buffer certain land uses from the principal entry into Kailua-Kona.
HTDC will be requesting "a County zoning change to Industrial". The County has two "Industrial" zones: General Industrial and Limited Industrial. Both the Ke-ahole Airport and the NELH site are in the General Industrial Zone (MG-1a). You may wish to have the EIS clarify which of the two County industrial zones you wish to seek.
6. In addition to selecting and planting bougainvillea, other landscaping alternatives should be considered and discussed in the EIS. The maintenance of this landscaping also needs to be addressed.
7. The Mamalahoa, or King's, Trail as well as other archaeological and historic sites should be discussed in greater detail in the EIS. It is difficult to ascertain the location and value of these sites as well as to analyze how they should be treated.
8. Upon approval and completion of all the proposed development(s) presented in this Notice, Ke-ahole Airport's future expansions appear to be limited to the north. The impacts of HOST on the airport needs to be discussed.

Mr. William M. Bass, Jr.
Page 3
April 22, 1985

Again, thank you for the opportunity to comment. I understand that other County of Hawaii agencies have reviewed your Notice and have responded to you directly. Should you have any questions, please contact us.

Sincerely,

Albert Lono Lyman
ALBERT LONO LYMAN
Planning Director

RN:gs



HIGH TECHNOLOGY DEVELOPMENT CORPORATION

Central Pacific Plaza 220 South King Street Suite 252
Telephone (808) 548-8648

GEORGE R. ARVONSON
Vice President
KIM YEE
Chairman
WILLIAM M. BASS, JR.
Executive Director

Mailing Address: P.O. Box 2359 Honolulu, Hawaii 96804

June 21, 1985

The Honorable Albert Lono Lyman
Planning Director
County of Hawaii Planning Department
25 Aupuni Street
Hilo, Hawaii 96720

Dear Mr. Lyman:

Subject: Environmental Impact Statement Preparation Notice--
Development Plan for the Hawaii Ocean Science &
Technology Park and Proposed Expansion of the Natural
Energy Laboratory of Hawaii at Keahole, North Kona,
Hawaii

Thank you for your comments on the subject notice of preparation. In response to your comments outlined in your letter of April 10, 1985:

1. Permit requirements for each facility will be addressed in the draft EIS.
2. Water and electrical requirements for both facilities will be discussed in the draft EIS. It is not anticipated at this time that OTEC generated power can be exported to the HELCO grid.
3. The zones mentioned will be clarified in the draft EIS.
4. The SMA definition will be corrected as requested.
5. A strip of open space will be retained along Queen Kaahumanu Highway fronting the Proposed HOST Park development. The exact dimensions of this strip will be coordinated with the County. At the present time it is anticipated that the zoning request will be for MG-3a.
6. Landscaping and landscaping maintenance will be discussed in general in the draft EIS. A landscaping plan will be submitted to the County along with a more detailed master plan as part of the SMA and zoning requests.

The Honorable Albert Lono Lyman,
June 21, 1985
Page 2

7. Archaeological sites and mitigation measures will be discussed in detail in the draft EIS.
8. Discussions with the DOT indicate that development of the HOST Park will not impact future airport expansion plans; airport expansion will be to the North.

Thank you for your comments and support of the project. We look forward to your review of the draft EIS.

Sincerely,

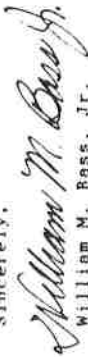
William M. Bass, Jr.
Executive Director

DEPARTMENT OF PUBLIC WORKS
COUNTY OF HAWAII
HILO, HAWAII

DATE April 18, 1985

Memorandum

TO Planning Department

FROM Chief Engineer

SUBJECT STATE LAND USE
BOUNDARY AMENDMENT/EIS PREPARATION NOTICE)
Applicant: STATE OF HAWAII/DPED
Location: KEAHOLE, NORTH KONA, HAWAII
TKR: 7-3-09:5 (POR); 7-3-43:3 (POR.)

We have reviewed the subject application and notice and our comments are as follows:

1. All development generated runoff shall be disposed on site and shall not be directed toward any adjacent properties. This would include individual property development.
2. In conformance with Chapter 27 of the Hawaii County Code a 100-year flood study would have to be conducted when the property is subdivided.
3. The immediate coastal areas are designated V-15 by the Federal Flood Insurance Rate Maps.
4. Although improvement requirements would be established at the time of rezoning, the applicant should be advised that curbs, gutter and sidewalks could be required.
5. Should a dedicable roadway without curbs, gutters and sidewalks be permitted, both swales and shoulders are to be paved with 1-1/2" of asphalt concrete.
6. Adequate on site parking or appropriate mitigating measures should be considered to minimize the possibility of illegal on street parking.

HUGH Y. ONO
Chief Engineer

cc: High Technology Development Corp.



HIGH TECHNOLOGY
DEVELOPMENT
CORPORATION

Central Executive Plaza 200 South King Street, Suite 202
Honolulu, HI 96819

June 26, 1985

Mailing Address: P.O. Box 2759 Honolulu, Hawaii 96814

GEORGE R. ANDERSON
President
KIMALEE
WILLIAM M. BASS, JR.
Executive Vice President

Mr. Hugh Y. Ono
Chief Engineer
Department of Public Works
County of Hawaii
25 Aupuni Street
Hilo, Hawaii 96720

Dear Mr. Ono:

Subject: Environmental Impact Statement Preparation Notice--
Development Plan for the Hawaii Ocean Science &
Technology Park and Proposed Expansion of the Natural
Energy Laboratory of Hawaii at Keahole, North Kona,
Hawaii

We have received a copy of your memorandum of April 18, 1985 to the County of Hawaii Planning Department. Our responses to your comments follow:

1. Drainage will not be diverted to adjoining properties. Drainage will be addressed in the draft EIS.
2. Chapter 27 requirements will be addressed in the detailed planning phase of the project which will commence shortly.
3. We note your comments on the Federal Flood Insurance Rate Maps. The map will be published in the draft EIS.
4. - 6. Your comments on improvements will be addressed in the detailed planning phase of the project. Appropriate variances will be requested if they are required.

Thank you for commenting on the subject notice of preparation. If you have any further questions or comments, please feel free to contact me at 548-8996. Future planning phases of the project will be coordinated with the County of Hawaii.

Sincerely,

William M. Bass, Jr.
William M. Bass, Jr.

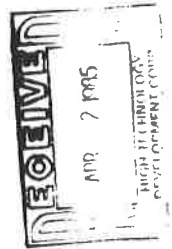

HIGH TECHNOLOGY DEVELOPMENT CORPORATION



GEORGE R. ARYOSH
GOVERNOR
K. TIM YEE
CHAIRMAN
WILLIAM M. BASS, JR.
EXECUTIVE DIRECTOR

Central Park, Plaza 220 South King Street, Suite 252
Honolulu, Hawaii 96804
Telephone: (808) 548-8800

Mailing Address: P.O. Box 2359, Honolulu, Hawaii 96804

HAWAII ELECTRIC LIGHT COMPANY, INC.
P. O. BOX 1027 HILLO, HAWAII-96720

April 29, 1985

High Technology Development Corporation
P. O. Box 2359
Honolulu, Hawaii 96804

Attention: Mr. William M. Bass, Jr.
Executive Director

Gentlemen:

Thank you for the opportunity to review your Environmental Impact Statement for the Hawaii Ocean Science and Technology Park proposed at Keahole. In reviewing the documents, we find that some additional information may be helpful.

Currently, the Natural Energy Laboratory is being served from Keahole Airport by an underground cable. To service the new Ocean Science and Technology Park, HELCO is proposing that service be fed from a new substation or off the existing substations at Keahole Airport and/or at Kaloko. This will require a distribution line to be tapped from these locations, fed underground across Queen Kaahumanu highway and underground to the site. In order to adequately determine the capacity of the proposed facilities, an estimated 10 year demand KVA load projection of the High Tech Park will be required.

On page 9 under "Utilities," it has been stated that "underground electrical conduits will be provided in the same corridors as the domestic water lines." Please note that all underground conduits will have to be installed to HELCO's specifications by the developers contractors and will have a minimum separation between underground electrical conduits and the Department of Water Supply lines.

I hope these comments can be incorporated in your Environmental Impact Statement. If you have any questions, please feel free to contact me.

Very truly yours,

Alva K. Nakamura, Manager
Engineering Department

AKW:ts

June 21, 1985

Mr. Alva K. Nakamura
Manager
Engineering Department
Hawaii Electric Light Company, Inc.
P.O. Box 1027
Hilo, Hawaii 96720

Dear Mr. Nakamura:

Subject: Environmental Impact Statement Preparation Notice--
Development Plan for the Hawaii Ocean Science &
Technology Park and Proposed Expansion of the Natural
Energy Laboratory of Hawaii at Keahole, North Kona,
Hawaii

Thank you for your comments on the subject notice of preparation. We will continue to keep you informed of our plans as they affect HELCO. Your comments will be incorporated into the draft EIS.

We appreciate all of the assistance that you have given us on this project and look forward to your comments on the draft EIS.

Sincerely,

William M. Bass, Jr.
Executive Director

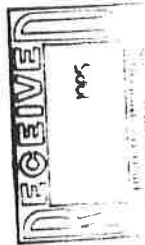

**HIGH TECHNOLOGY
DEVELOPMENT
CORPORATION**



Central Pacific Plaza 270 South King Street Suite 252
Telephone (808) 548-0006

GEORGE R. ARYOSHI
K. TIM VEE
WILLIAM M. BASS, JR.
Executive Director

Mailing Address P.O. Box 2395 Honolulu, Hawaii 96804

HAWAIIAN TELEPHONE
(11)

April 26, 1985

Mr. William M. Bass, Jr.
High Technology Development Corporation
Central Pacific Plaza, Suite 252
270 South King Street
Honolulu, Hawaii 96813

Dear Mr. Bass:

Environmental Impact Statement Preparation Notice-Development Plan for the Hawaii Ocean Science & Technology Park and Proposed Expansion of the Natural Energy Laboratory of Hawaii at Keshole, North Kona, Hawaii

Thank you for the opportunity to comment on your proposed project.

Hawaiian Telephone presently has an existing 3" conduit serving the existing facilities which will be inadequate to ultimately serve the proposed development. Please include under 5.0 Phase I Plan, Utilities, a provision for Underground Telephone conduits to be provided in the same corridors as the underground electrical and domestic water lines. Details of our requirements should be coordinated with Mr. Kenneth Tanaka (Ph. 935-9459) of our Hilo office.

The construction of underground conduits and installation of cables, should have no significant adverse impact upon the environment.

If you have any questions, please call me at 834-6221.

Sincerely,

G. Kaneko
G. Kaneko
Oahu Engineering & Construction
Manager

cc: Kenneth Tanaka

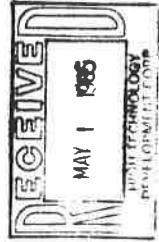

June 21, 1985

Mr. G. Kaneko
Oahu Engineering and
Construction Manager
Hawaiian Telephone
P.O. Box 2200
Honolulu, Hawaii 96841

Dear Mr. Kaneko:

Subject: Environmental Impact Statement Preparation Notice--
Development Plan for the Hawaii Ocean Science &
Technology Park and Proposed Expansion of the Natural
Energy Laboratory of Hawaii at Keshole, North Kona,
Hawaii

Thank you for your comments on the subject notice of preparation. A provision for underground telephone conduits will be incorporated into the master plan and facility design. The design consultant will coordinate with Mr. Kenneth Tanaka of your office.

Sincerely,

William M. Bass, Jr.
William M. Bass, Jr.
Executive Director

Mr. Roger Harris
April 8, 1985
Page 2

We welcome your comments on the proposed action and any suggestions you may have for additional items to be addressed in the environmental impact statement. Please note that the deadline for comments is April 23, 1985. Comments should be sent to:

Mr. William M. Bass, Jr.
High Technology Development Corporation
Central Pacific Plaza, Suite 252,
220 South King Street,
Honolulu, Hawaii 96813

Very truly yours,

William M. Bass, Jr.
Executive Director

Attachment

B I S H O P M U S E U M

1525 BERNIKE STREET • P.O. BOX 10000-A • HONOLULU, HAWAII 96817 • (808) 847-3511

14 April 1985

Mr. William M. Bass, Jr.
High Technology Development Corp.
Central Pacific Plaza
Suite 252, 220 S. King St.
Honolulu, HI 96813

Dear Mr. Bass:

I hereby request to be a consulted party during the preparation of the Environmental Impact Statement for the DEVELOPMENT PLAN FOR THE HAWAII OCEAN SCIENCE AND TECHNOLOGY PARK AND PROPOSED EXPANSION OF THE NATURAL ENERGY LABORATORY OF HAWAII AT KEAHOLE, NORTH KONA, HAWAII. The notice appeared in the March 23, 1985 DEOC BULLETIN.

Last year I was contacted concerning the possibility of conducting a survey of the invertebrates on the lava flows and in the caves on the subject property. However, other commitments prevented us from developing a contract. The most logical time to conduct such a survey would be during or just following the winter rains.

The nearly barren lava flows near Keahole Point appear as an inhospitable environment and nearly devoid of living organisms. However, recently the young lava flows on Hawaii Island have been shown to support an interesting and important assemblage of subterranean animals. Some of these hide in cracks and caves by day and come to the surface at night to feed on windborne debris scattered on the surface (See Howarth, 1979, Pacific Insects 20:133-144.). Others are specialized both physiologically and morphologically, to exploit the subterranean environment. These latter include terrestrial species living in lava tubes and cracks in the young flows and aquatic species living in the mixohaline zone between freshwater and marine environments.

There is considerable overlap in the location of these resources and the archaeological resources since the early Hawaiians often used cave entrances and springs in order to exploit this dry environment. Therefore the project plans to preserve the more significant archaeological sites may also serve to protect some of the associated animal communities, if appropriate mitigative measures are included.

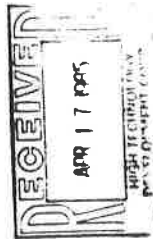



HIGH TECHNOLOGY DEVELOPMENT CORPORATION

Central Pacific Plaza, 220 South King Street, Suite 202
Honolulu (808) 549-6800

George R. Ariyoshi
Governor
K. TIM YEE
Commissioner
WILLIAM M. BAIG JR.
Assistant Secretary

Mailing Address: P.O. Box 2396, Honolulu, Hawaii 96804

April 18, 1985

Of special concern is the continued existence of the anchialine springs, which were important to Hawaiian settlement of the area and are important for survival and study of the aquatic fauna. Water quality in the springs and even its continued presence may be seriously jeopardized by grading or construction activities nearby or between the spring and the sea. These springs require continued subterranean connections to the ocean in order to sustain their biological communities. Since these springs and associated subterranean aquatic environments share many species and higher taxa with the deep sea and yet are a more convenient habitat to study than the deep sea, preserving these springs and providing for their study are well within the scope and purview of the proposed Hawaii Ocean Science and Technology Park.

Thank you for your consideration.

Sincerely,

Francis G. Howerth
Francis G. Howerth
Entomologist

cc: Ms Marilyn C. Metz
Dr. John T. Harrison

Mr. Francis G. Howerth
Entomologist
Bishop Museum
P.O. Box 19000-A
Honolulu, Hawaii 96817

Dear Mr. Howerth:

Subject: Environmental Impact Statement Preparation Notice -- Development Plan For The Hawaii Ocean Science & Technology Park and Proposed Expansion of the Natural Energy Laboratory of Hawaii At Keahole North Kona, Hawaii.

The High Technology Development Corporation is preparing an environmental impact statement for the subject developments. A copy of the environmental assessment and notice of preparation of an environmental impact statement for the project is attached. The proposed actions will include:

- Development of 547 acres of vacant land adjacent to the Keahole-Kona Airport, which is currently covered with lava flows, into an Ocean Science and Technology Park for commercial development of aquaculture/mariculture products and other related activities;
- Expansion of the existing research facilities at the adjacent Natural Energy Laboratory of Hawaii to incorporate commercial aquaculture/mariculture demonstration modules and additional energy projects; and,
- Installation of permanent pipes in the ocean, offshore of Keahole Point, to support the ocean water requirements of the above projects.

The proposed Hawaii Ocean Science & Technology Park will provide space and facilities for the commercialization of projects developed at the Natural Energy Laboratory of Hawaii.



HIGH TECHNOLOGY DEVELOPMENT CORPORATION

Central Pacific Plaza, 220 South King Street, Suite 252
Telephone (808) 546-8988

June 21, 1985

Mailing Address PO Box 2299 Honolulu, Hawaii 96800

GEORGE R. ARVID,
K. T. M. V.
WILLIAM M. BASS, Jr.,
Executive Director

Mr. Francis G. Howarth
April 18, 1985
Page 2

We welcome your comments on the proposed action and any suggestions you may have for additional items to be addressed in the environmental impact statement. Please note that the deadline for comments is April 23, 1985. Comments should be sent to:

Mr. William M. Bass, Jr.
High Technology Development Corporation
Central Pacific Plaza, Suite 252
220 South King Street
Honolulu, Hawaii 96813

Very truly yours,

William M. Bass, Jr.
Executive Director

Attachment

Mr. Francis G. Howarth
Entomologist
Bernice P. Bishop Museum
P.O. Box 19000-A
Honolulu, Hawaii 96817

Dear Mr. Howarth:

Subject: Environmental Impact Statement Preparation Notice--
Development Plan for the Hawaii Ocean Science &
Technology Park and Proposed Expansion of the Natural
Energy Laboratory of Hawaii at Keahole, North Kona,
Hawaii

Thank you for your interest in the subject project. We mailed you a copy of the notice of preparation on April 18, 1985 and to date have received no further comments from you; our consultant, Ms. Marilyn Metz of The Traverse Group, Inc. has been unable to reach you by phone. We are planning to file the draft EIS on July 5, 1985. Please contact Ms. Metz at 732-7143 by June 28, 1985 if you have any further comments on the project.

At the present time we are not certain if all of the anchalinal ponds that were mentioned in the NOP are still in existence. The Army Corps of Engineers has agreed to visit the sites and verify the number of ponds and their location. Although, as stated in the NOP, the ponds were not considered significant by Maciolek and Brock during their 1975 survey, a marine biologist is addressing the biological values of the ponds as reported in their study.

Archaeological mitigation measures will be addressed in the draft EIS and incorporated into future construction contracts. We are interested in learning more about the mitigating measures that you alluded to in your letter of April 14, 1985.

We look forward to your comments on the draft EIS.

Sincerely,

William M. Bass, Jr.

REFERENCES

- Admission Act of March 18, 1959, 735 Stat. 4 (Hawaii).
- Balazs, G.H. 1980. Synopsis of Biological Data on the Green Turtle in the Hawaiian Islands. NOAA-TM-NMFS-SWFC-7. 141p.
- Bernice P. Bishop Museum. 1984. An Archaeological Reconnaissance of the Natural Energy Laboratory of Hawaii (NELH) Property, Keahole Point, North Kona, Hawaii. Department of Anthropology. Ms. 110784. Honolulu, Hawaii.
- Bathen, K.H., R.M. Kamins, D. Kornreich and J.E.T. Moncur. 1975. An Evaluation of Oceanographic and Socio-Economic Aspects of a Nearshore Ocean Thermal Energy Conversion Pilot Plant in Subtropical Hawaiian Waters.
- Bienfang, P.K. 1975. The Oceanography of Honokohau Harbor, Hawaii. Appendix B, EIS for Honokohau Harbor, Harbors Div. State of Hawaii.
- Brewer, W.A., J.P. Huizingh and J.A. Sexton. 1985. Hawaii's OTEC Park Triggers High-tech Aquaculture Development. INFOFISH Marketing Digest No. 1/85, 18-21.
- Brock, J.H. and R.E. Brock. 1974. The Marine Fauna of the Coast of Northern Kona, Hawaii. UNIH-SEAGRANT-AR-74-02. 30p.
- Chapter 205, Hawaii Revised Statutes, as amended.
- Chapter 205-A, Hawaii Revised Statutes.
- Chapter 344, Hawaii Revised Statutes.
- Chiniago, Inc. 1985. Keahole Point, Hawaii: Archaeological Reconnaissance. Prepared for the High Technology Development Corporation. Honolulu, Hawaii.
- County of Hawaii. 1971. The General Plan of the County of Hawaii. Hilo, Hawaii.
- County of Hawaii. 1980. General Plan Revisions. Hilo, Hawaii.
- Cox, Doak C. 1982. Tsunami Hazard At Keahole Point. UH Environmental Center. Special Rpt. 0028. Honolulu, Hawaii.
- Department of Land and Natural Resources (DLNR). 1981. Mariculture and Ocean Thermal Energy Conversion State-of-the-Art Assessments. Aquaculture Development Program, Honolulu, Hawaii.
- Department of Land and Natural Resources. 1980. Title 13, Chapter 2. Regulating Uses Within the State Conservation District. Honolulu, Hawaii.
- Department of Planning and Economic Development (DPED). 1978. The Hawaii State Plan. Honolulu, Hawaii.

- Department of Planning and Economic Development (DPED). 1983. The State of Hawaii Data Book. Honolulu, Hawaii.
- Edmundson, C.E. 1971. Reef and Shore Fauna of Hawaii. B.P. Bishop Museum Mus. Spec. Publ. 64(1). Honolulu: Bishop Mus. Press.
- Harrison, J. 1985. Survey of Benthic Organisms from the Depths of 60 to 200 meters off Ke-ahole Point, Hawaii. Draft. Marine Sciences Group, Univ. of Cal., Berkeley. MSG-85-007.
- Hawaii Department of Land and Natural Resources. 1980. Hawaii Coastal Zone Fisheries Management Study. 172 p.
- Hawaii State, 12th Legislature, House, 1985. Requesting The High Technology Development Corporation To Assist Ongoing High Technology Developments, To Identify High Technology Development Sites On A Statewide Basis, And To Streamline Permit Procedures And Recommend Incentives For High Technology Developments. H.R.C. 138 and H.R. 364.
- Helber, Hastert, Van Horn & Kimura, Inc. 1985. Hawaiian Ocean Science & Technology Park Marketing & Feasibility Studies. Prepared for the High Technology Development Corporation, Honolulu, Hawaii.
- High Technology Development Corporation (HTDC). 1984. Statewide Strategy For High Technology Growth. Honolulu, Hawaii.
- Index...1916. Index of all Grants and Patents Land Sales. Honolulu: Paradise Pacific Print.
- Indices...1929. Indices of Awards Made by the Board of Commissioner to Quiet Land Titles in the Hawaiian Islands. Honolulu: Comm. Pub. Lands, Terr. Hawaii.
- Kamakau, S.M. 1961. Ruling Chiefs of Hawaii. Honolulu: Kamehameha Schools Press.
- Kanehiro, B.Y., and Peterson, F.L. 1977. Groundwater recharge and coastal discharge for the northwest coast of the island of Hawaii, a computerized water budget approach. Tech. Rep. No. 110, Water Resources Research Center, University of Hawaii.
- Kelly, M. 1971. Kekaha: 'Aina Malo'o: Historical Survey and Background of Kaloko and Kuki'o AHupua'a, North Kona, Hawaii. Departmental Report Series 71-2, Dept. Anthropology, B.P. Bishop Mus.
- Maciolek, J.A., and R.E. Brock. 1974. Aquatic Survey of the Kona Coast Ponds, Hawaii Island. UNJHI-SEAGRANT-AR-74-04. 73p.
- Marine Sciences Group. 1985. Potential Environmental Impacts of Open-Cycle Ocean Thermal Energy Conversion. University of California, Department of Paleontology. MSG-84-009. Berkeley, California.

- Matsumoto, W.M. 1984. Potential Impact of Ocean Thermal Energy Conversion (OTEC) Operation on Fisheries. Adm. Rept. H-84-4, Southw. Fish. Cent. Hon. Labor., Natl. Mar. Fish. Serv./NOAA, Honolulu. 29 p.
- Mullineaux, Donald R. and Donald W. Peterson. 1974. Volcanic Hazards on the Island of Hawaii. U.S. Geological Survey, Open-File Report 74-239. Washington, D.C..
- Myers, E., D. Hoss, W. Matsumoto, D. Peters, M. Seki, R. Uchida, J. Ditmars, and R. Paddock. 1985. The Potential Impact of Ocean Thermal Energy Conversion (OTEC) on Fisheries. NOAA, National Ocean Service, Office of Ocean and Coastal Resource Management, Washington, D.C. Nine individually-paged sections.
- Noda, E.K., P.K. Bienfang and D.A. Ziemann. 1980. OTEC Environmental Benchmark Survey off Keahole Point, Hawaii. Univ. of Hawaii, J.K.K. Look Lab. of Oceanographic Engineering Contract Report No. 80-1.
- Ocean Research Consulting and Analysis, Ltd. (ORCA). 1977. Coral reef survey: Keahole Point, Hawaii (winter months) for the Natural Energy Laboratory OTEC facility, State of Hawaii. Hawaii Dept. Planning and Economic Development. 115 p.
- Ocean Research Consulting and Analysis, Ltd. 1978. Coral reef survey: Keahole Point, Hawaii (summer months) for the Natural Energy Laboratory OTEC facility, State of Hawaii. Hawaii Dept. Planning and Economic Development. 119 p.
- Parsons Hawaii. 1984. Conceptual Study of Onshore/Offshore Seawater Piping and Pump Station. Phase I, Expanded Test Facility (ETF), Keahole Point, Hawaii.
- Pukui, M.K., S.R. Elbert, and E.T. Mookini. 1974. Place Names of Hawaii. Honolulu: Univ. Press Hawaii.
- Pukui, M.K., and S.R. Elbert. 1973. Hawaiian Dictionary. Honolulu: Univ. Press Hawaii.
- R.M. Towill Corporation. 1976. Environmental Impact Statement For The Natural Energy Laboratory Of Hawaii At Keahole Point, Hawaii (Phase I). Prepared for the Research Corporation of the University of Hawaii. Honolulu, Hawaii.
- R.M. Towill Corporation. 1982. Kona Ocean Outfall: Application for Secondary Treatment Requirements for Discharge into Marine Waters.
- SETS INC. 1983. Engineering Design for Solar Pond OTEC (SPOTEC) Power Plants at Ke-ahole Point. Prepared for the Hawaii Department of Planning and Economic Development. Honolulu, Hawaii.
- Shallenberger, E.W. 1979. The Status of Hawaiian Cetaceans. Rept. Prep. for U.S. Marine Mammal Commission. 103p.
- U.S. Dept.of Commerce, NOAA, Office of Ocean and Coastal Resource Management, Sanctuary Programs Division, and Hawaii Dept. of Planning and

Economic Development. 1983. Draft Management Plan and Environmental Impact Statement for the Proposed Hawaii Humpback Whale National Marine Sanctuary. Wash., D.C.

U.S. Department of Energy. 1985. Federal Ocean Energy Technology Program. Final Draft of Multi-Year Program Plan, FY85 - FY89. Washington, D.C.

U.S. Department of Transportation, Federal Aviation Administration. 1975. Federal Aviation Regulations: Part 77 - Objects Affecting Navigable Airspace. Washington, D.C.

Walsh, T.W. 1984. A Description of Water Quality Parameters Measured on Seawaters Collected During 1981 to 1983 at the Natural Energy Lab of Hawaii. Univ. of Hawaii, Institute of Marine Biology.

Walsh, T.W. 1985. Environmental Survey of Keahole Point - Kailua Kona Hawaii: Water Quality Chemistry Baseline (NOV 1984). UH-HIMB.

Walsh, W.J., III. 1984. Aspects of Nocturnal Shelter, Habitat Space, and Juvenile Recruitment in Hawaiian Coral Reef Species. Ph. D. dissert. (Zoology), Univ. Hawaii. 475 p.

Water Resources Research Center, Univ. of Hawaii. 1980. Proposed Prototype Testing Program, Land Disposal by Injection Wells of Ocean Water Effluent at Seacoast Test Facility, Keahole Point, Hawaii. Report submitted to Lawrence Hallenger, Executive Director, National Energy Laboratory of Hawaii, by L. Stephen Lau, Water Resources Research Center, 3 Sept. 1980.

APPENDIX A

**RECOMMENDATIONS FOR POTENTIAL AQUACULTURE
PROJECTS AT NELH/HOST PARK**

**THE TRAVERSE GROUP, INC.
JUNE 1985**

RECOMMENDATIONS FOR POTENTIAL AQUACULTURE PROJECTS AT NELH/HOST PARK

The following sections present various types of aquatic life that would be potential aquaculture candidates for the NELH and HOST Park facilities. This summary is intended to be a preliminary recommendation of various organisms presently cultured in the U.S. and/or other parts of the world. Prior to attempting commercial production or R and D development, much more detailed technological and economic investigation is advised.

These comments are based on the reports of the seawater pumped at the NELH site in Hawaii dated 7/83 for water quality and 10/84 for solar radiation. It is assumed that desired culture temperature can be achieved either by mixing deep water with surface water or by utilizing solar energy.

ALGAL CULTURE

The culture of various types of micro- and macro-algae is the most attractive type of aquaculture for a facility producing large quantities of nutrient rich water. Algae provides an opportunity to produce significant quantities of food for human consumption; food items for the culture of mollusks, larval crustaceans, and finfish; industrial colloids and agars; and pharmaceuticals.

The micro-algae are single celled organisms which utilize the energy of the sun, available nutrients, and carbon dioxide to build proteins, fatty acids, and carbohydrates. Many of these products are necessary for the growth and survival of filter feeders (mollusks), larval crustaceans, and finfish. The production of micro-algae, like diatoms of phytoplankton, can be performed in either raceway, tank or pond culture operations, any of which are feasible at NELH or HOST Park.

Chaetoceros is a genus of phytoplankton commonly used as feed for larval shrimp. Historically it has been grown in pure culture to its maximum density (growth of phytoplankton is exponential to the point of nutrient depletion or metabolite buildup), harvested, and fed to the herbivorous stages of larval shrimp. There has recently been a great deal of success feeding frozen Chaetoceros to larval shrimp at Texas A & M University. This suggests that there may be an impetus for commercial production of Chaetoceros, depending on the needs of local hatcheries.

In Italy, three types of phytoplankton have been in commercial production for several years. Dunaliella, Tetraselmis, and Spiroulina have been grown in shallow ponds of 20x50 meters. Paddlewheels were used for aeration. Production was reported to be 65 tons dry weight per year based on 2.5 years of data. The number of ponds was not reported. Tetraselmis was frozen for larval crustacean culture. Spiroulina was dried and added to cattle and chicken feed. There was no water exchange reported; however, most plankton culture is stagnant (without exchange) during the growout period.

Culture of any phytoplankton can be accomplished using continuous culture techniques or using stagnant culture methods. Continuous culture involves slow

moving shallow water in a highly controlled structure like a raceway. Water is usually pumped at about 6-10 cm/sec (a rate that allows the culture to reach the desired density). At the end of the raceway the cells are either harvested or the water is pumped to another modular system where the cells can serve as food items. In the "closed system" where the cells are harvested, the water is usually reused pending the addition of necessary nutrients.

Stagnant culture involves a tank or pond in which a "spike" of the desired organism is added to fertilized water. The system is aerated using pumped air or paddlewheels until the culture reaches its maximum density (approximately 200,000 to 500,000 cells per ml). This can take from five days to two weeks depending on stocking density and volume of the growth area. For example, Phaeodactylum is a brown algae which is fed to larval shrimp (Penaeus vannamei, P. stylirostris, and P. japonicus). It has been grown and harvested at a rate of 500 g (dry wt.)/cubic meter/day. For comparison, the highest fresh water production of algae found was 30 gm (dry wt)/cu meter/day. Theoretically, a one hectare pond, one meter deep would produce five metric tons (dry weight) of Phaeodactylum per day.

Micro-algae could be either harvested for sale or used as feed in a modular system on site. Both options would be supportive of Hawaii's aquaculture interests. Since most shrimp hatcheries produce their own plankton, prices would be established locally; however, there are commercial larval shrimp feeds on the market which could provide a price base in the U.S. Other micro-algae (e.g., Spiroulina) can be harvested, dried and sold as a supplement to live-stock feed companies. The price would be determined locally.

The NELH/HOST Park facilities should have an advantage over most shrimp hatcheries in that hatcheries are frequently plagued with contamination by undesirable organisms, not to mention cost of high grade fertilizers. The nature of the deep ocean water would virtually eliminate contamination problems as well as reduce fertilization needs (if there are any). These advantages would help make shrimp culture more economically attractive in Hawaii.

The culture of macro-algae is in practice in many parts of the world including the U.S. Macro-algae is produced in Japan and experimentally at NELH for food; e.g., Porphyra. Macro-algae also plays an important role in industry as it is the source of agars used in food and microbiology and is the source of carrageenan used in making colloids like gelatin, fat stabilizers, emulsion stabilizers, dessert gels, pizza, antibiotic stabilizers, and fertilizer encapsulators.

Gelidium has been found to be the only macro-algae from which microbiological grade agar can be produced. American Agar, based in California, is the only U.S. firm which produces this high quality product. At the present time, they must import Gelidium because domestic supplies have been exhausted. There were no reports available on commercial scale culture facilities of Gelidium; however, experimental cascade culture systems (stacked raceways) have produced 10-17 gm (dry wt)/day/square meter. Agar yield of Gelidium is 20 percent and sells for more than \$200/kg. A 0.1 hectare pond could yield three kg of micro-grade agar per day.

Other agar producing macro-algae have been produced through commercial growout. In Israel, Gracilaria is cultured in impoundments which yield 10 tons per hectare (dry

Recent advances in the shrimp mariculture industry have led to enthusiastic entrepreneurship worldwide and Hawaii is no exception. Intensive culture techniques, like raceway and small pond cultivation of shrimp in tropical climates, have made feasible 2-3 crops per year and brought shrimp culture to a profitable level. The primary constraint of the industry is insufficient seed stock. The facilities at Keahole offer an opportunity to establish a shrimp hatchery which would not only help meet local demands, but also stimulate the establishment of additional shrimp farms.

A shrimp hatchery capable of producing 10 million post larvae (pls) every three weeks (enough to stock 200 acres at 50,000 pls per acre) would require 8,000-10,000 sq ft. of building space. An indoor maturation area would be necessary for housing a broodstock of 200-300 animals. Circular maturation tanks 5-6 meters in diameter and 60-70 cm deep have been shown to be the most effective for shrimp copulation in captivity. Three tanks of this size would be sufficient to hold and acclimate broodstock and induce spawning. In addition, two 0.1 hectare ponds would be necessary outside the facility to rear and hold broodstock for future use. The maturation tanks would require 100 gallons per minute flow rate for three exchanges per day. The ponds would require approximately 100 gallons per minute for a 50 percent exchange per day.

The hatchery rearing part of the facility would consist of twenty 4-5 meter diameter conical tanks each holding 20,000 liters when full. Following spawning, the tanks containing the larval shrimp would be gradually filled as the larvae grow so there is no exchange necessary until about the seventh day. Assuming ponds are stocked with PL7-PL10, (7 to 10 days at the post larval stage), there would be a need to exchange water at 50 percent per day for 10-14 days out of each 24 day cycle. This would require 200,000 liters per day or a little less than 100 gallons per minute.

The characteristics of Keahole would be advantageous for any type of hatchery because of the on-site capability of producing food for the larvae. In the case of a shrimp hatchery, ample phytoplankton and Artemia could be produced in ten to fifteen 5,000 liter tanks (see above), and two 20,000 liter raceways. Other support facilities which would require some pumped water in the hatchery would be a plankton culture room, a lab, and a harvest area. Solar collectors could be built into the roof to acquire the desired temperatures.

MOLLUSK CULTURE

There are several species of mollusks which are attractive aquaculture candidates for the NELH/HOST Park sites. Mollusks are filter feeders which means that the costs of the feed would be minimal since plankton production at the facility would be part of the operation.

In terms of economic return, clams (*Mercentaria*) and oysters (*Crassostrea* and *Ostrea*) have the highest market value in the U.S. However, shipping costs of fresh product (in the shell) to the mainland might not be cost effective. Either a local market should be identified or processing (shucking) would have to be performed on site, to reduce shipping weight.

wt) per year. Depending on the quality, Gracilaria sells for \$700 - \$1000 per ton. The operation claims a 50 percent profit.

Laminaria is a medium grade food in Japan, a source of cattle feed supplement in Ireland, and a source of agar for the food industry. Laminaria has been grown in both tanks and in raceways and produced 14 gm (dry wt) /sq meter /day (about the same yield as Gelidium).

A ten hectare macro-algae facility at HOST Park might yield 100 or so tons of dried plant material per year. The value would depend on where processing facilities were located (on site is not unreasonable). A ten hectare facility would require 50 percent exchange of water per day (continuous-flow) which would equal 5,000 to 10,000 gallons per minute. Paddlewheel aeration and some recirculation would be an effective way to reduce pumping needs.

CRUSTACEAN CULTURE

The culture of crustaceans at NELH or HOST Park is attractive because it already has a track record in the state. Shrimp has been under experimental development for many years and the water quality, reduced pumping costs, and land availability should provide a greater margin of profit. Artemia culture would also be feasible at this site because shrimp hatcheries and the aquarium industry are highly dependent on the availability of brine shrimp.

There have been various attempts to culture Artemia throughout the world. In most cases, Artemia cysts are used as seed stock. The newly hatched nauplii are either used as feed for larval fish and shrimp or the nauplii are raised to adult size and harvested. Following harvest the brine shrimp are either packaged and frozen for the aquarium industry or, in some cases, freeze-dried. Dried Artemia is a source of protein in shrimp and livestock feeds.

Production levels vary depending on the type of system used. SEAFDEC in the Philippines reported that continuous culture of Artemia (allowing the adults to produce offspring) yielded 3-5 kgs (wet wt)/cubic meter/day. Pond production of Artemia at the same facility yielded 150 gm (dry wt)/cu meter/day (1.5 kg wet). The St. Croix upwelling facility reported that 15 gms of cysts yielded 2 kg (dry wt) of Artemia in two weeks. A Florida firm, which closed down due to bacterial contamination (attributed to constant high temperatures), reported that sixteen 20,000 gallon raceways produced 200 kg/week of live Artemia. These were sold live to the aquarium industry for \$22/kg (1980). Artemia were introduced as cysts and hatched. This was reported as a stagnant system; therefore, water exchange occurred following each harvest (320,000 gallons/wk).

Artemia feed on a variety of phytoplankton which could be produced at NELH/HOST Park. The flow rate in a raceway or pond system would be determined by maintenance of the proper plankton density and oxygen levels; however, due to the high solar radiation levels and available nutrients, exchange rates should be less than 50 percent per day.

Oyster growth in intensive culture has been demonstrated to be 3 to 5 times that of wild oysters. An experimental oyster farm in Hawaii reported that Pacific oysters grew to market size in 6 to 9 months. The oysters were raised in concrete raceways with windmill pumped water. Plankton raised in nearby ponds was added to the water to supplement the low plankton levels in the ocean water.

The eyed-larvae (presettlement) of oysters can be purchased at a low cost from one of several California firms in operation. The larvae are held in 5,000-7,000 gallon tanks at 20-24°C for about five days with no exchange. The tanks have racks of cracked shell which provide a settlement surface. Commercial operations report that 20 percent of 10,000,000 or so eyed-larvae stocked into each settling tank will usually settle to spat. Following settlement, phytoplankton are introduced as a food source. Chaetoceros has been shown to produce the most rapid growth rates (3 to 5 times that of natural waters). The density of oysters in the growout trenches and consequent flow rates would be determined by plankton requirements. Less than 1000 gal per minute would be sufficient for a six hectare raceway system.

A unique advantage of the NELH/HOST Park sites would be that temperature control prior to harvest could induce accumulation of fatty material and curtail spawning. The quality of oysters cultured in warm water has been reported to be less than desirable because of the development of gonads. Once the oysters reach harvest size, a slow reduction in temperature over a two week period to 13 to 15°C to simulate winter would assure a higher quality product. This cool water would be available on site.

Another member of the mollusks which has an aquaculture track record is *Tapes*. There is some demand for this clam in Japan where it sells for \$0.40 - \$0.70 /kg (in the shell), and in California where it sells for \$0.60 - \$0.75/lb. (meat). However, it has recently been cultured as a source of food for shrimp and finfish culture operations.

In raceway culture, 0.1 gm seed are stocked at 250-550 clams/cubic meter and grow to market size (10 gm) in about 190 days. Some aquaculturists use them at 3-5 gm sizes which they reach in 120 days. Hatchery reared seed stock cost about \$.001 each. Production figures from Japan indicate 42.3 tons (whole weight)/year/hectare is not uncommon. At the St. Croix upwelling project 19-45 tons/hectare/year were reported. Flow rates in raceway culture were reported to be 50 cm/sec in the St. Croix system in 2x8 foot raceways. Culture in a five hectare pond area would require 1000 gallons or so per minute.

FINFISH CULTURE

Fish groups which would be most compatible with the NELH/HOST Park facilities would be the herbivores and detritivores. These include mullet, tilapia, and carp. Although these fish would do very well at Keahole, there may be some marketing problems. Tilapia and carp are not well accepted food items in the U.S. Due to the abundance of traditional fish in Hawaii, these culture candidates may be difficult to market. Mullet has a modest record of culture in Hawaii and there is some local demand for this fish; therefore, it may be worthwhile as an aquaculture candidate.

Mullet are a hearty fish species and are relatively tolerant to low dissolved oxygen. They have been successfully reared under hatchery conditions at The Oceanic Institute in Hawaii, Taiwan, Philippines, and there has been some experimental spawning on the East Coast of the U.S. Yields have been reported to range from 1 to 2 tons/hectare/6 months. Water exchange rates of 5 to 10 percent per day are sufficient, so a ten hectare growout area would need 500 - 1000 gallons per minute.

Other fish species, like white bass hybrids, have been demonstrated to be commercially feasible and may be good candidates for the site. However, these fish require a prepared commercial feed or natural feeds that would be difficult to produce economically on-site. The advantage of NELH would be that a hatchery could be established on-site where the fish could be reared to the juvenile stages. There could also be some supplemental feed production like *Tapes* (clam); however, other types of nutrition would be necessary. These fish do well in cage culture; consequently, hatchery production could occur on-site and growout could be established in the shallow waters adjacent to the pumping site at NELH. The water pumping demands would be similar to the shrimp hatchery scenario (above). It is important to establish sufficient feed supplies to make an enterprise economically feasible.

An additional potential finfish candidate for aquaculture at the NELH facility is the dolphin fish or mahi mahi (*Coryphaena*). The market potential for mahi mahi is well known in Hawaii and is increasing on the mainland, limited by supply from capture fisheries. It is estimated that the existing market for mahi mahi could be enlarged by two million pounds per year at the current price structure.

For a two million pounds per year operation, it is estimated that the total land area required is approximately ten acres, which includes production raceways, post hatchery tanks, intermediate tanks, hatchery broodstock, algae culture, and processing units. The total cold water flow requirements for this operation would be approximately 3,500 gpm with an additional 5,700 gpm of warm water required.

The capital costs of this operation are approximately \$2.85 million. It is estimated conservatively that a market price of \$1.90 to \$2.10 per pound of fish could be realized. At this level, a very attractive return on investment is possible.

MODULAR SYSTEMS

A variety of combinations of the above aquaculture operations would be possible at NELH/HOST Park. These systems could be run in tandem, by rearing the more cold tolerant and/or pure cultures first, then running the water to the open pond areas. If necessary, water quality could be enhanced with some biological filtration. Polyculture opportunities also exist. Shrimp have been cultured in Taiwan in ponds of *Crassilaria*. Mollusks have been cultured on the bottom of fish and shrimp ponds.

SUMMARY AND CONCLUSIONS

Several of the species discussed present opportunities for the State of Hawaii in two ways. First, there are R & D operations that could be conducted at the NELH facility on a commercial basis, perhaps taking the form of R & D branches of existing or

future aquaculture companies based in Hawaii (or elsewhere). Or, second, the NELH site itself could support commercial growth operations that evolve from and/or are supported by the R & D operations themselves. There are spillover or spinoff ventures (that could evolve from NELH-based aquaculture R & D operations) to the adjoining HOST Park which should be considered and, indeed, the two entities will be mutually supportive and synergistic. The availability of nutrient rich cold water and/or the warmer surface waters are assets that make the NELH site unique. There are no known facilities elsewhere that have the existing and planned flow capacities of the NELH/HOST sites. (See the section on competition.)

The crucial factor in commercially developing both NELH aquaculture and the HOST Park aquaculture will be the actual cost of cold and warm water delivered to the respective sites. These costs will substantially affect the potential profitability of ventures at either operation.

Recommendations

The Keahole facilities present a unique opportunity for the State of Hawaii. The next step in determining the specific marketability of the site will be a more detailed design and market analysis. The market analysis must be conducted in concert with more detailed analysis and compilation of projected tenant use charges for water, land costs or rent, processing facilities, etc. With this information, a market test survey can be conducted during the next design phase.

A package of cost and services should be prepared early in the design phase. This information would be taken to a number of investor groups and aquaculture firms for presentation and review. Personal interviews with at least five of the ten groups expected to be interested should be conducted to ascertain the actual level of investor and/or operator interest in the new facility.

Based on experience in dealing with investor groups interested in aquaculture, it is believed that strong interest will be expressed, conditioned, of course, on the projected operating costs and services that would be implemented. The most critical aspect of test marketing will be the availability of solid and credible evidence that there is a firm commitment on the part of the state to implement the required cold water pipe expansion and that the user charges are firmly established.

In this light, it is further recommended that HOST consider the possibility of a central processing facility for the facilities. Depending on the exact mix of uses, it may be effective and attractive to have a central processing facility that would accept fish and/or algal products from the tenants to be processed in various ways. It is difficult to specify the exact nature of such a facility, but certain advantages in economies of scale, operational costs and shipping may be possible. This facility could be run privately or as a cooperative effort between the HOST Park and the tenants.

Competition to the NELH/HOST Facilities

The facilities planned for the NELH/HOST Park are certainly unique and offer potential benefits to aquaculture developers and operators. The existence of the cold

water pipe and the availability of deep water areas close to shore are attractive assets to the concept.

The only other cold water pipe facility that has been operated for aquaculture purposes, that is known is in St. Croix, the Virgin Islands in the Caribbean. A private concern, Maritec, operated a cold water withdrawal for brine and penaeid shrimp culture development in the 1970s. This work was discontinued several years ago, reportedly due to insufficient funds. No other references to similar facilities could be found. Puerto Rico has interests and activities in OTEC technology, but no reference to tying this technology into an aquaculture facility such as is proposed by NELH could be found.

It should be noted, however, that OTEC technology being developed and funded by USDOE has attracted interest worldwide, particularly in third world countries. If a successful aquaculture park facility is developed at Keahole Point, it seems probable that this same technology, relatively available to anyone, will be considered by those countries where deep water is close to shore. There are many such locations. This possibility is the primary competitive factor, but it is not judged critical, depending upon the development at Keahole Point. If the HOST Park is successful and fills up relatively rapidly, the emergence of other similar installations will not obviously adversely affect the NELH or HOST Park programs. Once aquaculture firms and operations are in place and operating successfully, they will probably remain, given attractive fee structures for occupancy and infrastructure, including the cold water.

SUMMARY TABLE OF OTEC AQUACULTURE ALTERNATIVES

TYPE OF CULTURE	SPECIES	AREA REQUIRED	WATER DEMAND	PRODUCTION RATE	SELLING PRICE	TYPE OF OPERATION			
ALGAE	Phytoplankton	2.5 acres	130 - 370 gpm (ponds)	1.1 - 5.5 tons/day	Determined locally	Ponds			
			950 - 1800 gpm (raceway)			Raceways			
	Macro-algae	25 acres	5,000 - 10,000 gpm	100 tons/yr (dried plant mat'l)	\$700-\$1,000/ton	Raceways			
				6.6 lbs/day (micrograde agar)*	\$90 - \$125/lbs				
				100 tons/yr (dried plant mat'l)	\$700-\$1,000/ton				
Laminaria	100 tons/yr (dried plant mat'l)	\$700-\$1,000/ton							
CRUSTACEANS	Brine Shrimp	Artemia	10.5 acres	23,600 - 30,400 gal/wk	520 - 670 lbs/wk	\$10/lbs	Raceways		
	Marine Shrimp	P. Vannamei P. Stylirostris	0.5 acres	100 gpm	10,00,000 pls/3 wks	\$10 - \$30/1,000 pls	Hatchery		
MOLLUSKS	Clams	Mercenaria	1,000 gpm	1,000,000 clams/acre/yr	\$0.07 - \$0.10/clam**	Raceways			
				2,000,000 clams/acre/yr					
	Oysters	6.25 acres Crassostrea Ostrea	400 gpm	800,000 oysters/acre/yr	\$0.05 - \$0.07/oyster				
FINFISH	Mullet	25 acres	500 - 1,000 gpm	880 lbs/acre/yr	Determined locally	Ponds			
				White Bass Dolphin (mahi-mahi)	0.25 acres	100 gpm	500,000 - 1,000,000 fingerlings/year	\$0.25 - \$0.50/fnglng	Hatchery
							Mahi-mahi	10 acres	3,500 gpm (cold) 5,700 gpm (warm)

* Extrapolated from experiments to commercial scale
 ** East Coast Values

APPENDIX B

**TECHNICAL EVALUATION OF PROPOSED
PIPELINES AT NELH/HOST PARK**

**EDWARD K. NODA & ASSOCIATES
JUNE 1985**

1. TECHNICAL EVALUATION OF THE BOUNDARIES OF THE CONCEPTUAL USE OCEAN CORRIDOR:

The primary technical considerations for establishing the boundaries of the Conceptual Use Ocean Corridor (CUOC) are the potential ocean water requirements for NELM and the HOST Park, and the most cost efficient routing of the water to the users. Figure 1-1 shows the present ocean research corridor offshore NELM and the proposed CUOC encompassing the NELM and HOST Park ocean frontage. The following discusses the reasons for establishing the proposed northern, southern and offshore boundaries of the CUOC.

a. Northern Limit. The deep water bottom contours offshore the site run in approximately a NNW-SSE alignment. Since the shoreline north of Keahole Point curves towards the NE, the distance from shore to deep cold water (at least 2,000 ft depth) increases substantially as you get further north from the point. The cold water offshore pipe carries the largest risk and cost of any component of the cold water supply system, and therefore it is desirable to minimize the CWP offshore length. The warm water offshore pipe does not have this constraint, since the intake is located nearshore in relatively shallow water (less than 100-ft depth). For the WWP, it is desirable to minimize the overland pumping distance to the users. Any potential ocean water discharge pipe would also be located as close to users as possible to minimize overland construction costs. Thus, while it is unlikely that a future CWP will be sited beyond the present northern boundary of the ocean corridor, we do not wish to preclude the potential siting of a WWP or ocean water discharge pipe servicing potential users located north of the present NELM facilities. In addition, possible future projects which require ocean frontage (such as wave energy conversion) are more desirably accommodated north of Keahole Point to prevent infringement on the beach areas and potential CWP routes south of Keahole Point. For these reasons, it is recommended that the northern CUOC limit at the coast be located approximately 4,500 feet NE of the present northern corridor boundary.

b. Southern Limit. Between Keahole Point and the HOST Park, the distance from shore to deep cold water at the 2,000 foot depth increases slightly as you get further south from the point. The estimated offshore cold water pipe length for a CWP route directly fronting the HOST Park is approximately 2,000 feet longer than for a CWP route from Keahole Point. A preliminary cost evaluation between the two CWP routes for a supply system to the HOST Park indicated that the order of magnitude costs for both routes were approximately the same. While the overland pipe length was approximately 7,000 feet less for the HOST Park route than for the Keahole Point route, the additional 2,000 feet of offshore pipe for the HOST Park route was a significant offsetting factor. A CWP route directly offshore the HOST Park would probably require

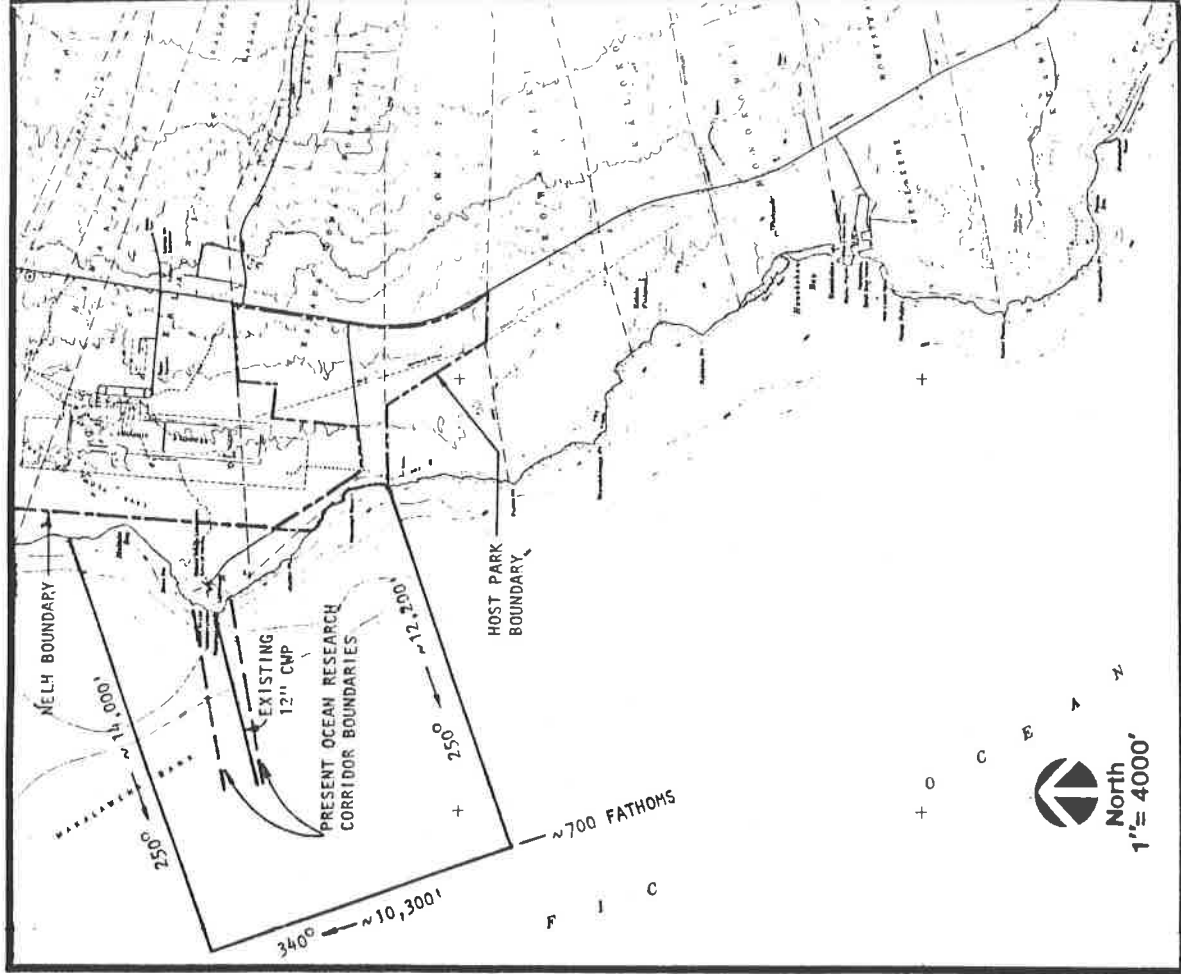

Fig. 1-1. PROPOSED BOUNDARIES OF THE CONCEPTUAL USE OCEAN CORRIDOR

2. EVALUATION OF THE OTEC MIXED-WATER DISCHARGE PLUME FROM THE PROPOSED DOE, SERI MAJOR MODIFICATIONS PROJECT AT NELH:

Based on the available information to date, the following parameters have been established for the project:

Cold water intakes: Volume rate, $Q=6,500$ gpm
Intake depth $\approx 2,000$ feet
Pipeline length $\approx 6,000$ feet

Warm water intakes: Volume rate, $Q=9,500$ gpm
Intake depth ≈ 40 feet
Pipeline length $\approx 1,500$ feet

Mixed-Water Discharge: Volume rate, $Q=16,000$ gpm
Discharge depth ≈ 200 feet
Pipeline length $\approx 1,600$ feet

The behavior of the mixed-water discharge plume was predicted using a near-field plume model which was developed to describe the potential impacts from a proposed 40 MW OTEC Pilot Plant offshore Kahe Point, Oahu (Koh et al, 1984). A 48 inch diameter discharge pipe was assumed for this evaluation, based on the conceptual design. The mixed-water discharge temperature and salinity are assumed to be proportional to the combined cold water and warm water intake characteristics. The cold water temperature and salinity vary little throughout the year. Based on measured data from the existing NELH 12 inch diameter cold water pipe, the temperature ranged from a minimum of 9.5 degrees C to a maximum of 10.5 degrees C. An average value of 10 degrees C is used for this evaluation. The cold water salinity range was 34.27 ‰ to 34.37 ‰, with an average of 34.31 ‰ used in this evaluation. The warm water temperature and salinity exhibit greater variability due to the seasonal differences in solar heating and rainfall, and the influence of the near-surface currents. Temperature and salinity data collected south of Keahole Point for the proposed Kailua-Kona Northern Zone Sewerage System ocean outfall (Sea Engineering, Inc., 1985) were used as a basis for evaluating the plume characteristics under typical ambient conditions. For any given temperature/salinity profile, the warm water parameters at the 40-foot depth were used in the determination of the mixed water discharge parameters for that particular plume evaluation.

The mixed-water discharge plume, being colder and therefore denser than ambient waters at the 200-foot depth of discharge, would remain submerged. The initial momentum-dominated plume would flow along the bottom until reaching the equilibrium density with the surrounding water, whereupon the plume will spread laterally and be advected away from the area by the nearshore currents. The considerations are the depth and excursion of the plume prior to reaching ambient density. Due to the depth of discharge at 200 feet, there is

relatively more construction activity in nearshore waters than a CMP route off Keahole Point, since the shallow water zone offshore the HOST Park is wider than off Keahole Point and hence may require more trenching and excavation work. However, since detailed bathymetry is not yet available offshore the HOST Park, estimated offshore CMP costs are very conceptual. It is possible that detailed offshore surveys may identify favorable route(s) for the CMP south of Keahole Point resulting in lower overall construction costs. Another consideration for future CMP's is the limitation on the maximum number of pipes which can be placed within the sand channel offshore Keahole Point, which serves as the existing 12 inch CMP route through an area of large basalt outcroppings and boulders at the 300-400 foot shelf break. It is anticipated that two future pipelines, in addition to the planned 15 inch pipeline for Hawaiian Abalone Farms and the planned 30 inch Department of Energy CMP, can safely be accommodated within this sand channel route. Any additional CMP's may need to be routed south of this area due to the increased risk of potential damage to the already existing pipelines. Also, a WMP system serving the HOST Park would probably be located south of Keahole Point to minimize onshore pipeline and pumping costs. Therefore, it is recommended that the southern CUOC limit be located at the southern property boundary of the HOST Park at the coast.

c. Azimuths of Northern and Southern CUOC Boundaries From Shore. Generally, the shortest route to the required depth is desired for offshore pipelines. This typically results in pipelines being aligned perpendicular to the bottom contours. Also, for pipelines laid directly on the ocean bottom, an alignment which is not perpendicular to the bottom contours results in lateral forces on the pipe causing it to want to slide or roll sideways down the slope unless restrained. Thus, the recommended azimuth from shore for the northern and southern CUOC boundary is 250°T, perpendicular to deepwater contours.

d. Offshore Limit. The need for sufficiently low ocean water temperatures for OTEC and cold water aquaculture (8-10 degrees C) is the governing criteria for the minimum offshore limit of the CUOC. This cold water source is available at nominal depths of 2,000 feet or more. In addition, potential future projects which may require the mooring of platforms or facilities offshore (such as floating OTEC or desalination pilot plants) will need to be located sufficiently seaward of the pipelines. Therefore, the offshore limit of the CUOC roughly parallels the deepwater contours at the approximate 700 fathom (4,200 foot) depth. From an offshore distance of approximately 2.3 miles along the southern CUOC boundary azimuth, the recommended offshore boundary azimuth is 340°T northward to the point of intersection with the northern CUOC boundary, a distance of approximately 2 miles.

little potential for degradation of the warm water intake source at 40-foot depth. However, depending on the maximum equilibrium depth of the plume, there may be some potential for degrading the cold water source, however slight. Therefore, this evaluation was accomplished to determine the potential maximum, as well as minimum, depth of plume submergence.

Table 2-1 summarizes the results for cases under two typical density profiles of offshore waters, depicting potential maximum depth of plume submergence (winter) and potential minimum depth of plume submergence (summer). The maximum excursion of the plume in the offshore direction occurs for the condition when the alongshore current speed is zero. When a current field is imposed, the plume is carried alongshore with the currents, and generally reaches ambient density at shallower depths and more quickly with greater current speeds. A typical maximum alongshore current speed of 1.5 ft/sec (0.9 knots) was used in this evaluation to provide an indication of the magnitude of alongshore excursion of the plume. Figures 2-1 through 2-4 graphically depict the mixed-water plume characteristics for the cases summarized in Table 2-1.

For each case, four individual figures are shown (a-d), depicting the spatial and physical parameters of the plume:

- (a) shows the offshore excursion distance (X-direction) of the plume as it sinks to its "free" equilibrium depth, assuming that the plume was not constrained by the ocean bottom. The ocean bottom is depicted by the double chained line. Also shown on the figure is the Sigma-t density profile of the ambient waters.
- (b) shows how the plume might probably flow along the ocean bottom until reaching equilibrium depth, since in reality the ocean bottom constrains the plume from sinking to its "free" equilibrium depth as depicted in (a). The plume is simply redrawn by fitting its characteristics at depth to the corresponding X-location along the bottom profile, and does not represent an analytical solution to the real bottom-constrained situation.
- (c) shows the alongshore excursion distance of the plume in which the current is moving in the positive Y-direction. The distance, S, is the lineal distance along the plume centerline. This output represents the plume behavior assuming no interaction with the ocean bottom.
- (d) shows the parameters of depth (Z), time (T), speed (U), and concentration (C) at the plume centerline as a function of the offshore excursion distance of the plume. This output represents the plume parameters assuming no interaction with the ocean bottom. The arrows point to the values at equilibrium density.

Table 2-1
Summary Results for Mixed-Water Discharge Plume
Under Typical Extreme Ambient Density Conditions

Figure no.	Case 1	Case 2	Case 3	Case 4
Profile no. <1>	2-1	2-2	2-3	2-4
Profile date <1>	4 2/6/84	18 7/20/84	4 2/6/84	18 7/20/84
Discharge Temperature (°C)	19.0	19.4	19.0	19.4
Discharge Salinity (‰)	34.62	34.34	34.62	34.34
Alongshore Current Speed (ft/sec)	0	0	1.5	1.5
CL Plume Depth at Ambient Density (ft)	-382	-259	-358	-247
Time for Plume to Reach Ambient Density (sec)	180	70	110	40
CL Plume Velocity at Ambient Density (ft/sec)	1.01	1.27	1.69	1.86
CL Plume Alongshore Excursion Distance from Point of Discharge (ft)	0	0	71	17
CL Plume Concentration at Ambient Density	.072	.181	.021	.069
CL Plume Dilution at Ambient Density	13:1	5:1	47:1	14:1

<1> Ambient temperature/salinity profiles from Station 3 offshore Kealahoe in 450-foot water depth (from Sea Engineering, 1985)

DATA
 PROFILE 84: S1R, 3: 430 FEET:2-6-84
 CURRENT SPEED 1 0.00 (F/2S)
 DEPTH OF DISCHARGE 1 196.50 (FEET)
 DISCHARGE RATE 1 196.50 (MG/D)
 DISCHARGE RATE 1 35.63 (F/2S)
 DISCHARGE RATE 1 23.84 (MG/D)
 PIPE DIAMETER 1 4.00 (FEET)
 DISCHARGE ANGLE 1 19.00 (DEGREES)
 DISCHARGE TEMPERATURE 1 66.28 (DEG. F)
 DISCHARGE SALINITY 1 34.619 (g/100)
 DISCHARGE DENSITY 1 6.6782
 NOTE: * UNIFORM CURRENT IN Y-DIRECTION
 * VERTICAL ANGLE MEASURED FROM Y TO Z

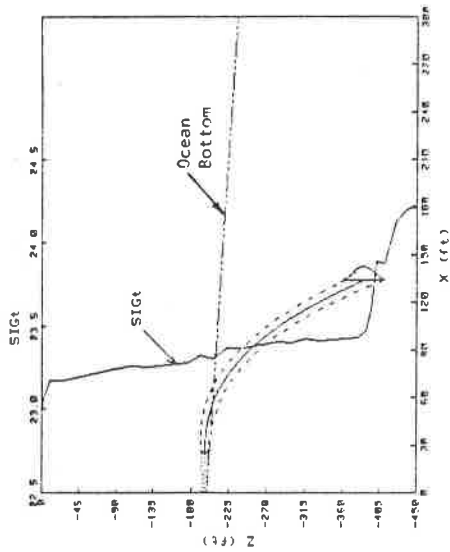

(a)
 Offshore excursion of plume (not constrained by ocean bottom)

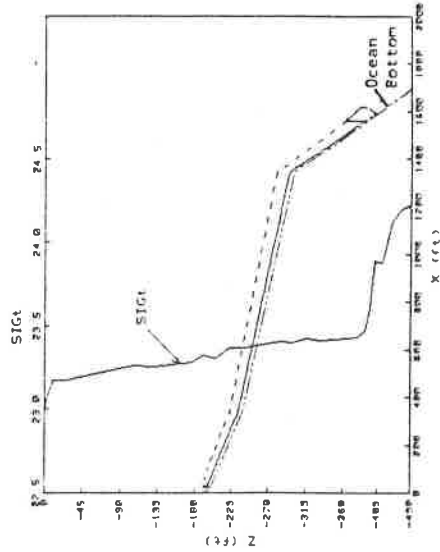

(b)
 Offshore excursion of plume (constrained by ocean bottom)

DATA
 PROFILE 84: S1R, 3: 450 FEET:2-6-84
 CURRENT SPEED 1 0.00 (F/2S)
 DEPTH OF DISCHARGE 1 196.50 (FEET)
 DISCHARGE RATE 1 196.50 (MG/D)
 DISCHARGE RATE 1 35.63 (F/2S)
 DISCHARGE RATE 1 23.84 (MG/D)
 PIPE DIAMETER 1 4.00 (FEET)
 DISCHARGE ANGLE 1 19.00 (DEGREES)
 DISCHARGE TEMPERATURE 1 66.28 (DEG. F)
 DISCHARGE SALINITY 1 34.619 (g/100)
 DISCHARGE DENSITY 1 6.6782
 NOTE: * UNIFORM CURRENT IN Y-DIRECTION
 * VERTICAL ANGLE MEASURED FROM Y TO Z

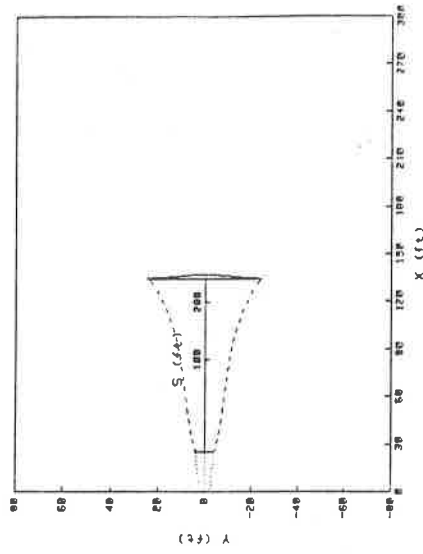

(c)
 Alongshore excursion of plume (not constrained by ocean bottom)

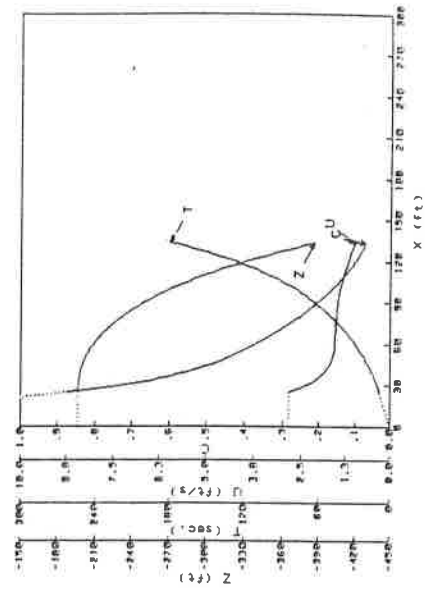

(d)
 Plume parameters (not constrained by ocean bottom)

Fig. 2-1. PREDICTED MIXED-WATER DISCHARGE PLUME FROM THE DEPT. OF ENERGY OTEC PROJECT; POTENTIAL MAXIMUM DEPTH OF SURGERNCE WITH NO CURRENTS

Fig. 2-1. PREDICTED MIXED-WATER DISCHARGE PLUME FROM THE DEPT. OF ENERGY OTEC PROJECT; POTENTIAL MAXIMUM DEPTH OF SURGERNCE WITH NO CURRENTS

DATA PROFILE NO.: STA 3: 400 FEET; 7:20.04

CURRENT SPEED	0.80 (F.S)
DEPTH OF DISCHARGE	196.50 (FEET)
DISCHARGE SPEED	35.63 (MG/S)
DISCHARGE RATE	23.84 (MG/S)
PIPE DIAMETER	4.00 (FEET)
VERTICAL DISCHARGE ANGLE	0.00 (DEG/EE)
DISCHARGE TEMPERATURE	67.81 (DEG. F)
DISCHARGE SALINITY	34.342 (P.P.T)
JET NEUMATIC PROBE NO.	6.0204

NOTE: * UNIFORM CURRENT IN Y-DIRECTION
 * VERTICAL ANGLE MEASURED FROM Y TO Z

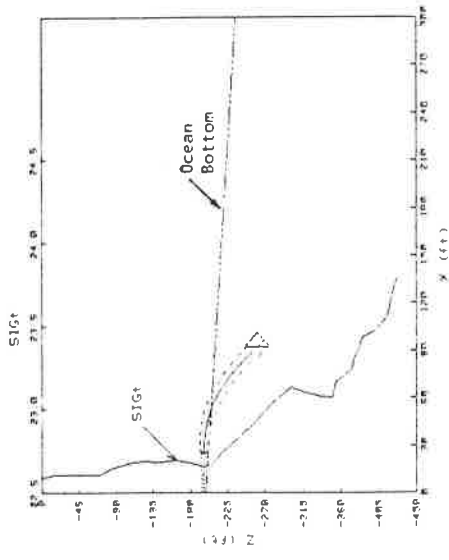

(a) Offshore excursion of plume (not constrained by ocean bottom)

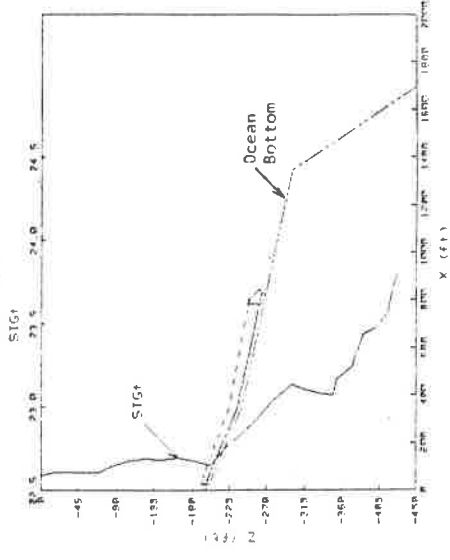

(b) Offshore excursion of plume (constrained by ocean bottom)

DATA PROFILE NO.: STA 3: 400 FEET; 7:20.04

CURRENT SPEED	0.80 (F.S)
DEPTH OF DISCHARGE	196.50 (FEET)
DISCHARGE SPEED	35.63 (MG/S)
DISCHARGE RATE	23.84 (MG/S)
PIPE DIAMETER	4.00 (FEET)
VERTICAL DISCHARGE ANGLE	0.00 (DEG/EE)
DISCHARGE TEMPERATURE	67.81 (DEG. F)
DISCHARGE SALINITY	34.342 (P.P.T)
JET NEUMATIC PROBE NO.	6.0204

NOTE: * UNIFORM CURRENT IN Y-DIRECTION
 * VERTICAL ANGLE MEASURED FROM Y TO Z

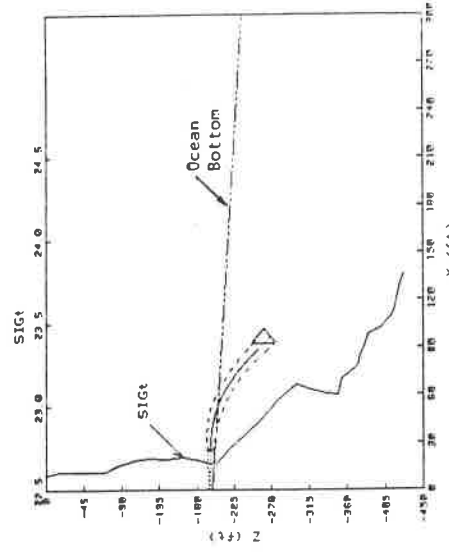

(a) Offshore excursion of plume (not constrained by ocean bottom)

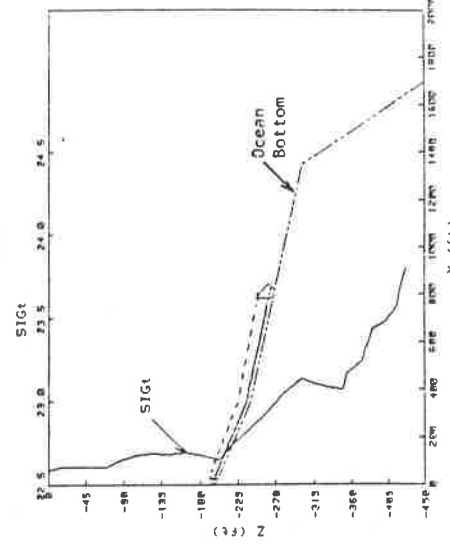

(b) Offshore excursion of plume (constrained by ocean bottom)

Fig. 2-2. PREDICTED MIXED-WATER DISCHARGE PLUME FROM THE DEPT. OF ENERGY OTEC PROJECT; POTENTIAL MINIMUM DEPTH OF SUBMERGENCE WITH NO CURRENTS

Fig. 2-2. PREDICTED MIXED-WATER DISCHARGE PLUME FROM THE DEPT. OF ENERGY OTEC PROJECT; POTENTIAL MINIMUM DEPTH OF SUBMERGENCE WITH NO CURRENTS

DATA
 PROFILE NO.: STA 31: 400 FEET: 7-20-84
 CURRENT SPEED : 0.00 (F/S)
 DEPTH OF DISCHARGE : 196.50 (FEET)
 DISCHARGE SPEED : 2.04 (F/S)
 DISCHARGE RATE : 23.84 (MGD)
 PIPE DIAMETER : 4.00 (FEET)
 VERTICAL DISCHARGE ANGLE : 0.00 (DEG/F)
 DISCHARGE TEMPERATURE : 19.25 (DEG. F)
 DISCHARGE SALINITY : 67.01 (P.P.T)
 JET DENSIMETRIC FROUDE No. : 34.342 (G.G.)
 NOTE: * UNIFORM CURRENT IN Y-DIRECTION
 * VERTICAL ANGLE MEASURED FROM Y TO Z

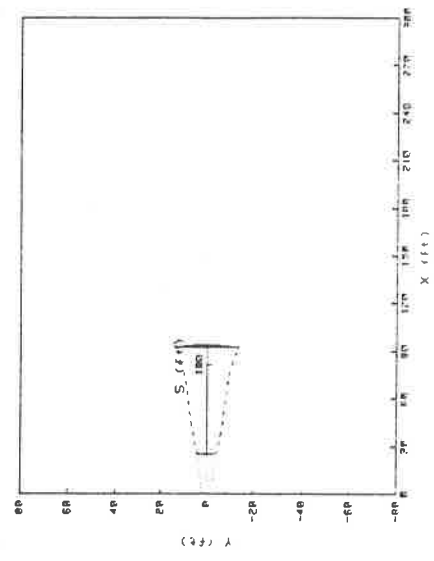

(c)
 Alongshore
 excursion of
 plume (not
 constrained by
 ocean bottom)

DATA
 PROFILE NO.: STA 31: 400 FEET: 2-6-84
 CURRENT SPEED : 1.50 (F/S)
 DEPTH OF DISCHARGE : 196.50 (FEET)
 DISCHARGE SPEED : 2.04 (F/S)
 DISCHARGE RATE : 23.84 (MGD)
 PIPE DIAMETER : 4.00 (FEET)
 VERTICAL DISCHARGE ANGLE : 0.00 (DEG/F)
 DISCHARGE TEMPERATURE : 19.25 (DEG. F)
 DISCHARGE SALINITY : 67.01 (P.P.T)
 JET DENSIMETRIC FROUDE No. : 34.619 (G.G.)
 NOTE: * UNIFORM CURRENT IN Y-DIRECTION
 * VERTICAL ANGLE MEASURED FROM Y TO Z

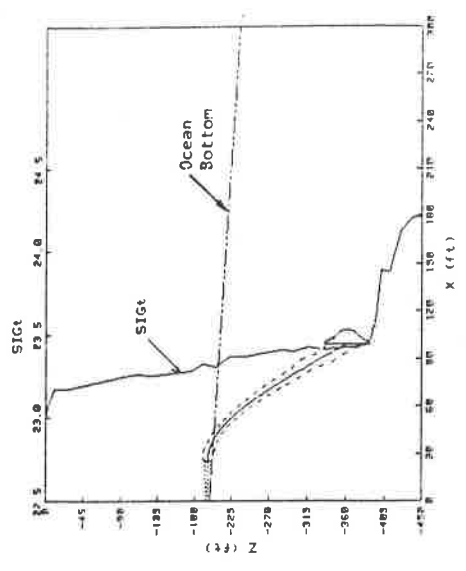

(a)
 Offshore
 excursion of
 plume (not
 constrained by
 ocean bottom)

DATA
 PROFILE NO.: STA 31: 400 FEET: 7-20-84
 CURRENT SPEED : 0.00 (F/S)
 DEPTH OF DISCHARGE : 196.50 (FEET)
 DISCHARGE SPEED : 2.04 (F/S)
 DISCHARGE RATE : 23.84 (MGD)
 PIPE DIAMETER : 4.00 (FEET)
 VERTICAL DISCHARGE ANGLE : 0.00 (DEG/F)
 DISCHARGE TEMPERATURE : 19.25 (DEG. F)
 DISCHARGE SALINITY : 67.01 (P.P.T)
 JET DENSIMETRIC FROUDE No. : 34.342 (G.G.)
 NOTE: * UNIFORM CURRENT IN Y-DIRECTION
 * VERTICAL ANGLE MEASURED FROM Y TO Z

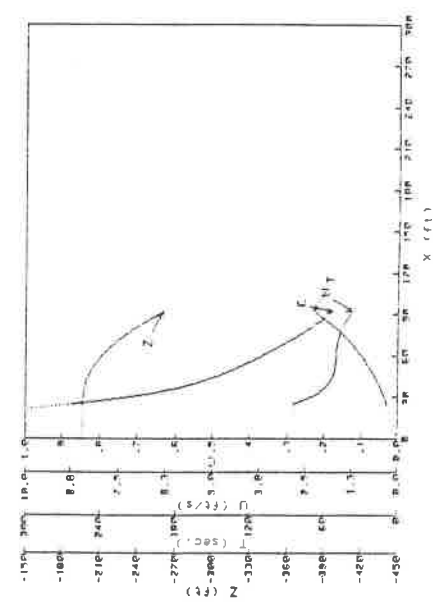

(d)
 Plume
 parameters
 (not con-
 strained by
 ocean bottom)

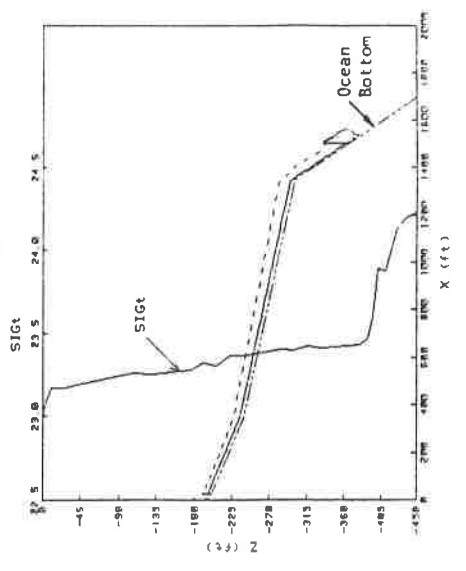

(b)
 Offshore
 excursion of
 plume (con-
 strained by
 ocean bottom)

Fig. 2-2. PREDICTED MIXED-WATER DISCHARGE PLUME FROM THE DEPT. OF ENERGY OTEC PROJECT; POTENTIAL MINIMUM DEPTH OF SUBMERGENCE WITH NO CURRENTS

Fig. 2-3. PREDICTED MIXED-WATER DISCHARGE PLUME FROM THE DEPT. OF ENERGY OTEC PROJECT; POTENTIAL MAXIMUM DEPTH OF SUBMERGENCE WITH 0.9 KNOT ALONGSHORE CURRENT

DATA PROFILE #4: STA. 7: 450 FEET; 2-6-84

CURRENT SPEED	1.30 (F/S)
DEPTH OF DISCHARGE	196.50 (FEET)
DISCHARGE SPEED	2.84 (F/S)
DISCHARGE RATE	23.84 (MG/D)
PIPE DIAMETER	4.80 (FEET)
VERTICAL DISCHARGE ANGLE	0.00 (DEG. C)
DISCHARGE TEMPERATURE	62.28 (DEG. F)
DISCHARGE SALINITY	34.619 (P.P.T)
JET METEORIC PROBE NO.	3-1472

NOTE: * UNIFORM CURRENT IN Y-DIRECTION
 * VERTICAL ANGLE MEASURED FROM Y TO Z

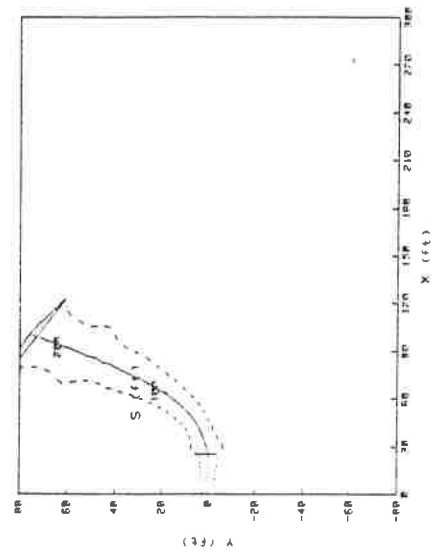

(c) Alongshore excursion of plume (not constrained by ocean bottom)

DATA PROFILE #19: STA. 31: 400 FEET; 2-20-84

CURRENT SPEED	1.30 (F/S)
DEPTH OF DISCHARGE	196.50 (FEET)
DISCHARGE SPEED	35.65 (F/S)
DISCHARGE RATE	23.84 (MG/D)
PIPE DIAMETER	4.80 (FEET)
VERTICAL DISCHARGE ANGLE	19.45 (DEG. C)
DISCHARGE TEMPERATURE	67.81 (DEG. F)
DISCHARGE SALINITY	34.342 (P.P.T)
JET METEORIC PROBE NO.	2-8372

NOTE: * UNIFORM CURRENT IN Y-DIRECTION
 * VERTICAL ANGLE MEASURED FROM Y TO Z

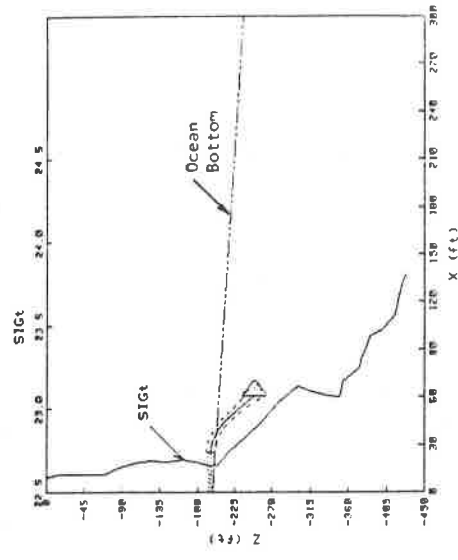

(a) Offshore excursion of plume (not constrained by ocean bottom)

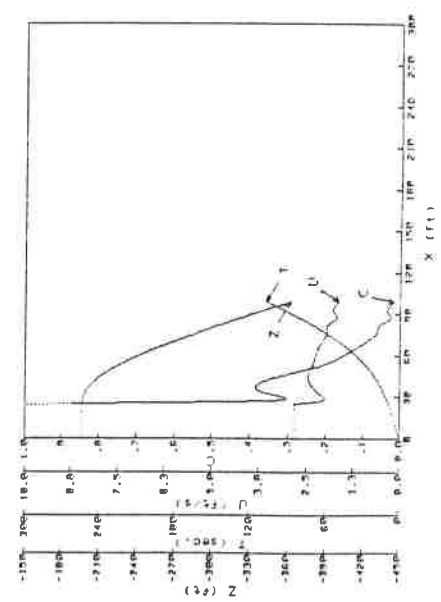

(d) Plume parameters (not constrained by ocean bottom)

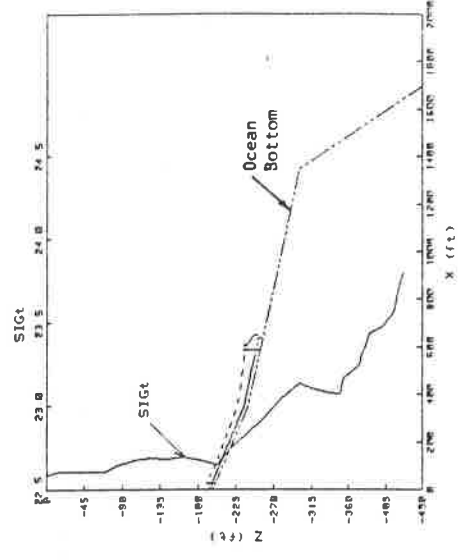

(b) Offshore excursion of plume (constrained by ocean bottom)

Fig. 2-4. PREDICTED MIXED-WATER DISCHARGE PLUME FROM THE DEPT. OF ENERGY OTEC PROJECT; POTENTIAL MINIMUM DEPTH OF SUBMERGENCE WITH 0.9 KNOT ALONGSHORE CURRENT

Fig. 2-3. PREDICTED MIXED-WATER DISCHARGE PLUME FROM THE DEPT. OF ENERGY OTEC PROJECT; POTENTIAL MAXIMUM DEPTH OF SUBMERGENCE WITH 0.9 KNOT ALONGSHORE CURRENT

PROFILE BHP, STD. 3: 400 FEET; 7-20-84
 CURRENT SPEED 1.56 (F/S)
 DEPTH OF DISCHRG 196.30 (FEET)
 DISCHARGE SPEED 2.84 (F/S)
 DISCHARGE RATE 35.65 (C/S)
 PIPE DIAMETER 2.00 (FEET)
 VERTICAL DISCHARGE ANGLE 0.00 (DEGREES)
 DISCHARGE TEMPERATURE 19.45 (DEG. C)
 DISCHARGE SALINITY 34.742 (PPT)
 ZEE BATHYMETRIC PROFILE NO. 2-8722
 NOTE:
 * UNIFORM CURRENT IN X-DIRECTION
 * VELOCITY ONLY MEASURED FROM Y TO Z

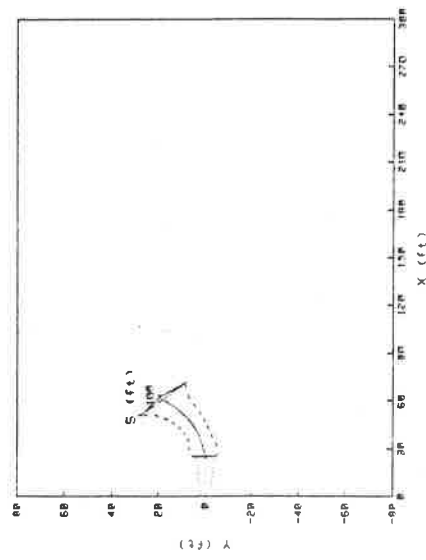

(c)
 Alongshore excursion of plume (not constrained by ocean bottom)

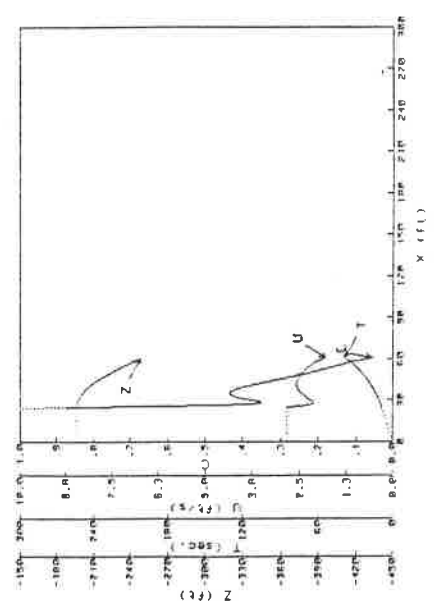

(d)
 Plume parameters (not constrained by ocean bottom)

The plume model was run for many more cases than are presented herein. However, only the extreme cases are included to show the probable minimum and maximum depths of plume submergence. The results indicate that the OTEC mixed-water discharge plume from the proposed DOE project at NELH will have little potential for impacting either the warm water intake sources or the cold water intake sources at Keahole Point and the HOST Park. The discharge plume is expected to remain on the shelf region at depths greater than 200 feet and shallower than 400 feet. Due to limitations of a numerical model, physical model tests are being undertaken to evaluate the plume characteristics and to determine the optimum discharge depth. Fig. 2-5 shows typical photographs of the plume in the model experiments.

Due to the existing and planned future pipelines in the area off Keahole Point, supporting both research and commercial operations, there is concern for the potential impacts of any discharge waters within the general area. While it is generally feared that strong alongshore currents may carry "pollutants" from an adjacent discharge source into the pristine intake source waters, it has been generally proven that the strong currents tend to quickly dilute and disperse the discharges due to greater turbulence and mixing. However, finite amounts of potential "pollutants" are advected with the currents, although their concentrations may be very dilute. The currents offshore Keahole Point and vicinity are dominated by two physical processes. The first is the astronomical tide, which drives reversing tidal currents with periods in the semi-diurnal and diurnal range. The second is the formation of large-scale eddies, which propagate out of the Alenuihaha Channel and influence the currents along the West Hawaii Coast. These eddy flows vary in strength and areal extent, however, they frequently dominate over the nearshore tidal currents and may persist for many days. Figures 2-6(a) and 2-6(b) show a continuous segment of current data from 5 October 1983 (1200 hrs) to 19 October 1983 (1200 hrs), from a current meter moored in water depth of 350 feet directly offshore Keahole Point. This current record is from an unpublished data set obtained by Edward K. Noda and Associates for the deployment of the 48 inch cold water pipe at Keahole Point, sponsored by the State of Hawaii through DPED and the Solar Energy Research Institute. The current sensor was located 50 feet below the water surface and recorded data once every 5 minutes. Each 5-minute data point is shown on the figures as a current vector, depicting the speed and direction towards which the current is flowing. Also included on the figures are the tidal height fluctuations. Figure 2-6(a) shows a typical eddy-dominated current flow. The larger eddy resulted in a persistent northward flow over a period of about 5 days, with maximum speeds of about 1.5 knots. This eddy then either dissipated or migrated out of the range of the current meter, and the following week (Figure 2-6(b)) was marked by the

Fig. 2-4. PREDICTED MIXED-WATER DISCHARGE PLUME FROM THE DEPT. OF ENERGY OTEC PROJECT; POTENTIAL MINIMUM DEPTH OF SUBMERGENCE WITH 0.9 KNOT ALONGSHORE CURRENT



(a) View of plume on bottom slope prior to reaching equilibrium

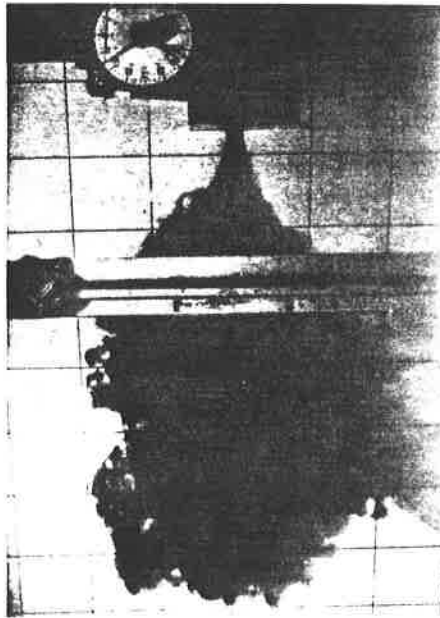

(b) Top view of plume showing horizontal spreading (no current)

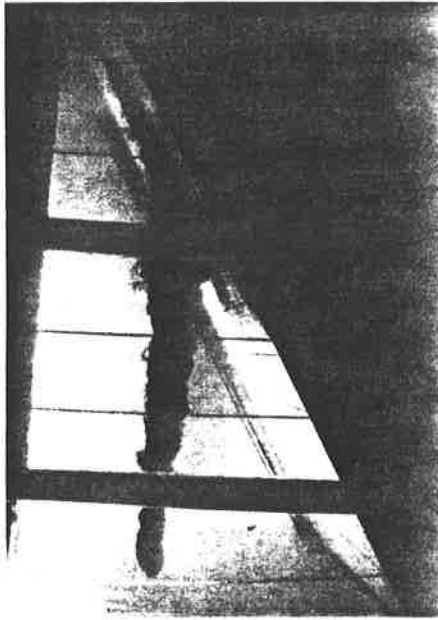

(c) View of plume at ambient density showing lateral spreading at equilibrium depth

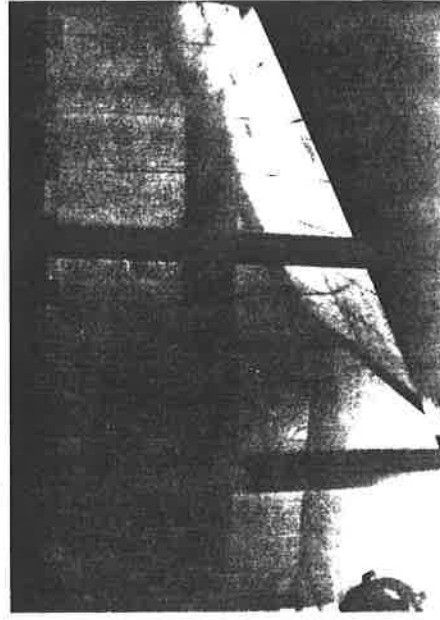

(d) Plume discharge within equilibrium layer

FIG. 2-5. TYPICAL PLUME CHARACTERISTICS FROM PHYSICAL MODEL TESTS (from Marine Sciences Group, Lawrence Berkeley Laboratory)

FIG. 2-5. TYPICAL PLUME CHARACTERISTICS FROM PHYSICAL MODEL TESTS (from Marine Sciences Group, Lawrence Berkeley Laboratory)

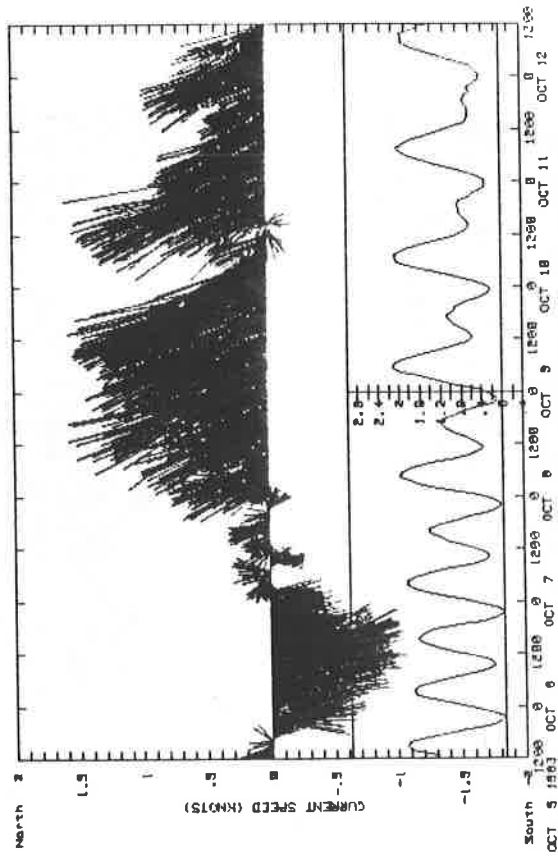

Current data from the 48' CWP deployment offshore Keahole Point, Hawaii obtained by Edward K. Noda & Associates. Data segment from 5 Oct 1983 (1200 hrs) through 12 Oct 1983 (1200 hrs).

Fig. 2-6(a). TYPICAL EDDY-DOMINATED CURRENTS OFFSHORE KEAHOLE POINT

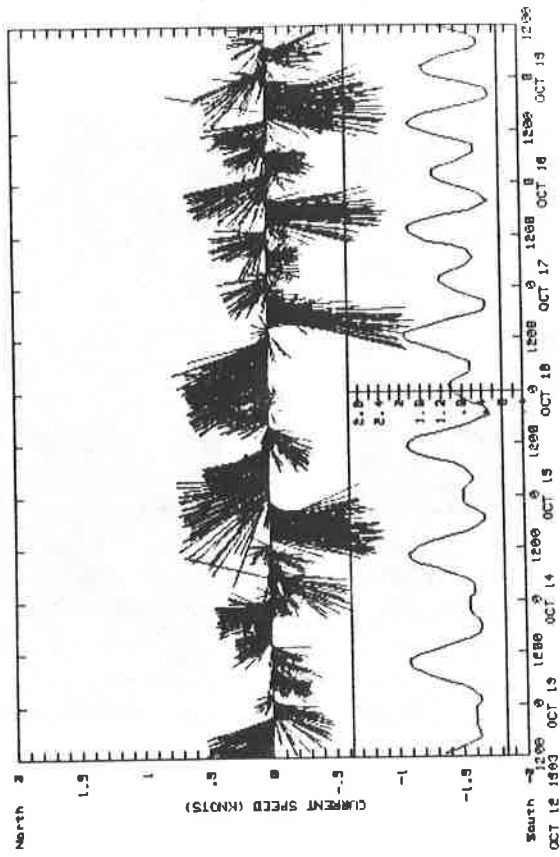

Current data from the 42' CWP deployment offshore Keahole Point, Hawaii obtained by Edward K. Noda & Associates. Data segment from 12 Oct 1983 (1200 hrs) through 19 Oct 1983 (1200 hrs).

Fig. 2-6(b). TYPICAL TIDAL CURRENTS OFFSHORE KEAHOLE POINT

reversing tidal currents, with typical maximum speeds of about 3/4 to 1 knot. Clearly, under a strong eddy flow situation, "pollutants" can be carried over great distances very quickly. A discrete particle being carried along at the same speed as a 1.5 knot current will travel over 40 miles in one day.

There are two reasons why the OTEC mixed water discharge plume would have little potential for impacting the nearsurface and deep intake source waters. One is the fact that the discharge water will contain no foreign "pollutants", except for very small amounts of chlorine which may be required to prevent biofouling of the heat exchangers. The second reason is the fact that the discharge, at a nominal depth of about 200 feet, would remain within some layer between the nearsurface warm waters and the deep cold waters. Once the plume reaches ambient density, since the scale of the horizontal motions is so much larger than the vertical motions, the discharged waters would be carried away from the area rather quickly.

While the chemical and biological implications of the mixed-water discharge were not evaluated in detail, the potential impacts are not expected to be significant. Provided that the intake waters are used solely for OTEC and not aquaculture activities, the discharge water will have no significant contaminants. The mixed-water discharge, however, will have slightly elevated levels of nutrients compared to the ambient waters at the 200-foot discharge depth, since the deep cold water has relatively higher nutrient levels compared to the nearsurface waters. From the plume model results, however, the dilutions at equilibrium density are adequate to reduce the mixed-water discharge concentrations of nutrients below Class AA criteria.

3. DESCRIPTIONS OF TYPICAL OFFSHORE CMP DESIGN AND CONSTRUCTION

The design and construction of cold water pipes (CMP) for either OTEC or cold water aquaculture purposes is, in general, conceptually based on the existing state-of-the-art of offshore pipeline construction. This state-of-the-art is primarily obtained from the offshore oil and gas industry, once-through cool water intake and discharge systems for power plants, and the design and construction of ocean wastewater disposal systems. While a viable history-base is available for offshore pipeline design and construction, there are substantial differences in the requirements for OTEC-related CMP's versus industry standard offshore pipelines. One of the most significant aspects of OTEC CMP's is their large diameters dictated by the large flow rate requirements. For example, oil and gas pipelines are in the 1-3 ft diameter range, wastewater outfalls are in the 3-12 ft diameter range, once-through power plant cooling water pipelines extend to 14 ft diameter, while proposed commercial scale OTEC cold water pipelines have been envisioned to 30 ft diameters.

Since only research or pilot scale OTEC projects are envisioned at NELH, the cold water flow requirements are significantly reduced such that CMP's in the range of 1-3 ft in diameter are anticipated. Maximum flow requirements for the NELH and HOST Park aquaculture projects are also anticipated to be satisfied by CMP's not exceeding 4 ft in diameter. These diameters now fall within the range of the present state-of-the-art for CMP design and construction.

In addition to diameter size, OTEC and cold water aquaculture pipelines are also unique in that the intake locations must be in very deep water in order to access the cold water resource. Thus, typical intake water depths in excess of 2,000 ft are generally required. Depending on the local bathymetry, the length of the pipeline required to reach these extreme depths can be substantial. For the Keahole Point region, the local bathymetry characteristics require pipeline lengths of at least 6,000 ft or longer in order to reach the desired cold water resource.

A further requirement of the CMP is that the cold water temperature must be preserved in order to utilize this resource onshore. For large diameter pipelines, insulation is generally not necessary due to the large volume of flow as compared to the circumferential pipeline surface area for heat transfer. For pipelines in the 1-4 ft diameter range, insulation considerations are necessary to insure the thermal resource at the onshore terminus. Finally, the cost of construction and/or deployment of the CMP is the most overriding factor in the economic feasibility of the use of this cold water resource. With these many constraints, the requirement for CMP's provides a very fertile region for unique and innovative designs as well as creative construction techniques. Without this special attention, the risks involved in CMP design and construction would be prohibitive. In fact, even with this special attention, the risks associated with CMP construction are much larger than with

conventional shoreside projects.

In the past decade, driven primarily by the OTEC research program, a great deal of study and research has been focused on CMP designs, although only one operational shore-based CMP has actually been constructed in the U.S.. This is the "Interim 12 inch Cold Water Intake" at NELH, Keahole Point, Hawaii. The other well known OTEC program called "Mini-OTEC" did utilize a 24 inch CMP, but this CMP was suspended from a floating platform and thus the design and construction techniques were vastly different than for a bottom mounted pipeline. The numerous OTEC CMP research studies previously undertaken have concentrated attention on the available state-of-the-art of other industrial pipeline designs and generally attempted to extend these essentially proven techniques to future CMP design. The difficulty with this approach is that the large diameters coupled with the very great water depth requirements clearly extend prototype commercial CMP designs considerably beyond the present state-of-the-art. Thus, significant extrapolations are required beyond the present state-of-the-art, and as a consequence, the estimated construction costs for commercial scale CMP's are very large and have a very high risk factor associated with general acceptability and validity.

To focus attention on the most probable type of cold water pipe design for future CMP's at Keahole Point, it is useful to describe in some detail the design and construction of the existing and uniquely operational 12 inch cold water intake system at NELH. In order to reduce the CMP construction cost, the design of the 12 inch CMP System involves very unique features. The selected pipeline material was high density polyethylene (HDP) which has excellent thermal insulating characteristics. Individual sections are easily joined using a fusing machine, and the strength characteristics of the pipe were sufficient to withstand deployment loads.

Intrinsic in the material selection was the special design of the pipeline to avoid bottom abrasion. Figure 3-1 describes the overall plan view of the 12 inch CMP design and Figure 3-2 shows the offshore elevation view. In order to avoid the possibility of damage and abrasion to the CMP, the pipeline was laid in a sandy bottom area between water depths of 200-500 ft as determined by a side scan sonar survey and submersible reconnaissance surveys. This sand channel offshore of Keahole Point provides a safe route for the CMP between rocky, high relief basalt areas. In this sandy region out to the 500 ft depth, the CMP was bottom mounted, with 500 lb concrete blocks anchoring the pipeline onto the ocean bottom. Beyond the sand channel in water depths greater than 600 ft, the offshore slope is very steep in the range of 35 degrees from horizontal, and submersible reconnaissance surveys indicate that large rock outcroppings and surface protrusions may occur along the CMP path. These surface geological features could easily damage a bottom mounted HDP pipe. Consequently, the 12 inch CMP design utilizes a unique catenary concept, where the pipeline transitions in the 500-foot water depth region from a bottom mounted pipeline to a floating, catenary design. HDP

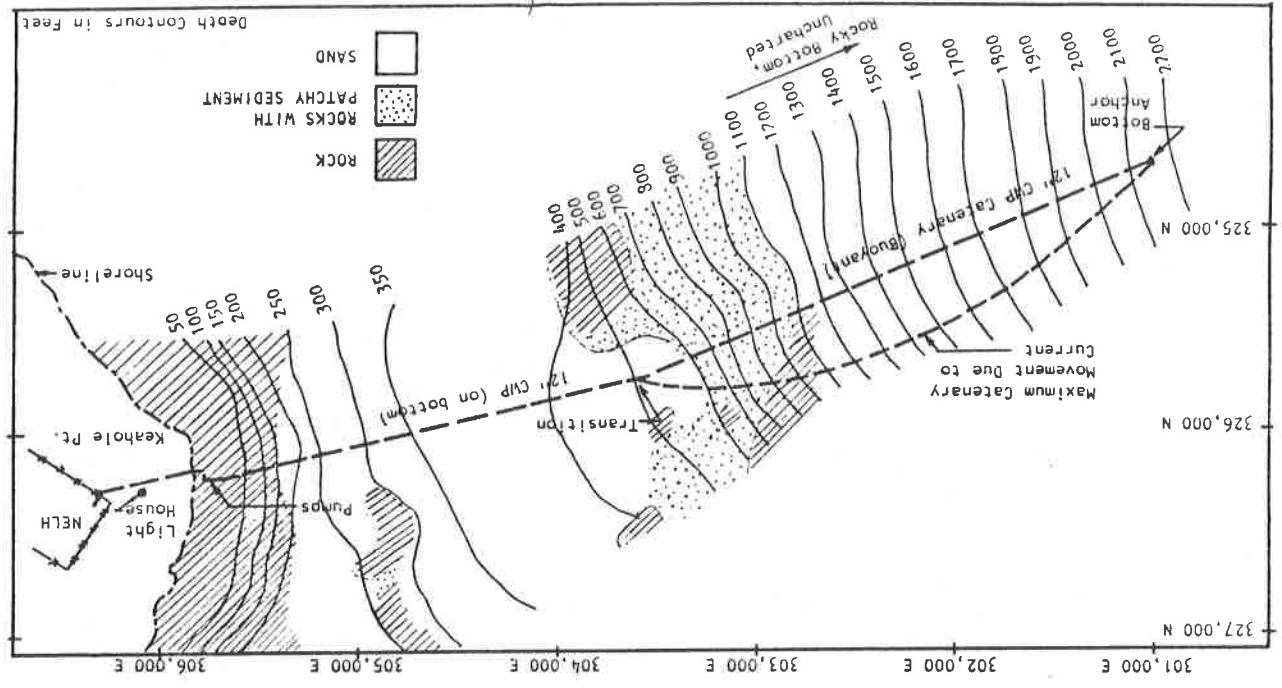

Fig. 3-1. PLAN VIEW OF THE 12-INCH COLD WATER PIPE AT NELH, KEAHOOLE POINT, HAWAII

material is less dense than water, and consequently its natural buoyancy is primarily used to lift the pipe off the bottom. Figure 3-2 provides a schematic description of the different characteristics of the bottom mounted and catenary portions of the 12 inch CWP.

The 12 inch offshore CWP was deployed in a two-day operation. During the first day, the bottom mounted section was deployed with the concrete anchor blocks attached to the pipe. This first section of pipe was about 3,200 ft long and was towed to the Keahole Point site from Kawaihae Harbor. During this towing operation, the pipeline was filled with air and capped at each end to provide buoyancy since the pipeline was already ballasted. Once the shoreward end was secured to the bottom, water was then pumped into this nearshore terminus, while air was vented from the offshore end. As the pipeline filled with water, the air-filled section of pipe remained on the surface while the water-filled end settled to the bottom, forming an "S" shape. In order to insure that the CWP did not exceed the allowable bending radius, tension was placed on the seaward end of the pipeline, which tended to stretch it out, thereby reducing the sharpness of the "S" shape. This pulling power was provided by tug boats, with the tension monitored by a running tensiometer. Figure 3-3 shows a sketch of the pipe-lowering operation. This initial bottom-mounted section was sufficiently long, such that it included part of the unballasted catenary section of the pipeline. Thus, the offshore end of the CWP remained on the surface.

The following day, the second section of the pipeline was towed from Kawaihae Harbor to Keahole Point to be joined with the offshore terminus of the initially deployed pipe section. This second section was 2,000 ft long, and since it was to be in the catenary section, it was not weighted. Thus, this section was towed to the site with both ends open. Once this second section was connected to the first section at the surface, water was again pumped through the pipeline, and the offshore end of the CWP was lowered to the bottom using three 3,000 lb anchors. Figure 3-4 shows the deployment of this catenary pipe segment.

It is noted that the catenary design clearly isolates the HDP pipe from possible abrasions and damage due to unknown rock protrusions on the offshore slope. In addition, the very rapid deployment operation for such a unique design provides a major cost saving factor, since typical daily at-sea operational costs are in the range of \$50,000/day or greater.

Another typical method for deploying offshore pipelines is to join the pipe sections at the intended site and subsequently pull the pipeline from shore into the water along the anticipated route. This requires that there be substantial area onshore where the pipe sections can be laid perpendicular to the coast. Usually, individual lengths of pipe are arranged in parallel strings on shore, in line with the intended offshore route. The pipeline is then pulled out segment by segment using barges or tug boats. As the initial segment is pulled offshore, it is stopped

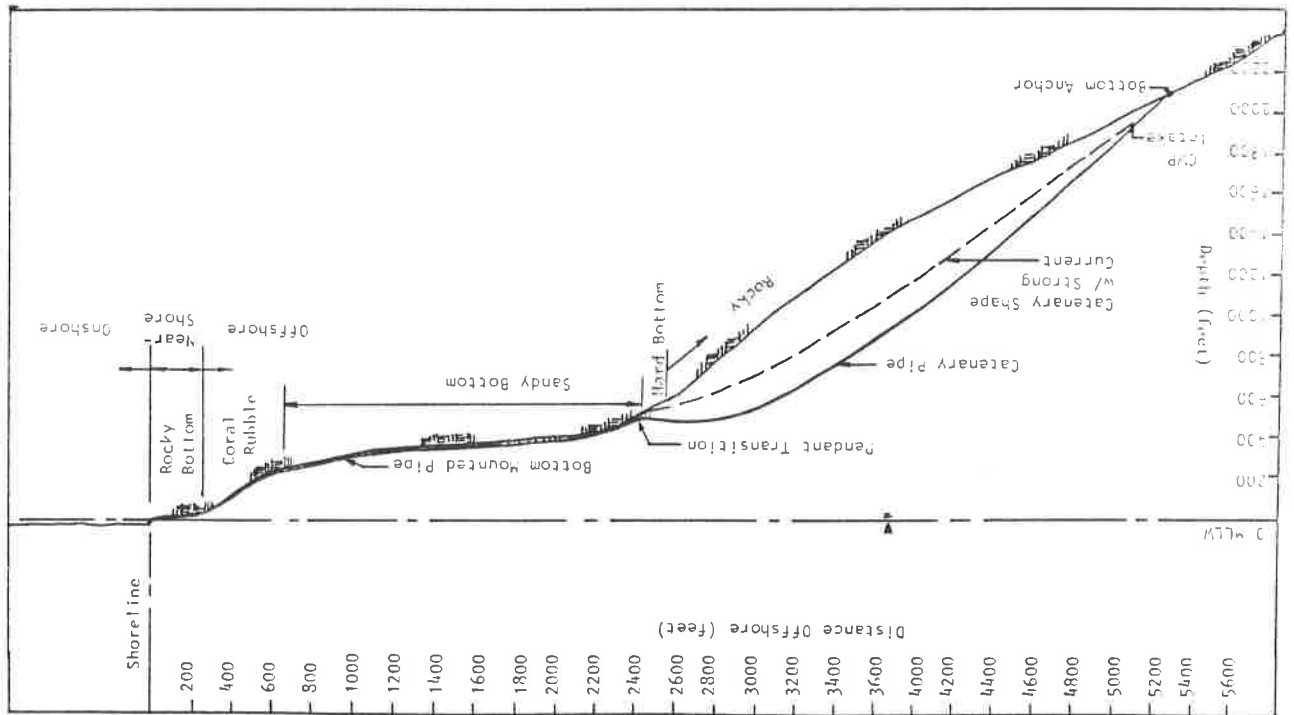

Fig. 3-2. OFFSHORE ELEVATION VIEW OF THE 12-INCH COLD WATER PIPE AT NELH, KEAHOLE POINT, HAWAII

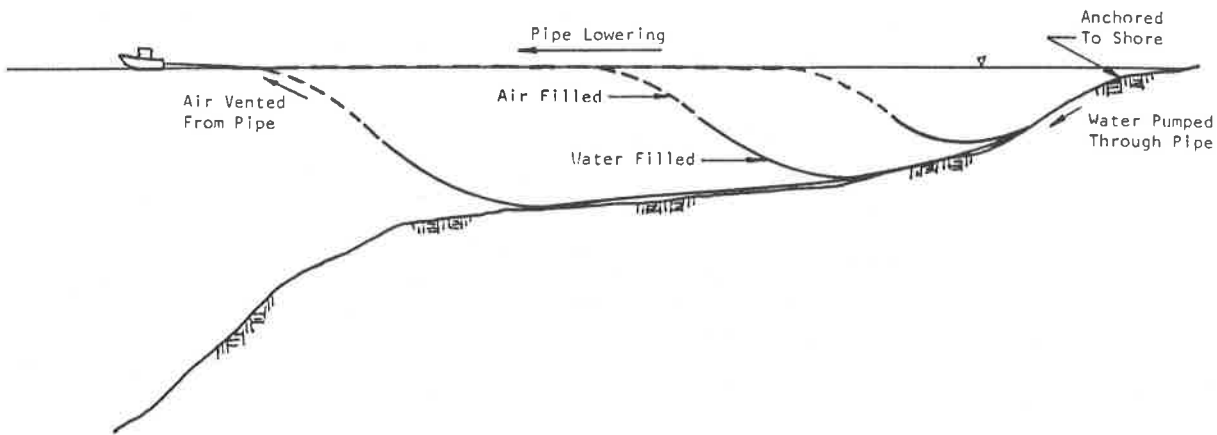

Fig. 3-3. SCHEMATIC DIAGRAM SHOWING THE PIPE-LOWERING OPERATION FOR DEPLOYMENT OF A BOTTOM-MOUNTED PIPELINE

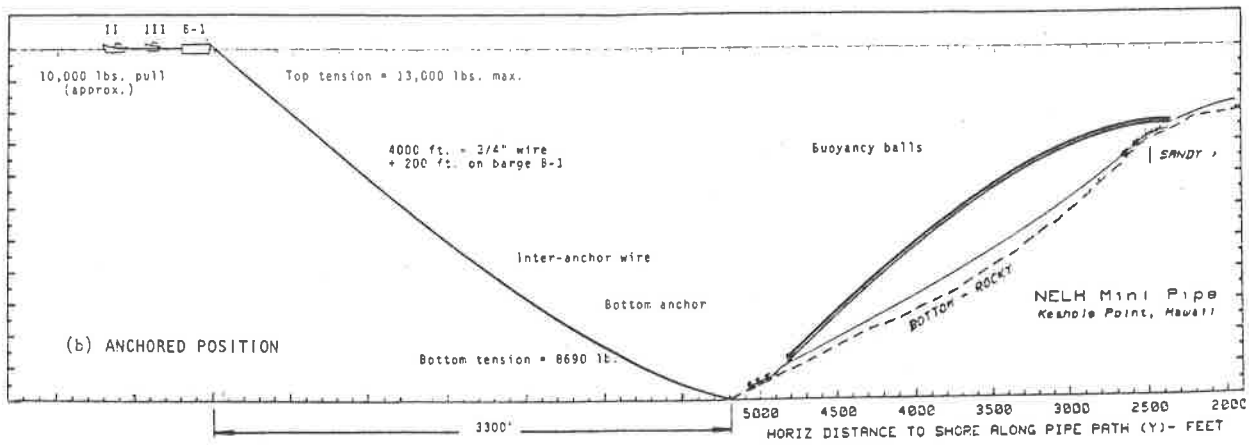
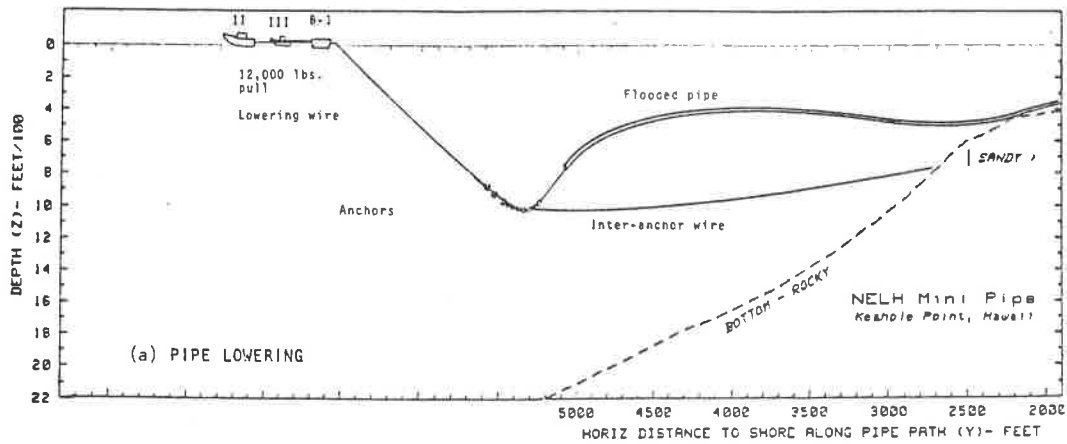

Fig. 3-4. DEPLOYMENT OF OFFSHORE CATENARY SEGMENT OF PIPELINE (From Makai Ocean Engineering Inc., for 12" Pipeline at NELH)

and the next segment is rolled behind it and connected. The combined length is then pulled out and the inlining process repeated until the entire pipeline length is connected. Figure 3-5 shows a sketch of this deployment operation. The pipeline is usually dragged on the bottom since waves and currents can more easily push the pipeline off course if it is buoyant. However, this requires that any dragging obstructions be removed along the pipeline route, and that the pipeline material be resistant to abrasion or protected in some manner. For floating pipeline strings, it is necessary to be able to quickly flood the line if environmental conditions become too severe during the deployment operations. A version of this method is planned for the deployment of a 15 inch polyvinylchloride (PVC) pipeline by Hawaiian Abalone Farms at MELH. The outcome of this deployment operation, presently scheduled for this summer, will provide valuable insight and experience for future GWF design and construction at Keahole Point and vicinity.

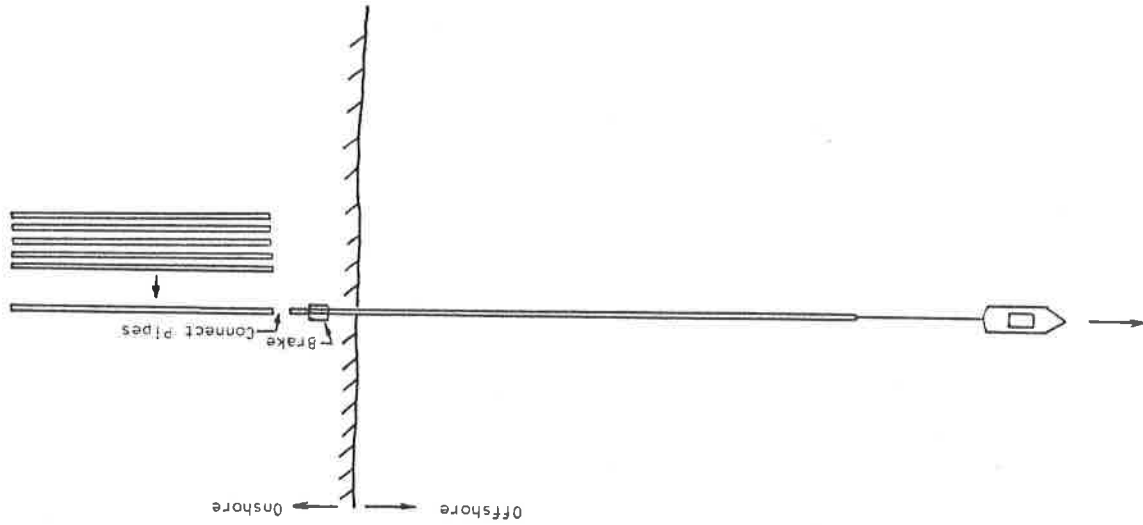

Fig. 3-5. SCHEMATIC PLAN VIEW OF THE PIPE-PULLING OPERATION FOR DEPLOYMENT OF THE PIPELINE ON-SITE

4. DESCRIPTION OF THE PROPOSED ONSHORE PIPELINES AND PUMP STATIONS FOR THE HOIST PARK AND THE U.S. DOE OTEC PROJECT:

a. General

The anticipated ocean water flow requirements for the HOIST Park and the planned U.S. Department of Energy's OTEC project at NELH dictate the need for pipeline sizes in the range of 30 - 48 inch nominal diameter. The ocean water requirements for the HOIST Park are presently estimated to be about 20,000 gpm of cold water and 80,000 gpm of warm water, based on the initial marketing and feasibility study. Clearly, the actual demands will be dependent on the marketing, planning, and detail design studies may modify the ocean water flow requirements, for this EIS evaluation the conceptual design of the pipes and pumping system for the above mentioned flow rates will be described. Pipe sizes of 48 inch nominal diameter are envisioned for the HOIST Park warm and cold water requirements. The U.S. DOE's project needs are 6,500 gpm of cold water and 9,500 gpm of warm water. While the final design of this ocean water supply system is not yet known, the pipe sizes are estimated to be about 30 inch nominal diameter.

The location at the shore for the pump stations and the overland routing of the pipes will depend on tradeoffs between many factors. Considerations include the following:

- (1) The CWP terminus at the coast would preferably be located at or close to Keahole Point to minimize the offshore CWP length, since the CWP carries the largest risk and cost of any component of the ocean water supply system.
- (2) The terminus of offshore pipelines at the coast would preferably be located close to the users to minimize overland piping and pumping costs.
- (3) The offshore pipelines (WMP and CWP) would preferably have the same terminus at the coast to minimize pump station construction costs.
- (4) The pump stations would be located at the onshore terminus of the offshore pipelines and as close to the shoreline as practicable to minimize excavation costs.

b. Conceptual HOIST Park Onshore Ocean Water Supply Facilities

The design of the ocean water supply system for the HOIST Park requires the evaluation of potential phasing requirements as well as cost tradeoffs between alternative pipeline routes. Depending on the Master Plan and design

studies, the ocean water flows may be phased according to the estimated tenant requirements. While it may be more economical in the long run to initially provide a system capable of delivering maximum design demands, the funding limitations may preclude this, resorting instead to phased multiple smaller systems to satisfy demands as needed. For this EIS evaluation, an ocean water supply system capable of delivering maximum estimated ocean water requirements will be described, since any smaller system will have lesser environmental impacts.

Preliminary cost evaluations between a CWP route off Keahole Point and a CWP route directly fronting the HOIST Park indicated that the order of magnitude overall system costs for both routes were approximately the same. The estimated offshore CWP length from Keahole Point is approximately 2,000 feet shorter than for a route directly offshore the HOIST Park. However, the additional 7,000 feet of overland pipe from Keahole Point to the HOIST Park offsets the savings in the offshore pipe length. Since detailed bathymetry is not yet available offshore the HOIST Park, estimated offshore CWP costs are very conceptual. It is possible that detailed offshore surveys may identify a favorable route to suitably cold water depths south of Keahole Point resulting in lowest overall construction costs. Depending on the selected CWP route, the WMP may not have the same terminus at the coast. For instance, if the CWP route off Keahole Point is selected, then it may be more cost effective to provide a separate warm water pump station closer to the HOIST Park due to savings in overland piping and pumping costs. Figure 4-1 schematically describes the potential pump station locations and pipeline routes for the extreme northern and southern potential CWP routes. In all likelihood, the first phase CWP will be located at Keahole Point due to time and funding constraints. The area offshore NELH has been the focal point of many past surveys and thus no additional field information would be required related to definition of the existing oceanic environment and particularly ocean bottom geology and bathymetric conditions. On the other hand, no surveys have been performed for the CWP route immediately offshore the HOIST Park, and thus extensive offshore field investigations would be necessary before design can proceed.

The pump stations will probably be constructed onshore with a deep, free surface sump, whereby the water is pumped from the sump rather than the pump being directly connected to the offshore suction pipe. An onshore station will provide for more convenient maintenance of the pumps, which is a necessary part of any commercial operation in order to maintain the continuous flow capability. Depending on the existing ground elevation, the pump stations could be constructed almost entirely below grade. This would minimize potential storm wave damage to the structure, since the pump station would be located close to the shoreline to minimize excavation costs. Figure 4-2 schematically depicts a

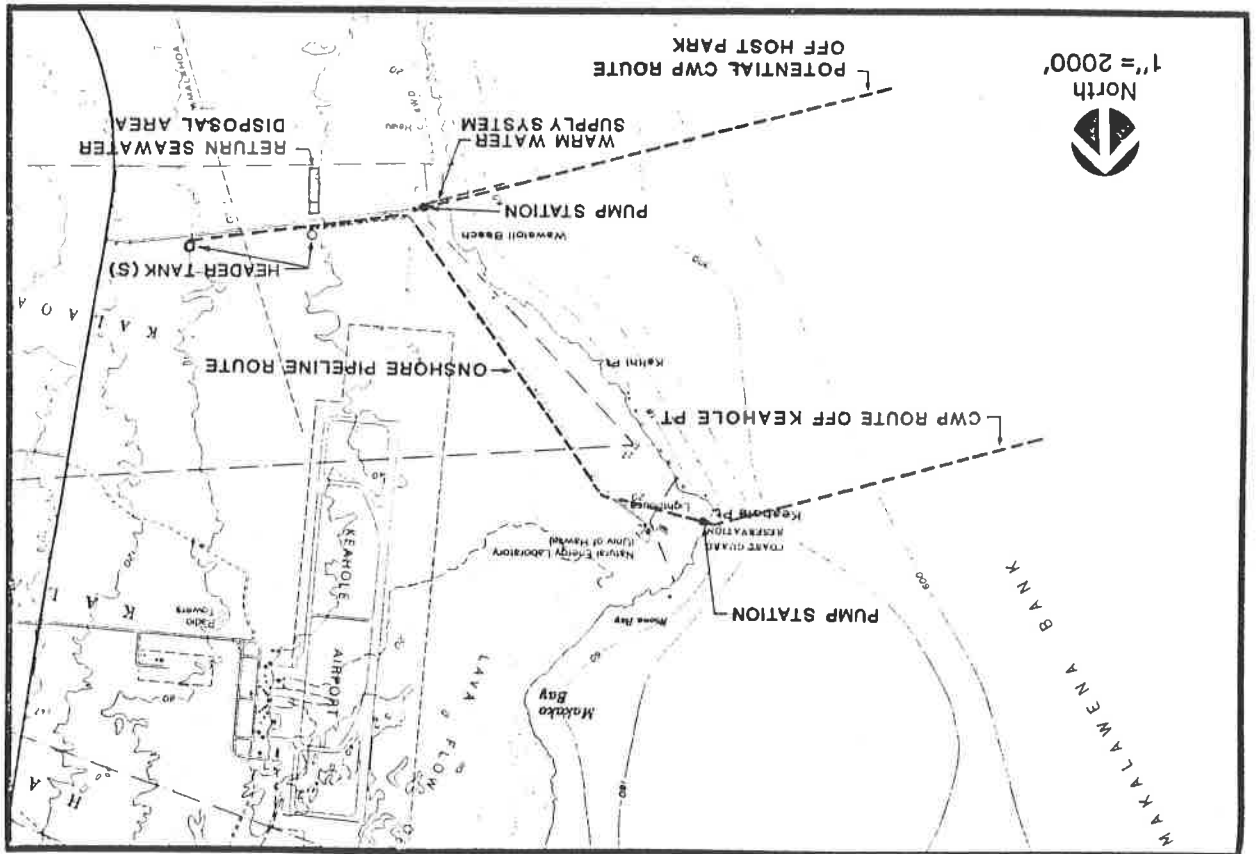

Fig. 4-1. LOCATION MAP FOR POTENTIAL COLD WATER AND WARM WATER SUPPLY SYSTEM ROUTES FOR THE HAWAII OCEAN SCIENCE & TECHNOLOGY PARK, KEAHOLE, HAWAII

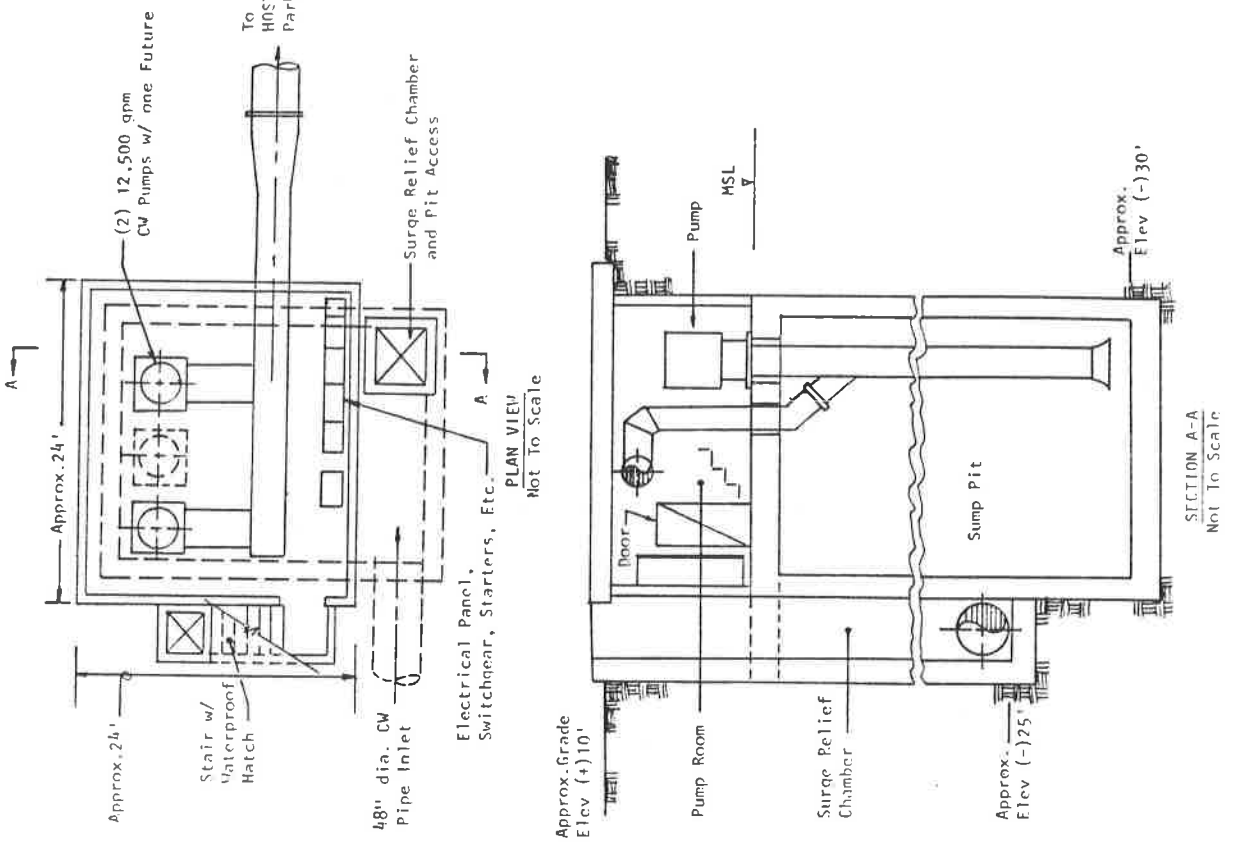

Fig. 4-2. CONCEPTUAL COLD WATER PUMP STATION FOR THE HOST PARK

conceptual pump station capable of providing 20,000 gpm of cold water. A separate warm water pump station would be similar in design, however, the depth of the sump below sea level could be reduced since the suction pressure requirements are not as extreme as for the cold water system. Any portion of the facility above grade would be designed to withstand estimated storm wave runup, overtopping, or impact loads. For this same reason, the onshore pipelines from the pump station would either be buried or protected through the shoreline area for at least a few hundred feet inland. Hence, the pump station(s) and pipelines near the shoreline will have minimal visual impacts and should not hinder shoreline access. However, it is expected that short-term construction activities will preclude shoreline access in these areas. Therefore, phasing of multiple smaller systems would have relatively greater impacts to shoreline recreation than the provision of one large system, since disruption will occur more often with each incremental addition to the system even though the magnitude of construction activities for individual increments are smaller.

The inland portion of the pipelines are expected to be exposed to minimize construction costs. Pipeline routing between NELH and the HNST Park will follow the coastal roadway on the maua side. Pipeline routing inland to the HNST Park will follow alongside the major roadway up to the header tank(s). Since the HNST Park system will serve multiple users, the conceptual design envisions the use of header tanks to isolate the demand flow from the pumping supply. Figure 4-3 shows a typical section view of the pipeline location alongside the roadway. The rugged lava terrain will be graded in order to lay the pipes on the ground. For security and safety reasons, either fencing or a berm will be constructed between the pipelines and the roadway.

C. Conceptual DOE, OTEC, Onshore, Ocean Water Supply Facilities

The design of the ocean water supply system for the U.S. DOE OTEC project would probably require fewer tradeoff evaluations, since the project will be located at NELH and close to the preferred CWP route off Kihalele Point. Figure 4-4 schematically describes the potential pump station location and pipeline route for the OTEC ocean water supply system at NELH. The CWP and WWP would have the same terminus at the coast to minimize pump station construction costs. Figure 4-5 schematically depicts a conceptual pump station which accommodates both the CWP and WWP, as well as the mixed water discharge pipe. The construction of this system will not be phased.

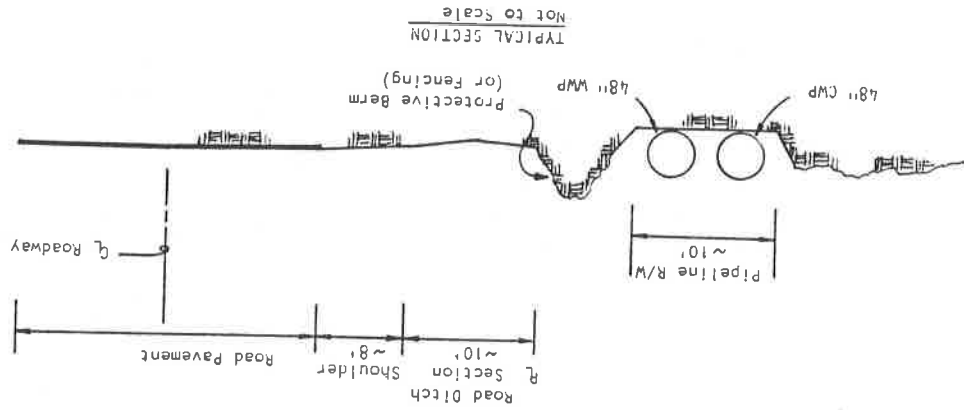
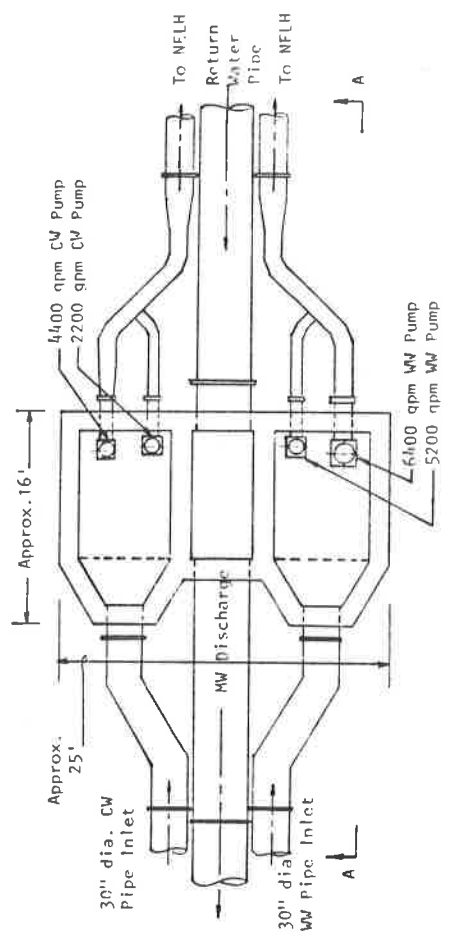
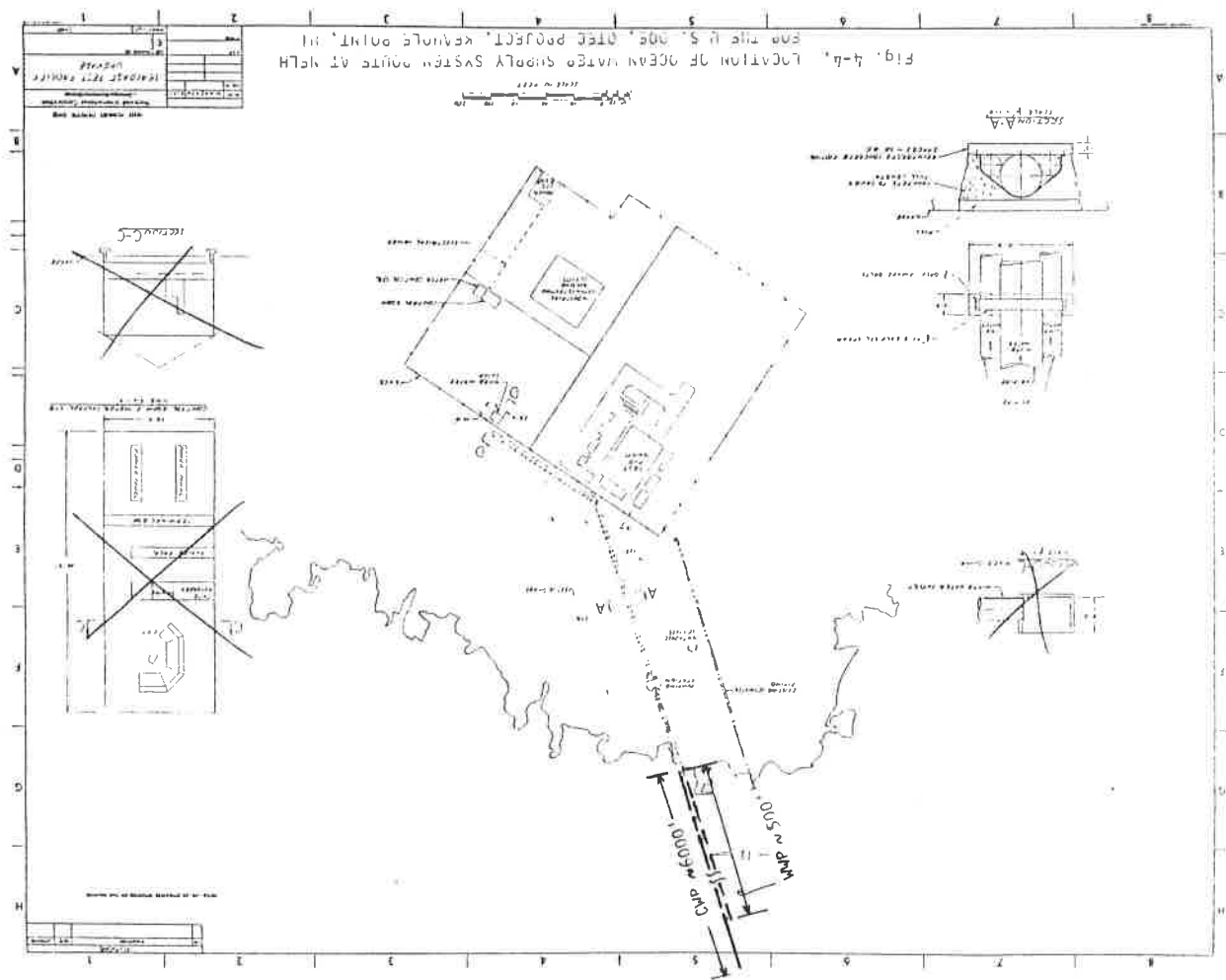
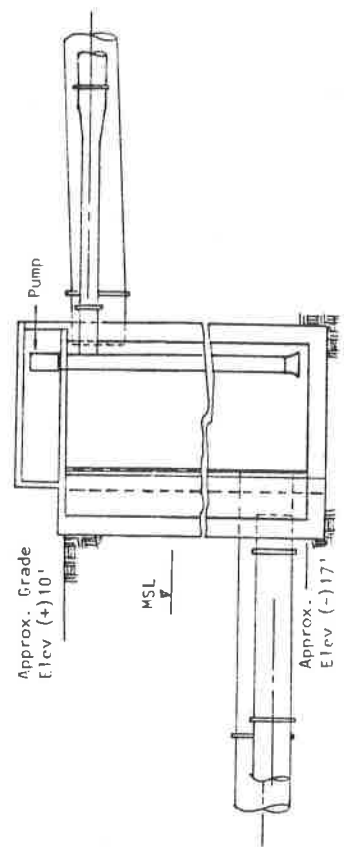

Fig. 4-3. TYPICAL PIPELINE LOCATION ALONGSIDE ROADWAY



PLAN VIEW
Not To Scale



SECTION A-A
Not To Scale

Fig. 4-5. CONCEPTUAL PUMP STATION FOR THE U.S. DEPARTMENT OF ENERGY, OTEC OCEAN WATER SUPPLY SYSTEM

5. SECURITY NEEDS FOR THE OCEAN WATER SUPPLY SYSTEMS:

Main components of an ocean water supply system include the offshore pipeline, the onshore (or offshore) pump station, and the onshore pipeline. For the HOST Park system(s), which will serve multiple users, the conceptual design includes header tank(s) to isolate the demand flow from the pumping supply. The primary pipeline from shore terminates at the header tank, from which distribution is made to the individual users.

Security of the offshore pipelines is not anticipated to be of concern. The pipelines will either be buried or armored through the nearshore zone (shallow water region) to protect the pipes from design wave forces. Since there are no designated anchorages or known mooring areas along this portion of coastline, there is little danger of potential damage to the exposed offshore portion of the pipelines from large vessel anchors. Small fishing boats do not generally anchor offshore, nevertheless, their small anchors have little potential for damaging the pipelines. Therefore, no specific security measures are required for the offshore pipelines or possible offshore pump station.

The conceptual onshore pump station designed with free-surface deep sump would be located as close to the shoreline as practicable to minimize excavation costs. The pump station would be constructed almost completely below grade to minimize potential storm wave damage to the structure. Any portion of the facility above grade would be designed to withstand estimated storm wave runup, overtopping, or impact loads. For this same reason, the onshore pipelines would either be buried or protected through the shoreline area for at least a few hundred feet inland. Therefore, no specific security measures are deemed necessary for the shoreline portion of the pipelines or the pump station(s).

The inland portion of the pipelines are expected to be exposed to minimize construction costs. Pipeline routing between NELH and the HOST Park will follow the coastal roadway on the mauka side. Pipeline routing inland to the HOST Park will follow alongside the major roadway up to the header tank(s). Security and safety concerns for the exposed pipe include possible vandalism and vehicle damage. Chain link fencing alongside the roadway is an effective measure. However, it is both costly and visually obtrusive, although plantings would minimize the visual impact. A less effective alternative, but one that is more aesthetically pleasing, is the provision of a berm between the roadway and pipeline. Since grading of the rugged lava terrain will be required to lay the pipes, the pipeline right-of-way could be cut slightly below grade and the excess material used to build a protective berm. This 3-4 foot high berm would provide a visual as well as physical barrier between the roadway and pipeline. Since the berm would be constructed of native

basaltic material, it would blend in with the surrounding environment. However, this alternative would require a wider pipeline right-of-way to accommodate the berm.

6. DESCRIPTION OF EXISTING PIPELINE SYSTEMS AT NELH:

There are presently three 12 inch diameter ocean water intake pipes offshore Keahole Point serving NELH. These include two warm water intake pipes and one cold water pipe. All intake pipes have the same terminus at the shoreline near the Keahole Point Lighthouse. One WWP intake is located at the base of the shoreline cliff in about 15 ft water depth, while the second WWP extends approximately 300 feet offshore to 80 foot water depth. This second WWP is the primary intake and draws warm water from approximately 30 feet below the water surface. The CMP extends approximately 5,500 feet offshore to water depth of approximately 2,000 feet. (Refer to Figures 3-1 and 3-2 for details of the cold water pipe).

All pipelines are exposed above the seafloor: the very nearshore sections of the pipelines are bolted to the rocky ocean bottom while the deeper CMP section, to water depth of approximately 500 feet, is anchored to the sandy bottom with concrete blocks. Beyond the 500 foot depth, the CMP is buoyed above the steep ocean bottom in a catenary, with only the extreme offshore end of the pipe anchored to the bottom. All pipelines are made of high density polyethylene (HDP) material. The pumps for the CMP are located offshore in water depth of about 25 feet. Two Pioneer down hole, inline type pumps deliver approximately 1,000 gpm of cold water. The pumps for the WWP's are located onshore at NELH.

In addition to the ocean water supply systems, a 75 foot long CMP test pipe section is situated offshore Keahole Point. This 8-foot diameter pipe section is located north of the intake pipelines on the rocky nearshore slope between water depths of about 75 and 125 feet. Figure 6-1 shows photographs of this test pipe prior to deployment at Keahole Harbor and in its deployed configuration offshore Keahole Point. The pipe section was part of the OTEC "At-Sea Test Program" sponsored by the DOE, for the purpose of demonstrating the installation of a large diameter CMP on a steep slope and to measure the wave and current forces on such a large diameter pipe. The experiment has recently been terminated after a one-year data acquisition program, and the test pipe will be removed sometime in the near future.

A 48 inch HDP cold water pipe was to have been installed at NELH to replace the existing 12 inch interim pipeline. The attempted deployment of this pipeline in September-October 1983 was not successful, as a major portion of the pipe was lost at sea during the transit from Kawaihae Harbor to Keahole Point. While this experience exemplifies the risks associated with offshore pipeline construction, the causes attributing to the deployment failure have been analyzed and does not preclude the potential for successful deployment of future pipelines. Figure 6-2 shows the 48 inch CMP at Kawaihae Harbor. This is the same pipe design presently anticipated for the future HDSI Park CMP.

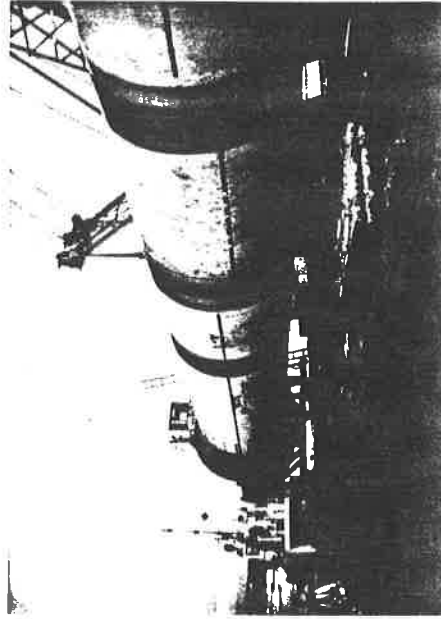

(a) Test Section at Kawaihae Harbor Prior To Deployment



(b) Test Section Mounted on Seafloor Offshore Keahole Point (Note steep bottom slope)

Fig. 6-1. VIEWS OF THE 8-FOOT DIAMETER CMP TEST SECTION FROM THE OTEC AT-SEA TEST PROGRAM, SHELF-MOUNTED EXPERIMENT (SPONSORED BY THE U.S. DEPARTMENT OF ENERGY)

7. DESCRIPTION OF PROPOSED OFFSHORE PIPELINES AND POTENTIAL ENVIRONMENTAL IMPACTS:

a. General

The potential offshore pipeline routes for the HOST Park and the planned U.S. DOE OTEC project at NELH are schematically shown on Figures 4-1 and 4-4, respectively. Final route selection for the HOST Park pipelines will depend on detailed planning and design studies involving the evaluation of cost tradeoffs between alternative routes, as discussed in Section 4, as well as other factors. The offshore pipeline route for the DOE OTEC pipelines will most probably be as indicated in Figure 4-4, since the project is located at NELH and close to the preferred CMP route offshore Keahole Point. For this EIS evaluation, potential impacts associated with pipeline routes off Keahole Point as well as offshore the HOST Park will be described.

Figure 7-1 shows a schematic profile view of the pipeline through the nearshore zone to the onshore pump station. The most significant impacts are anticipated to be associated with the short-term construction activities in the nearshore zone. Due to the large flow requirements and maintenance considerations, the pump stations would probably be constructed onshore. The conceptual design of the pump stations includes a deep, free surface sump (refer to Figures 4-2 and 4-5). The suction pressure for the offshore pipe is developed by the elevation difference between sea level and the free surface of the sump. Thus, the offshore pipe would discharge into the sump at some design elevation below sea level. This requires trenching for the offshore pipeline through the shoreline and nearshore areas. The amount of excavation and trenching required for the pump station and offshore pipes depends on the shoreline elevations and the offshore bathymetry in relation to the sump design requirements. While an offshore submerged pump station would require little or no excavation, the engineering and maintenance problems associated with such a design presently indicates that an onshore pump station is more feasible.

b. Potential Nearshore Impacts for a Pipeline Route Offshore Keahole Point

The rocky basalt shoreline at Keahole Point drops rather abruptly to water depths of about 15-20 feet, whereupon the ocean bottom slopes gradually to a shelf break at about 40-50 foot depths. The estimated required elevation of the cold water suction pipe at the pump station is approximately 25 feet below sea level for the HOST Park CMP. The distance from shore to comparable water depth is approximately 100 feet offshore Keahole Point, and the estimated offshore excavation quantity for the cold water pipe trench is 90 cy for the 48 inch HOST Park CMP. The estimated required elevation of the warm and cold water pipes at the pump



Fig. 6-2. VIEW OF THE 48-INCH CMP AT KAWAIIHAE HARBOR, DURING ATTEMPTED DEPLOYMENT OPERATIONS IN SEPTEMBER-OCTOBER 1993

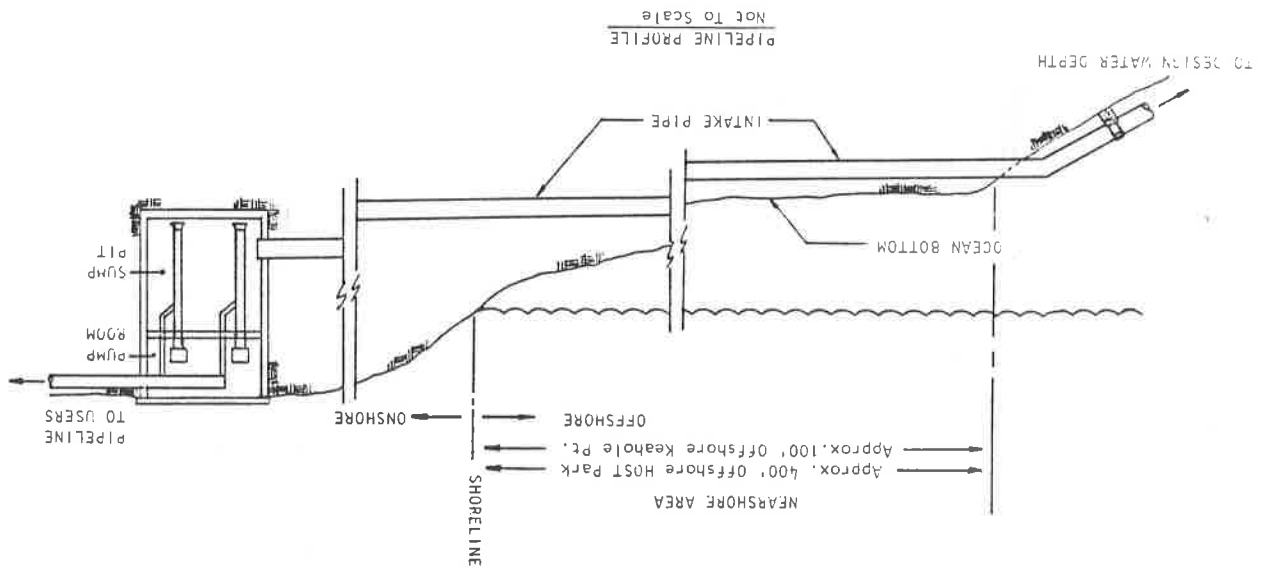

Fig. 7-1. SCHEMATIC VIEW OF NEARSHORE PIPELINE PROFILE AND PUMP STATION

station for the DOE OTEC intake is approximately 17 feet below sea level. The mixed water return pipe will also discharge at the same elevation from the pump station. Since comparable water depth is found at the base of the shoreline cliff, little or no offshore trenching will be required for these OTEC pipelines.

The onshore elevations at the pump stations are approximately 8-10 feet above sea level, a distance of about 150 feet inland. The estimated onshore trenching from the shoreline to the pump station for the DOE cold, warm, and mixed water pipes requires a total of approximately 1560 cy of excavation. The estimated onshore excavation quantity for the DOE pump station is 490 cy. The estimated onshore trenching and excavation quantities for the HOST Park CWP and pump station are 800 cy and 1170 cy, respectively.

The shoreline and nearshore foundation material is primarily basalt. Sand tossed ashore by storm waves forms a fringing veneer cover along the shoreline. The nearshore bottom is virtually bare of sand or coral growths at less than 25 foot depths within the areas to be trenched for the offshore pipes. Drilling and blasting is anticipated to be required for excavation due to the hardness of the basalt material. However, unlike coral limestone, the dense basalts would generate relatively little silt during the dredging operation. The construction excavation and dredging activities would be similar to the Honokohau Harbor construction, except on a much smaller scale. Honokohau Harbor was dredged inland and connected to the ocean by a short entrance channel. Post construction reconnaissance investigations (Blenfang, 1975) prior to expansion of the mauka basin indicated no significant adverse impacts to the marine environment as a result of the dredging operations. Sediment sampling within the harbor showed varying sediment depth ranges from 1/2 to 10 inches for the most part (figure 7-2). The sediments were black pumice and appeared to be residues of ground lava rock as a result of the blasting and dredging activities which created the harbor. The sediment was composed primarily of grain sizes ranging from fine sands to silt (grain size diameter less than 0.125 mm). The total estimated volume of sediment (saturated) is approximately 2.3% of the total volume of material dredged for the harbor basins.

Assuming that the sediment volumes represent the total quantity of fines generated by the dredging for the basins, then it is expected that the offshore dredging for the pipelines at Keahole Point would generate similar relative quantities of silts. Thus, only about 2 cy of silts would be generated by the offshore dredging for the potential HOST Park CWP. Due to the relatively strong nearshore currents offshore Keahole Point, the silt size particles would be quickly dispersed away from the area. For example, assuming a 70 foot fall distance and silt particle size diameter of

0.02 mm with a .00007 ft/sec fall velocity, the horizontal excursion distance would be approximately 70 miles with a 1/2 knot (0.84 ft/sec) alongshore current. Fine sand size particles (0.1 mm diameter) with a 0.0016 ft/sec fall velocity would have a horizontal excursion distance of approximately 3 miles. Hence, the concentration of suspended particles in the water column during dredging would be very small.

c. Potential Nearshore Impacts for a Pipeline Route Offshore the HOST Park

The rocky basalt shoreline fronting the HOST Park slopes more gently offshore than at Keahole Point. The estimated distance from shore to water depth of 25 feet is approximately 400 feet. Hence, considerably more offshore dredging would be required for the cold water pipe trench, as well as the warm water pipe trench, compared to pipeline routes at Keahole Point. Estimated offshore excavation quantities are 890 cy and 400 cy for the HOST Park CMP and WMP, respectively.

The onshore elevations at the pump station are approximately 8-10 feet above sea level, comparable to the Keahole Point shoreline. Hence, the onshore trenching and excavation quantities for the HOST Park CMP and pump station are comparable to the quantities at Keahole Point, approximately 1900 cy total. If a pump station is provided to accommodate both the CMP and WMP, the onshore excavation requirements will be almost doubled.

The shoreline and nearshore foundation material is primarily basalt. However, there is considerable more sand along the shoreline areas than at Keahole Point. Blasting will be expected for the offshore dredging through the relatively wide nearshore area. Based on 2-3% of the total estimated offshore dredging quantities for the 48 inch cold and warm water pipes, the total volume of silts expected to be generated over the duration of the blasting and excavation activities is 30 cy. Relatively strong nearshore currents are expected to quickly flush the silts away from the dredging area, and the thickness of fine sediment cover within the general vicinity of the dredging would be negligible. For example, assuming that there were virtually no currents and all of the silts settle within a 500 x 500 square foot area, the average sediment thickness would be only 1 mm.

d. Potential Offshore Impacts of Pipelines

Seaward of the trenched areas, the pipelines will be exposed above the seafloor. The pipes would be secured to the ocean bottom and possibly armored to sufficient offshore depths beyond the influence of large storm waves. Deployment of the deepwater CMP segment is anticipated to be similar to

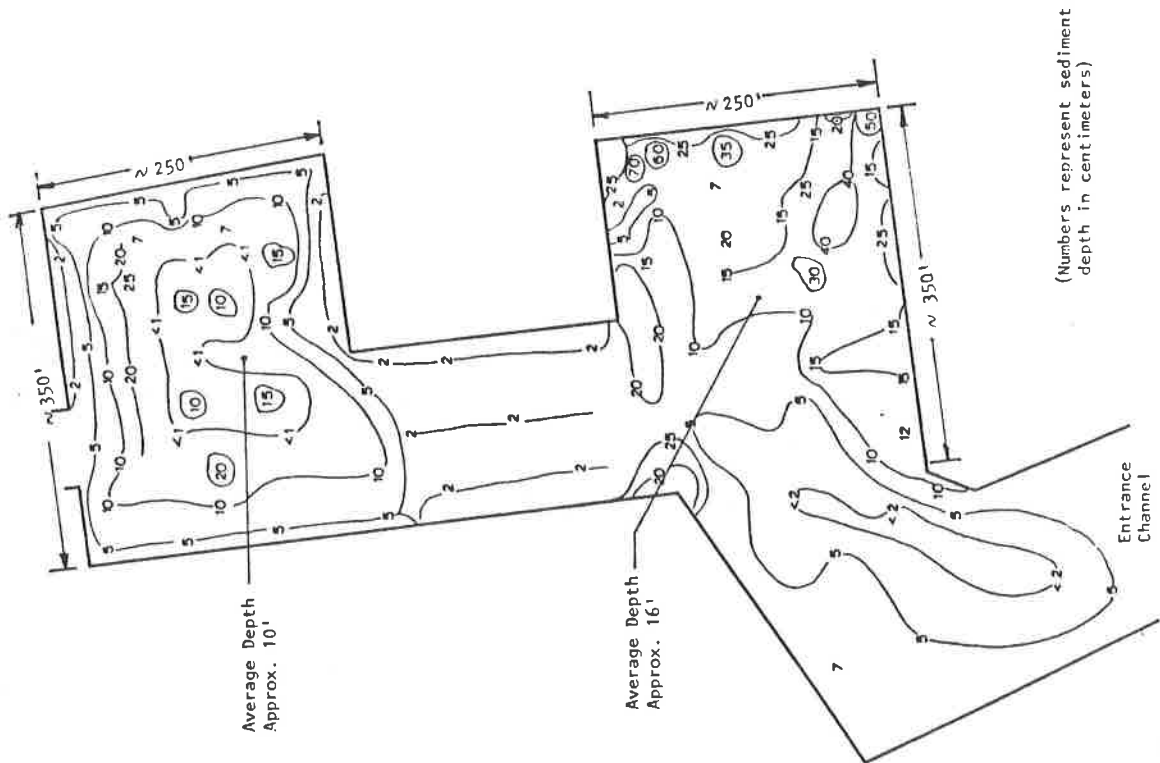

Fig. 7-2. SEDIMENT THICKNESS CONTOURS WITHIN HONOKOHAU HARBOR, HI (from Rienfann, 1975)

the previous deployment of the existing 12 inch CMP at NELH, and construction impacts would be negligible.

e. Potential Impacts on Littoral Processes

There is virtually no littoral transport along this portion of coastline. The nearshore areas are rocky and nearly devoid of sand. Whatever sand exists along the shoreline is the result of storm waves overtopping the shore and depositing the sand along the backshore areas. Hence, any pipelines traversing the nearshore areas would have no impact on existing littoral processes.

REFERENCES:

- Bienfang, P. (1975), "The Oceanography of Honokohau Harbor, Hawaii", Appendix B of the Environmental Impact Statement for Development of Honokohau Boat Harbor, prepared for Harbors Division, State of Hawaii Department of Transportation, prepared by Oceanic Institute.
- High Technology Development Corporation (1985), "Hawaii Ocean Science & Technology Park, Marketing and Feasibility Studies", prepared by Helber, Hastert, Van Horn & Kimura, Planners, Arthur Young and Company, Sam O. Hirota, Inc., Edward K. Noda & Assoc., and KFC Airport, Inc.
- Koh, R.C.Y.; Nakazaki, E.; Divoky, D.; Noda, E.K.; Ishii, B. (1984), "Effluent Plume Dispersion and Biological Implications of HOTEK", Report No. EKN-1023-R-1-1, prepared for TRW, Energy Technology Division, Redondo Beach, prepared by E.K. Noda & Associates, Honolulu.
- Sea Engineering, Inc. (1985), "Kealahou Ocean Outfall, Ocean Data Collection Program", prepared for R.M. Towill Corp., Honolulu, in support of the proposed Kailua-Kona Sewerage System, Phase IV.

APPENDIX C

TECHNICAL EVALUATION OF SEAWATER RETURN FLOW AND
WASTEWATER DISPOSAL SYSTEMS AT NELH/HOST PARK

DAMES & MOORE
JUNE 1985

DRAFT EIS
HYDROLOGICAL SECTION
HIGH TECHNOLOGY DEVELOPMENT CORPORATION

Dames & Moore Job No. 14408-001-11
July 12, 1985

GENERAL HYDROLOGY

The climate of the Keahole region is arid in the coastal area but changes gradually to humid in the Hualalai undissected upper slope. The area receives little tradewind rainfall; instead, much of the moisture is accounted for by orographic showers that form within sea breezes which move onshore and upslope. The mean annual rainfall ranges from less than 20 inches along the coast to as much as 75 inches on the lee of Hualalai crater.

Pan evaporation is typically high, in the general range of 0.18 inches per day for the winter and 0.36 inches per day for the summer as measured at Anaeohoomalu (Kay et al. 1977). There is no pan evaporation measurement for the Keahole region. Neither perennial nor intermittent streams normally reach the ocean. The sources of groundwater recharge come primarily from the small residual of rainfall after abstraction by evapotranspiration in the upland area and to a lesser extent from the infrequent cyclonic-storm rain affecting the entire area. All groundwater discharges are natural as there is no groundwater development of any kind. These discharges are primarily diffused and not usually visible along the shoreline; only one shoreline spring near Wawaloli Beach, noticeable during low tide, has been observed.

GEOLOGY

The Hawaii Ocean Science and Technology (HOST) Park and the Natural Energy Laboratory of Hawaii (NELH) near the Keahole Point region consists of primitive basalts of the Hualalai volcanic series, the principal effusive rock

of Hualalai volcano (Stearns and MacDonald 1946). The series are composed of heterogeneous, poorly-layered, laterally and vertically restricted units of aa, clinker, and pahoehoe consisting predominantly of basalts and olivine basalts. Individual units extend laterally no more than several hundred feet and vertically less than 100 feet. The average lava flow thickness is about 10 feet. A late trachyte effusion from Puu Waawaa occurs about 15 miles northeast of Keahole.

The lavas for several miles around Keahole Point congealed as flank flows having regional dips of less than 5 degrees; no surficial evidence exists of intrusive rocks, neither dikes nor sills. The Hualalai volcano, although one of the oldest on the Island of Hawaii, erupted as recently as 1800 to 1801 when the Kaupulehu lava flow reached to within 2,000 feet of Keahole Point. This flow still retains its original appearance because, in the semiarid climate of the coastal sector of western Hawaii, weathering is an extremely slow process. The 1800 to 1801 and previous visible flows have broken, rough surfaces transected by irregular vertical fractures. Lava tubes and other large openings, many of them collapsed, are common.

Except for volumetrically insignificant, spotty accumulations of marine sediments near the coast, all of the exposed rocks are the original, in place basaltic lavas. The depth of weathering is slight, even on the oldest strata, and soil formation is incipient at best. The marine sediments, less than a few feet thick in the most favorable locations, consist of sporadic occurrences of calcareous sand, cemented beach rock, and coral and basaltic gravels driven on shore by stormy seas. These sediments are restricted to a narrow zone along the coast below an elevation of about 10 feet above sea level.

No unusual structural features exist in the region. The nearest rift zone is at least five miles to the north. There is no evidence of faulting or

other regional deformation. Indeed, for many miles around Keahole, the geology is that of low dipping flank flows of primitive basalt, a favorable condition for highly permeable aquifers.

GROUNDWATER OCCURRENCE AND AQUIFER CHARACTERISTICS

A thin Ghyben-Herzberg lens underlies the coastal region of western Hawaii from Keahole northward to beyond Kawaihae and southward to beyond Keauhou. In the Keahole vicinity, the lens is brackish, probably less than 125 feet thick and discharges freely along the coast in a narrow band a few feet wide in the intertidal zone. The basal lens water does not meet the U.S. Drinking Water Standards even at the top of the lens and at a distance about 3 miles from the shoreline. Chloride, for example, measured to be about 5,000 milligrams per liter (mg/l) to 520 mg/l, and total dissolved solids (TDS) to be about 10,000 to 1,200 mg/l over this distance.

In some places, the lens is visible where the basaltic surface has collapsed and near the shore where marine sediments have filled depressions in the original surface. Maciolek and Brock (1974) describe exposures of the lens (anchialine ponds) along the Kona coast. Small ponds exist several hundred yards north and south of Keahole and near Wawaloli Beach, which fronts the HOST Park one mile to the south. However, the nearest ponds of exceptional value are the Kahanaiki Ponds located near Wawahiwaia Point, 2.25 miles south of Keahole and about 1 mile southwest of the southern limit of the Park. Only ponds mauka of the road near Wawaloli Beach were present during this study. Those near the beach were possibly filled in with sand during storms over the last 5 years. The ponds are very small, with a surface area of less than 100 square feet.

The quality of the surge channel water near Wawaloli Beach is influenced by the basal lens discharge to the extent that the coastal water quality standards are exceeded in terms of nitrogen and phosphorus (WRRC, 1980). The principal sources of the nutrients in the basal lens are, however, believed natural rather than man-made. Likewise, the deep ocean water also exceeds the same nutrient standards.

Previous investigations by the Water Resources Research Center of the University of Hawaii (Adams et al. 1969) found no unusual groundwater conditions in the Keahole region. The infrared scan of the coastline did not show any evidence of substantial freshwater outflow. The resistivity traverse indicated evidence of only brackish water at elevations below the 300-foot topographic contour, lying about 2 miles inland, and interpretation of the audio-magnetotelluric survey suggested the presence of only a very thin layer of fresh water.

Observations made by the Water Resources Research Center of the University of Hawaii (1980) in conjunction with the geophysical results of previous studies show that an unconfined Ghyben-Herzberg lens containing brackish water underlies the area to at least 5 miles north of Keahole, at least 3 miles to the east, and more than 5 miles to the south. Evidently no structural or lithologic barriers interfere with hydraulic continuity throughout this region. The hydraulics of groundwater flow can therefore be described in terms of a highly permeable basaltic aquifer carrying a continuous thin basal lens of brackish water underlain by salt water.

The brackish water of the lens flows toward the coast along a regional gradient of about 1 foot per mile. The head in well 4360-1 (Kalaoa), 3 miles inland of Wawaloli Beach, was 3.2 feet when drilled, implying an average gradient of 1.1 feet per mile. Kanehiro and Peterson (1977) gave an average

gradient of 1 to 2 feet per mile south of Keahole for the reach between Kiholo and Puako. The brackish water discharges preferentially at indentations in the coast, such as Wawaloli Beach. Groundwater flow lines converge toward these indentations while diverging at head lands. The largest visible discharge of the lens in the Keahole area is near Wawaloli Beach, which lies along the coastal boundary of the park.

The salt water below the lens in the near-shore area is alternatively driven inland and seaward by tidal action so that its dynamics cannot be expressed in terms of a unidirectional, uniform flow field. In hydraulic analysis, however, the salt water is usually treated as being static. This assumption avoids insuperable obstacles to both analytical and numerical solutions of the flow equations. The extrusive basalts of the Hualalai volcanic series are very permeable and, like most flank flows of the major volcanoes of Hawaii Island, constitute aquifers of exceptional hydraulic characteristics. For the area between Kiholo and Puako, 12 to 22 miles north of Keahole hut including Hualalai lavas, Kanehiro and Peterson (1977) reported regional hydraulic conductivity of 3,369 feet per day as computed by tidal analysis and of 9,092 feet per day as computed from the flow equation in which the discharge was obtained by hydrologic budgeting. A probable outflow rate, from the lens, of 6.38 mgd/mile was calculated by the budget approach.

Hydraulic conductivity values of the above order are applicable to the Keahole region. Expressed as a range, hydraulic conductivity is likely to be greater than 2,000 feet per day but less than 10,000 feet per day; the probable regional value is 4,000 to 5,000 feet per day. On a local scale, of about 100 feet or less, the hydraulic conductivity may be very low or extremely high, but for aquifer analysis a regional value of 5,000 feet per

day is reasonable. Effective porosity of basalts cannot be conveniently measured; a conservative value of 0.10 is commonly employed.

Hawaiian basalt aquifers are anisotropic with respect to hydraulic conductivity. Estimates of the ratio of anisotropy have ranged from 5-1 to 200-1, horizontal to vertical. The basalts in the Keahole area are highly fractured, and in localized areas may transmit water more readily vertically than horizontally. The overall anisotropy would therefore be expected to be at the lower range, approximately 5-1.

The groundwater lens is characterized as an unconfined, thin lens with a typically flat gradient and a flow direction from the mountains toward the ocean. The 1980 University of Hawaii study showed that the coastal part of the lens experiences appreciable ocean tidal influence. At distances of up to 336 feet inland, tidal efficiencies ranges from 69 percent to 100 percent. Further inland at 600 feet, the efficiencies decreased to 43 to 68 percent. There is no simple accurate method for separating the tidal component from the head measurement to reveal the true groundwater head associated with the unidirectional ambient seaward flux. Also, it is not possible to measure the actual basal lens thickness without a drilled hole of sufficient depth. By applying the Ghyben-Herzberg ratio, however, the approximate thickness is calculated to be less than 125 feet within the area of concern.

CURRENT DISPOSAL METHOD AT ABALONE AQUACULTURE OPERATION

Current disposal at the NEHF abalone operation consists of approximately 1.2 mgd (800 gpm) through 2 injection wells and 0.3 mgd (200 gpm) through surface spreading.

The wells are 12-inch diameter, uncased holes augered to a depth of 20 feet from the existing ground surface, which is at approximately

Elevation +10. Three such wells were augered, but one well did not accept the required quantity of ocean discharge. The wells are submerged, and measurements of hydraulic response to injection were not possible.

The surface spreading occurs through a surface cinder layer placed over graded lava.

The relatively small quantities of water currently injected and the lack of hydraulic response data does not allow for useful extrapolation of the current operation to larger scale disposal.

The non-functioning of one of the drilled wells illustrates the high degree of local heterogeneity of the rock, where on a local scale, of about 100 feet or less, the hydraulic conductivity may be very low or extremely high.

Future expansion of the abalone aquaculture operation may increase discharge quantities to as much as 39 mgd (27,000 gpm).

ON-LAND OCEAN WATER DISPOSAL

The initial phase of HOST Park activities would generate an ocean water outflow quantity of about 20 mgd (13,900 gpm). The outflow quantity may increase to about 144 mgd (100,000 gpm) when the HOST Park is fully developed. The projected outflow quantity from the NEUH facilities may increase to about 39 mgd (27,000 gpm). Therefore, the combined maximum ocean water outflow quantity may eventually approach 183 mgd (127,000 gpm). However, it is envisioned that HOST and NEUH each will have their own ocean water disposal system.

Two possible schemes of on-land disposal have been studied to return the anticipated outflow quantity to the ocean. The two feasible disposal schemes are shallow surface trench disposal and deep well disposal. The two disposal schemes are similar in the basic engineering concept, which is to convert the

used ocean water into groundwater flow. The schemes would take advantage of the storage capacity, porosity, and the filtration effect of the lava formation to provide dispersion, diffusion and long residence time before the water is discharged to the ocean as underwater seepage flow along the coast. In addition, both disposal schemes would utilize gravity as the prime moving force and thus conserve energy.

The hydraulic and environmental impacts of the two on-land disposal schemes were evaluated by means of analytical computer modeling. The basic hydraulic parameters such as coefficient of storage, coefficient of transmissibility, porosity, hydraulic conductivity and transmissive flux were obtained from published data of the basaltic aquifer in the Keahole region. The detailed assumptions and findings are presented in the Appendix.

SHALLOW SURFACE TRENCH DISPOSAL

The proposed ocean water disposal area for HOST park is located approximately 2,000 feet from the shoreline. The ground surface elevation of the disposal area is about 40 feet above sea level.

For planning purposes, it is envisioned that the ocean water disposal trench will be approximately 10 feet wide, 10 feet deep and 100 feet long for the initial phase of the HOST Park development. The recommended length is about three times as long as the computed length of 34 feet. The extra trench length is to provide adequate allowance to mitigate silting and clogging problems that may occur in the initial start-up stage and also to provide planning flexibility and construction economy. It is estimated that at a constant disposal rate of 20 mgd for the initial phase, the trench will be less than half full.

The performance of the disposal trench should be monitored to collect operation and maintenance data for subsequent phases of the expansion program. Assuming that the technical parameters used in the theoretical computations can be validated by the actual performance, the disposal trench can then be incrementally extended to handle more disposal quantity as HOST Park grows in size. Theoretically, a disposal trench 10 feet wide, 10 feet deep, and 245 feet long could handle the maximum planned disposal quantity of 144 mgd. The available length of the disposal area is more than 900 feet.

It is envisioned that the disposal trench can be constructed using a large bulldozer such as Caterpillar D-9 or equivalent. A pneumatic ram attachment or blasting would be required to break up hard aa zones. The sides of the trench can be excavated near vertical. For safety reasons, the disposal trench area should be fenced. The trench can even be covered to preclude the congregation of birds and to retard algae growth. Foot bridges can be installed to provide personnel access for monitoring and maintenance.

For NELH facility, the location of the ocean water disposal area has not been determined. The likely location could be in an area at the south end of the NELH site and close to Keahole Airport boundary. The disposal trench can be planned in an orientation roughly parallel to and approximately 1,000 feet from the shoreline. The ground elevation in the area would be about 10 feet above sea level. For disposal of the maximum projected quantity of ocean water of 39 mgd, the theoretical trench dimensions would be 10 feet wide, 10 feet deep, and 175 feet long. For planning purposes, an ocean water disposal area 350 feet long should be reserved for NELH. The phasing of NELH activities is not known, therefore the sizing of the disposal trench would require additional study during design.

DEEP WELL DISPOSAL

Large diameter deep disposal wells have been used successfully in Hawaii to dispose of large quantities of treated industrial wastewater. For the initial phase of HOST Park disposal requirement of 20 mgd, it is estimated that 3 wells would be needed. To handle the anticipated maximum of 144 mgd of ocean water discharge to be generated at HOST Park, it is envisioned that about 15 wells would be required. The wells would be placed at the proposed ocean water disposal area in 2 or 3 rows roughly parallel to the shoring. The wells would be 2 feet in diameter, 100 feet deep and spaced at least 100 feet apart. The wells should be cased with slotted casings to prevent collapse and for ease of maintenance. It is estimated that each well could handle about 14.4 mgd (10,000 gpm). Therefore, for 20 mgd initial operation, only 2 of the 3 wells will be operating and for the maximum discharge of 144 mgd, only 10 wells are expected to be operating at the same time. The extra wells are standby capacity for planned maintenance or in case of 1 or more wells becoming inoperative due to clogging. The piping system and well head design would require careful engineering for smooth operation and ease of maintenance.

For NELH facility, similar deep disposal well concepts can be implemented. However, due to its low surface elevation, the injection rate is required to scale down to 11.5 mgd (8,000 gpm) per well to reduce well head build-up to below the ground surface. Alternatively, a forced injection system can be used. However, it would be a complex mechanical installation that would require continuous electrical energy consumption and frequent maintenance. Therefore, a forced injection system is not recommended for NELH.

Another variation to the large diameter deep well disposal scheme for NELH is the small diameter shallow gravity well system that has been used at the

abalone operation. Based on the known performance of the existing wells of 12 inches in diameter, 20 feet deep and uncased which currently dispose of about 0.58 mgd (400 gpm) per well, we estimate that it would require 100 operating shallow wells to handle the projected disposal quantity of 39 mgd.

EFFECTS OF ON-LAND OCEAN WATER DISPOSAL

The on-land disposal of ocean water would disrupt and displace the existing Ghyben-Herzberg lens for some distance inland and for a determinable width from the disposal area to the coast. The disposal water would travel as a plume surrounded by a zone of diffusion. Over the width of the plume, the disposed ocean water would dominate the discharge front at the coast.

To gain an understanding of the magnitude of the effects on ambient groundwater under massive disposal, analytical computer analyses of the plume formation were conducted. The disposed ocean water is assumed to be relatively free of biological material and entrained air. The basaltic aquifer is treated as if it were homogeneous and isotropic having an hydraulic conductivity of 5,000 feet/day and an effective porosity of 0.10. The ambient groundwater flow field is assigned a transmissive flux of 159.5 ft³/day/ft based on a coastal outflow of 6.3 mgd per mile in the area north of Keahole as reported by Kanehiro and Peterson (1977).

The ocean boundary is assumed to be parallel to the line of disposal trench or wells and is approximated by equivalent image pumping equidistant on the opposite side of the ocean boundary.

To estimate the limits of the plume, a solution presented by Bear (1979) for simultaneous injection and image pumping in a uniform flow field was used.

For the HOST Park Initial Increment of 20 mgd (13,900 gpm) the underground plume would be 2.7 miles wide at the shoreline and would reach 0.9 miles inland. For the total HOST Park discharge of 144 mgd (100,000 gpm) the plume would be 22.4 miles wide at the shoreline and would reach 2.4 miles inland. The shape of the plume created by 20 mgd disposal can be conceptualized as shown on Plate 1. These values are believed to be very conservative because the ambient groundwater and the heterogeneities of the lava formation would interfere with flow paths long before they could be realized. Also, the periods of injection required to reach theoretical limits are well in excess of the projected useful life of the facilities. However, the analyses indicate that the disposal of the projected quantity of ocean water on land would disrupt and displace the existing groundwater system in the near vicinity.

Similar results are obtained for the NELF and the HOST Park/NELF combination. The effects of the plumes are mitigated somewhat, as the discharges to the ocean would primarily occur along the coastline directly downstream of the disposal areas, and due to the time required for the disposed ocean water to completely displace ambient groundwater throughout the reach of the plumes.

The bulk of the groundwater to be displaced is ambient salt water which is presumed to have zero head relative to mean sea level datum, and its density and that of the disposed ocean water is assumed to be about the same. The major differences between the ambient groundwater and the disposed ocean water would likely to be salinity and temperature.

The shape of the disposal plume in the ground is difficult to visualize. For a homogeneous, isotropic aquifer, it could be envisioned that the plume would resemble an ever enlarging half sphere until it is truncated when in

contact with the ambient groundwater table and the coast. Due to aquifer anisotropy, among other factors, the plume could also be envisioned to resemble an ever enlarging cylinder. The depth of the cylinder would be governed by the anisotropy of the lava formation.

The residence time required for the disposed ocean water to reach the shore or other landmarks can be estimated by calculating the total effective volume of voids in the assumed disposal plume (either radiating spherical or radiating cylindrical model) and dividing it by the disposal rate. The formulae governing the computations are presented in the Appendix. The actual residence time is expected to lie within the range predicted by these two conceptual models. It has been estimated that for HOST Park facility disposal at 2,000 feet from shore, at a disposal rate of 20 mgd, it would require between 187 days and 3.6 years before the disposed ocean water re-emerged at the shoreline depending on whether the radiating sphere or radiating cylindrical model is assumed. At the maximum projected disposal rate of 144 mgd, the residence time would be reduced to between 26 and 144 days. To reach a distance of 1.5 miles, the approximate distance to anchialine ponds at Waihiwaaa Point, would require between 32 and 216 years at 20 mgd and between 4.4 and 30 years at 144 mgd.

The NEUH facility being closer to shore, the disposed ocean water would have a shorter residence time. Assuming shallow trench disposal of 39 mgd of ocean water at about 1,000 feet from shore, the residence time would be between 12 and 80 days.

The disposed ocean water would discharge at higher rates in the immediate downstream coastline of the disposal areas than at points further up and down the coast.

The discharges along the coastline can be estimated using Bear's (1979) stream function equation for injection and pumping in a uniform flow field.

It has been calculated that significant discharges are limited to approximately 8,000 feet up and down the coastline from the point approximately midway between the HOST and NEUH sites, for the combined NEUH/HOST Park injection case. For injection at the HOST Park only, significant discharge occurs up to 6,400 feet away, and injection at NEUH only results in significant discharge up to 4,000 feet away.

The discharge per unit area at the coastline varies with the distance along the coastline, with thickness of the plume at the coastline, and with the slope of the ocean bottom.

The maximum rate of discharge would occur immediately downstream of the disposal areas. For HOST Park only, assuming that the flow thickness would be 400 feet (for injection 2,000 feet from the shoreline and anisotropy of 5-1), and an offshore slope of 5 percent, the maximum transmissive flux of 1,900 ft²/day would be discharged over a distance of 6,400 feet offshore. The discharge per square foot would average 0.3 ft³/day (2.2 gallons/square foot/day).

At the NEUH facility, assuming that the flow thickness would be 200 feet (for injection 1,000 feet from the shoreline and anisotropy of 5-1), the maximum transmission flux of 2,400 ft²/day would be discharged over a distance of 4,000 feet offshore. The discharge per square foot would average 0.6 ft³/day (4.5 gallons/square foot/day).

For combined NEUH/HOST Park injection, assuming that the flow thickness would be 300 feet (for average injection distance of 1,500 feet from the shoreline and anisotropy of 5-1) the maximum transmissive flux of 3,900 ft²/day would be discharged over a distance of 8,000 feet offshore.

The discharge per square foot would average 0.49 ft³/day (3.6 gallons/square foot/day).

WATER QUALITY MONITORING DURING OPERATION

It is recommended that a water quality monitoring program be implemented to obtain factual data on the effects of on-land ocean water disposal. Based on the estimated time for the disposal plume to reach the shoreline in six months to 3.6 years after the start of HOST Park initial activities, it is believed that a minimum four year monitoring program, consisting of initial sampling followed by semi-annual resampling after the start of injection, would provide invaluable technical data to further improve the on-land ocean water disposal concept.

The water quality monitoring program should include periodic water level measurement and water sampling and analysis the disposal area, at two or more on-land locations downstream of the disposal area and at several locations along the shoreline and offshore. Basic water quality parameters to be collected should include temperature, salinity, turbidity, nutrient content, fecal contents, and other pertinent information such as disposal rate, precipitation, tides and evapotranspiration.

COST EFFECTIVENESS OF ON-LAND DISPOSAL SCHEMES

The shallow trench disposal and the deep well disposal schemes both appear to be feasible in disposing of large quantities of ocean water. In both schemes, the effect would be similar: nearly complete disruption of the existing groundwater lens and the formation of a wide ranging plume which discharges to the ocean along the shoreline bottom for a considerable distance offshore.

The magnitude of injection is such that there is little or no difference in environmental effects between disposal by trenches or wells. Therefore, the selection of an alternative for physical subsurface disposal would be based primarily on cost effectiveness and ease of maintenance.

Disposal by surface trenches have significant advantages in both of these areas over disposal by wells. Trench construction costs are significantly lower. Based on the known cost of lava excavation at the abalone operation of \$15/cu. yd., it is estimated that excavating a disposal trench 10 feet wide and 10 feet deep would cost about \$60 to \$70 per linear foot. Therefore, for the initial phase of HOST Park development, a 100-foot long disposal trench is estimated to cost about \$6,000 to \$7,000. In comparison, three 2-foot diameter, 100-foot deep, cased disposal wells would cost about \$30,000 apiece, or \$90,000 for the initial phase. Therefore, trenches will cost 13 to 15 times less than deep wells. The cost advantage may be reduced somewhat if the cost of land is included.

We anticipate that clogging will occur for either trenches or wells, because the ocean water is planned for aquaculture use. It is anticipated that nutrients, entrained air, and suspended solids, all contributors to primary clogging or secondary biologically fouling, would be found in the ocean water return. Maintenance and/or replacement will therefore be required for both schemes. Although deep well disposal is likely to be less affected by secondary biological fouling, maintenance of surface trenches, probably consisting of periodic regrading of the trench bottom, is expected to be easier and less expensive than maintenance and/or replacement of wells.

TREATMENT OF OCEAN WATER

The clogging potential of disposal facilities and the aquifer can be minimized if there are no significant alterations of certain quality parameters in the ocean water return: nutrients (nitrogen and phosphorus), suspended solids (volatile and inorganic), bacteria, and entrained air. Given the reported high concentration of nutrients in the deep ocean water, algal and bacterial growths which will result in clogging slimes, are expected. Therefore, environmental factors, such as sunlight, which encourage growths should be controlled.

Minute air bubbles produced by excessive turbulence and entrained air in the ocean water discharge can produce air binding in the aquifer and should be minimized by the hydraulic design of the system. Additives including chlorine and corrosion inhibitors pose no problems to the disposal system but biofouling-produced materials may have potential for clogging. Liquid and solid wastes, such as sewage, grease, oil, and laboratory chemicals (toxic or otherwise), should be collected and managed in separate waste water treatment and disposal systems.

It is recommended that each user of the ocean water be responsible for treatment before the return water is diverted to the ocean water disposal area. At the ocean water disposal area, filtration beds and lined settling ponds can be added to filter out solids and remove entrained air before the return water is entered into the disposal trench or wells. Since the expected usage of the deep ocean water at HOST Park and NELH facilities is primarily related to aquaculture, it is believed that treatment of the return water would be conventional and could be designed when the usage becomes known.

EFFECTS OF DOMESTIC SEWAGE DISPOSAL SYSTEMS

It is expected that the quantity of domestic sewage to be generated is estimated at 460 gallons/acre/day. For the 460 acre HOST Park, approximately 211,000 gpd would be generated. According to the current planning, cesspools would not be allowed. All domestic sewage would be handled by the use of septic tanks and leaching fields for disposal. The use of septic tanks would greatly reduce the risk of uncontrolled flow of contaminants. The use of leaching fields would take advantage of the high evapotranspiration in the region to dispose of a large percentage of the sewage. A properly designed leaching field could actually support a healthy growth of green lawn around the facility.

Any remaining sewage that is percolated down to the groundwater would be insignificant compared to the projected volume of ocean water disposal plume. The additional effects on the groundwater, plus the effects already imposed by the ocean water plume, would not be significant.

Sewage effluent entering the groundwater regime between the ocean water disposal plume and the ocean would be discharged at the shoreline in the vicinity of NELH or HOST park. Prior to discharge, the effluent would be significantly diluted by the large quantities of flowing ocean water return, and would be somewhat filtered and biologically digested during its residence time in the subsurface.

Sewage entering the groundwater regime north of the disposal plume would likely be carried inland and laterally some distance along the coastline before final discharge to the ocean. The resulting extended residence time (many years), and resulting high degree of filtering and biological digestion would minimize effects on the ocean.

IMPACT OF SURGE LOADS OF ACIDS AND CHEMICALS

Based on discussions with NELH personnel, surge loads of acids and chemicals are not likely due to the nature of aquaculture operations. Such loads, if they were to occur, would be highly diluted by the immense quantities of ocean water return and would have insignificant effects. Acids would be buffered nearly immediately by the ocean water and would have minimal effect.

EFFECTS OF CONCENTRATED SURFACE RUNOFF

At the mauka boundary of HOST Park, there are two 96-inch diameter corrugated drainage culverts crossing Queen Kaahumanu Highway. These two culverts are designed to handle 100-year event storm runoff. According to the civil engineering consultant, these two culverts at full flow could carry a discharge up to 1,250 cfs or an equivalent of 807 mgd. The civil engineer has recommended a drainage ditch be constructed downstream of these culverts to channelize the flow into the ocean. It is conceivable that the storm water could totally percolate through the unlined drainage ditch before it reaches the ocean. The storm water would eventually merge with the ocean water plume and discharge into the ocean. Due to low annual rainfall in the region and the infrequent occurrence of large rain storms, it is believed that the stormwater infiltration would have insignificant effect on the quality and quantity of the ocean water disposal plume.

MITIGATION OF ADVERSE EFFECTS

The primary effect caused by the large quantity of ocean water disposal would be the disruption and displacement of the existing brackish water lens. The lens is unsuitable for groundwater development, but apparently is the

source of water for some stands of kiawe trees located north of Keahole Point, and in the vicinity of Waiolohi Beach. Trees that have deep root systems that reach the groundwater level probably would not survive the displacement of the brackish water lens by the saline ocean water plume.

The brackish water lens also is the source of water for some anchialine ponds in the vicinity of Waioli Point approximately 1.5 miles south of the proposed ocean water disposal area of the HOST park. These ponds are within the projected disposal plume, and may begin to become more brackish, then saline, after some years. The length of time would depend upon the rate of development of the HOST park and NELH facilities. Assuming that incremental development of the park would occur, expansion of the plume 1.5 miles of the HOST Park would take approximately 15 to 20 years.

The effects on the brackish water lens cannot be mitigated except by foregoing on-land ocean water disposal.

The discharge of the ocean water return into the ocean would have insignificant effects. The rate of discharge per unit area is minimal and the ocean water return would be nearly indistinguishable from the ocean water it is merging with.

Attachment - Approximate Underground Ocean Water Disposal Plume at HOST Park at 20 mgd Disposal Rate.

Appendix - Hydraulics of On-Land Ocean Water Disposal

REFERENCES

Adams, W. H.; Peterson, F. L.; Mathur, S. P.; Lepley, L. K.; Warren, C.; and Huber, R. D.; 1969. A hydrogeophysical survey from Kawafae to Kailua-Kona, Hawaii. Tech. Rep. No. 32, Water Resources Research Center, University of Hawaii.

Beat, J.; 1979. Hydraulics of Groundwater. McGraw Hill, New York.

Kanahiro, B. Y. and Peterson, F. L., 1977. Groundwater recharge and coastal discharge for the northwest coast of the Island of Hawaii, a computerized water budget approach. Tech. Rep. No. 110, Water Resources Research Center, University of Hawaii.

Kay, E. A.; Law, L. S.; Stroup, E. D.; Dollar, S. J.; Fellows, D. P.; and Young, R. H. F., 1977. Hydrologic and economical inventories of the coastal waters of West Hawaii. Tech. Rep. No. 105, Water Resources Research Center, University of Hawaii.

Maciulek, J. A., and Brock, R. E., 1974. Aquatic survey of the Kona coast ponds, Hawaii Island. Sea Grant AR-74-04. Sea Grant College Program, University of Hawaii.

Stearns, H. T., and Macdonald, G. A., 1946. Geology and ground-water resources of the Island of Hawaii. Bull. 9, Hawaii Division of Hydrology.

Water Resources Research Center, University of Hawaii, 1980, Proposed Prototype Testing Program, Land Disposal by Injection Wells of Ocean Water Effluent at Seacoast Test Facility, Keahole Point, Hawaii Island.

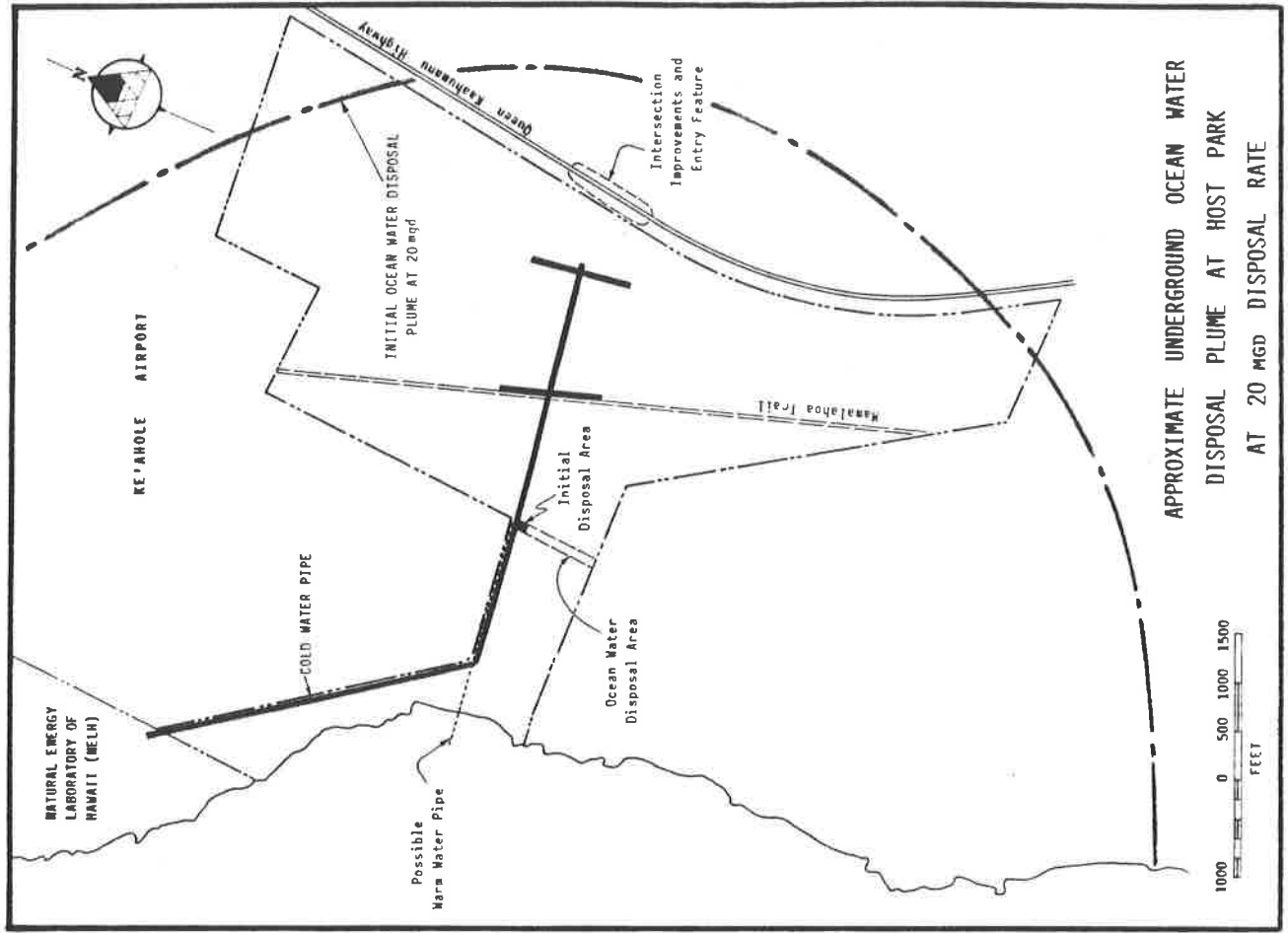

APPROXIMATE UNDERGROUND OCEAN WATER
DISPOSAL PLUME AT HOST PARK
AT 20 MGD DISPOSAL RATE

10-27-80 100-20641

APPENDIX

HYDRAULICS OF ON-LAND OCEAN WATER DISPOSAL

1. Known Hydraulic Parameters and Assumptions.

- a) The transmissive flex along the coastline in the area north of Keshole was about 6.3 mgd per mile or 159.5 ft³/day/ft as derived by Kanehiro and Peterson (1977). This value is assumed to be applicable to the coastline at HOST park and NELH.
- b) The regional hydraulic conductivity k is assumed to be 5,000 ft/day. Hydraulic conductivity values reported by Kanehiro and Peterson (1977) were 3,369 ft/day as computed by tidal analysis and 9,032 ft/day as computed from the flow equation.
- c) The effective porosity n of lava formations is assumed to be 0.10.
- d) The ocean water to be disposed is assumed to be relatively free of solids, contaminants and entrained air. Filtration and settling ponds may be required as pre-treatment procedures prior to disposal.

2. Shallow Trench Disposal at NELH Site.

For shallow trench disposal at the NELH Site, it is assumed that the trench would be 10 feet wide and 10 feet deep and the trench bottom may be in direct contact with the groundwater level because of low ground elevation.

Total disposal quantity equation for the half-cylinder shaped plume

is:

$$Q = k \cdot \pi \cdot s \cdot x / \ln \left[\frac{r_e}{r_o} \right] \quad (1)$$

- where, Q = the total disposal quantity = 39 mgd = 27,000 gpm
- k = hydraulic conductivity = 5,000 ft/day
- π = 3.1416
- s = injection head = 10 ft
- x = length of trench
- r_e = distance from the trench to the coastline = 1,000 ft
- r_o = half width of the trench = 5 ft

Solving the equation for x yields a trench length of 175 feet.

3. Shallow Trench Disposal at HOST Park Site.

For shallow trench disposal at HOST Park site, it is also assumed that the trench would be 10 feet wide and 10 feet deep. The disposal site would be located about 2,000 feet from the coastline and the ground elevation in the area would be about 40 feet above the sea level. It is envisioned that the disposal water is likely to percolate vertically downward and be transformed into a disposal plume to displace the ambient groundwater. The relevant equation would be:

$$Q = (k \cdot \pi \cdot r_o \cdot x) \cdot \frac{dh}{dr} \quad (2)$$

- where, Q = the total disposal quantity
- k = hydraulic conductivity = 5,000 ft/day
- π = 3.1416
- r_o = half width of the trench = 5 ft
- x = length of trench
- dh/dr = flow gradient = 1 (vertical percolation)

Solving the equation for x yields a trench length of 34 feet for the disposal quantity of 20 mgd and 245 feet for the disposal quantity of 144 mgd.

4. Deep Well Disposal.

The feasibility of ocean water disposal by wells was examined by using the Theis non-equilibrium equation:

$$s = \frac{Q}{4} \int \frac{e^{-u}}{u} \cdot du \tag{3}$$

where, s = drawdown or build up of water level in a well

Q = disposal rate

T = coefficient of transmissibility

u = $r^2 \cdot S / 4 \cdot T \cdot t$

where, S = coefficient of storage

t = time since disposal started

r = distance from well

A computer program, consisting of a solution of the Theis non-equilibrium equation modified to include the interference effects from multiple wells, was applied to study the hydraulics of disposal by wells.

The following hydraulic properties were used for the lava formation: the coefficient of transmissibility (T), 7,480,000 gpd/foot (for K = 5,000 ft/day), effective aquifer thickness in well vicinity of 200 feet; the coefficient of storage (S), 0.1.

Water level rise in the wells for the given rate of disposal were computed. The effects of interaction between wells were considered using the principle of superposition.

The computer model, based on the Theis equation and the superposition principle was applied with the following assumptions:

- a. Wells are 2 feet in diameter and 100 feet deep each;
- b. 10 wells discharging 14.4 mgd (10,000 gpm) each;
- c. Well spacing of 100 feet;
- d. Wells are on a line parallel to the ocean, 2,000 feet from the shoreline.

The ocean boundary was modeled using image pumping wells located equidistant from and on the opposite site of the ocean boundary.

The computed hydraulic head buildups at the 10 wells ranging from 8.6 to 9.8 feet. A design head buildup of 10 feet is recommended to allow for head losses of the well casings. Therefore, ten wells spaced 100 feet apart appear to be suitable for planning purposes for the HOST Park.

5. Disposal Plume Analysis.

To estimate the limits of the plume, a solution presented by Bear (1979) of simultaneous injection and image pumping in a uniform flow field was used. The solution flow net is illustrated on Plate 1.

For the potential function ϕ , at $y = 0$;

$$\phi = \frac{-q_{OB}}{T} (x) + \frac{Q_w}{2\pi T} \cdot \ln \frac{(x+d)^2}{(x-d)^2} \tag{4}$$

For the stream function ψ , at $x = 0$;

$$\psi = \frac{-q_{OB}}{T} (y) + \frac{Q_w}{2\pi T} \cdot \left\{ \tan^{-1} \left[\frac{y}{d} \right] - \tan^{-1} \left[\frac{y}{-d} \right] \right\} \tag{5}$$

The above equations are based on injection at $y = 0$, $x = d$; pumping at the image location of $y = 0$, $x = -d$; and a uniform flow field parallel to the x axis in the $-x$ direction.

The value of q_0B is a constant equal to $159.5 \text{ ft}^2/\text{day}$, the transmissive flux due to the natural groundwater flow.

The width of the plume would be defined by y when $\psi = 0$. The inland reach of the plume is defined by x when $\phi = 0$.

The resulting functions were programmed, resulting in an analytical computer model which allows examination of the variation in the size of the plume with discharge rates.

The results of the analyses are presented on Plates 2 through 7, which give plume width and inland reach as a function of the disposal rate, for three cases:

- 1) Disposal area 2,000 feet from the shoreline for the MOST Park
- 2) Disposal area 1,000 feet from the shoreline for NPLH; and
- 3) Disposal area at an average distance of 1,500 feet from the shoreline for a combination of the two.

6. Residence Time Computation for Enlarging Sphere Model.

Point disposal of a volume per unit time is expressed as:

$$Q \cdot dt = \frac{4 \cdot n \cdot \pi \cdot (r+dr)^3}{3} - \frac{4 \cdot n \cdot \pi \cdot r^3}{3} \quad (6)$$

where, Q = constant rate of disposal
 r = distance from point of disposal
 n = effective porosity = 0.10
 t = residence time

Eliminating the higher degree differentials give:

$$Q \cdot dt = 4 \cdot n \cdot \pi \cdot r^2 \cdot dr \quad (7)$$

and by integration,

$$r = \left(\frac{3 \cdot Q \cdot t}{4 \cdot n \cdot \pi} \right)^{1/3} \quad (8)$$

or
$$t = \frac{4 \cdot n \cdot \pi \cdot r^3}{3 \cdot Q} \quad (9)$$

7. Residence Time Computation for Enlarging Cylinder Model.

The plume formed is envisioned to be an ever enlarging cylinder. The governing equation is

$$r = (Q \cdot t / n \cdot \pi \cdot z)^{1/2} \quad (10)$$

$$t = \frac{n \cdot z \cdot \pi \cdot r^2}{Q} \quad (11)$$

where, n = effective porosity = 0.10
 z = aquifer thickness, for anisotropy of 5 horizontal to 1 vertical, z would be 400 feet for a flow distance of 2,000 feet to the shoreline.

π = 3.1416
 r = distance to shoreline
 Q = constant rate of disposal

8. Computation of Discharges at the Shoreline.

The discharges along the shoreline can be estimated using Bear's (1979) stream function equation for injection and pumping in a uniform flow field shown as equation 5.

By definition, the flow between two points is equal to the difference in the stream functions at those points. Use of equation (5) enables calculation of stream function at various distances along the shoreline.

For the HOST Park site $x = 2,000$ ft, $y = 0$. For the NEIH site $x = 1,000$ ft and $y = 0$. For HOST/NEIH combined average $x = 1,500$ and $y = 0$. The differences between stream functions were calculated, normalized, and plotted as shown on Plates 8 to 10.

The following Plates are attached and completes this appendix.

- Plate 1 - Recharge and Image Pumping in a Uniform Flow Field
- Plate 2 - Theoretical Plume Width vs. Injection Rate (Injection 2,000 feet from shoreline at HOST Park)
- Plate 3 - Theoretical Inland Reach of Plume vs. Injection Rate (Injection 2,000 feet from shoreline at HOST Park)
- Plate 4 - Theoretical Plume Width vs. Injection Rate (Injection 1,000 feet from shoreline at NEIH)
- Plate 5 - Theoretical Inland Reach of Plume vs. Injection Rate (Injection 1,000 feet from shoreline at NEIH)
- Plate 6 - Theoretical Plume Width vs. Injection Rate (Average injection 1,500 feet from shoreline, combination HOST Park and NEIH)
- Plate 7 - Theoretical Inland Reach of Plume vs. Injection Rate (Average Injection 1,500 feet from shoreline, combination HOST Park and NEIH)
- Plate 8 - Normalized Shoreline Distribution of Ocean Water Return Discharge (Injection 2,000 feet from shoreline at HOST Park)
- Plate 9 - Normalized Shoreline Distribution of Ocean Water Return Discharge (Injection 1,000 feet from shoreline at NEIH)
- Plate 10 - Normalized Shoreline Distribution of Ocean Water Return Discharge (Average injection 1,500 feet from shoreline, combination HOST Park and NEIH)

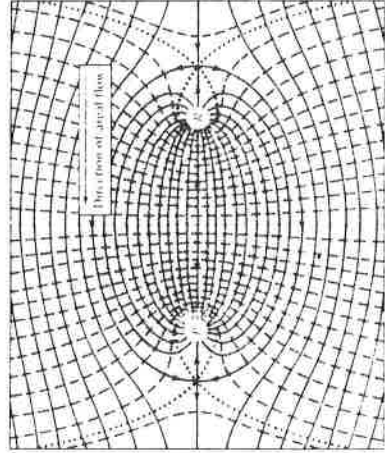

REFERENCE: Bear, 1979

RECHARGE AND IMAGE PUMPING IN A UNIFORM FLOW FIELD

REVISIONS BY DATE

1468-001 FILE

DATE BY CHECKED BY

BY _____ DATE _____
 CHECKED BY _____

FILE _____

REVISIONS
 BY _____ DATE _____

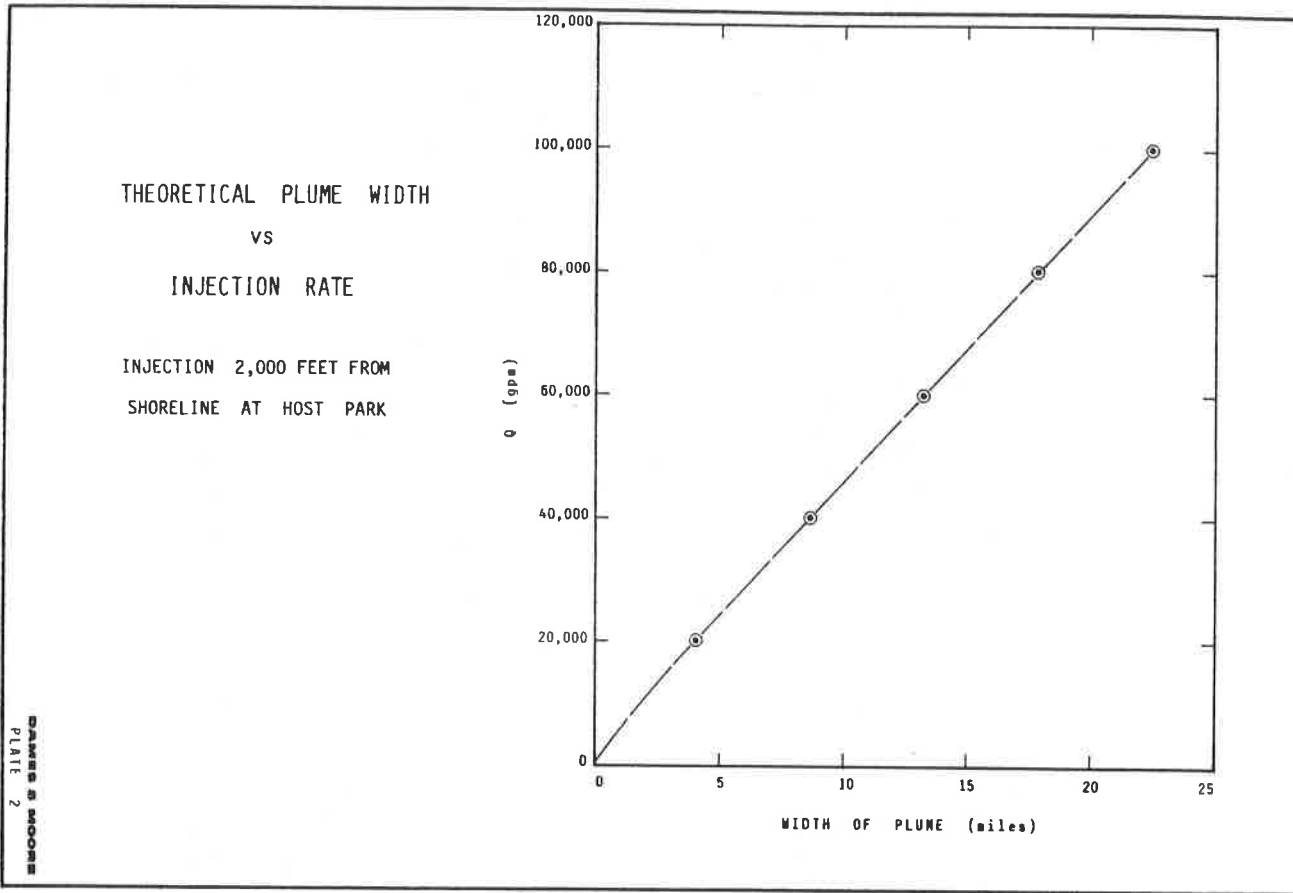

BY lf DATE 1-5-85
 CHECKED BY _____

FILE 14409-001

REVISIONS
 BY _____ DATE _____

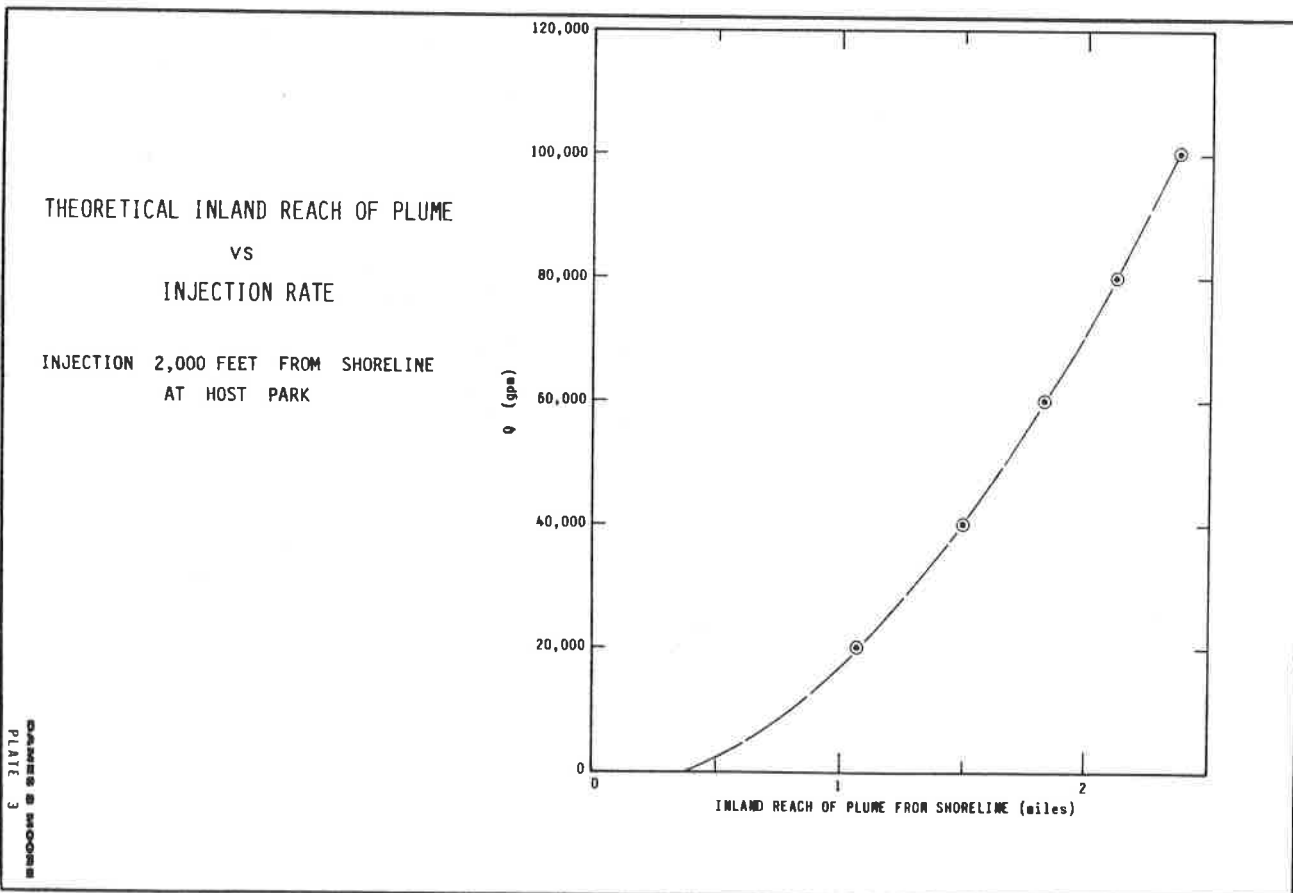

BY _____ DATE _____
CHECKED BY _____

FILE _____

REVISIONS
BY _____ DATE _____

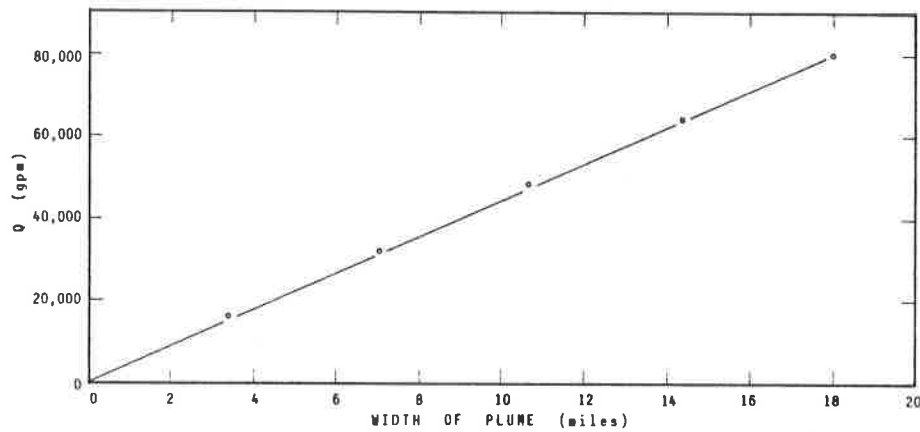

THEORETICAL PLUME WIDTH vs INJECTION RATE
INJECTION 1,000 FEET FROM SHORELINE AT NELH

DAVIS & MOORE
PLATE 4

BY _____ DATE _____
CHECKED BY _____

FILE _____

REVISIONS
BY _____ DATE _____

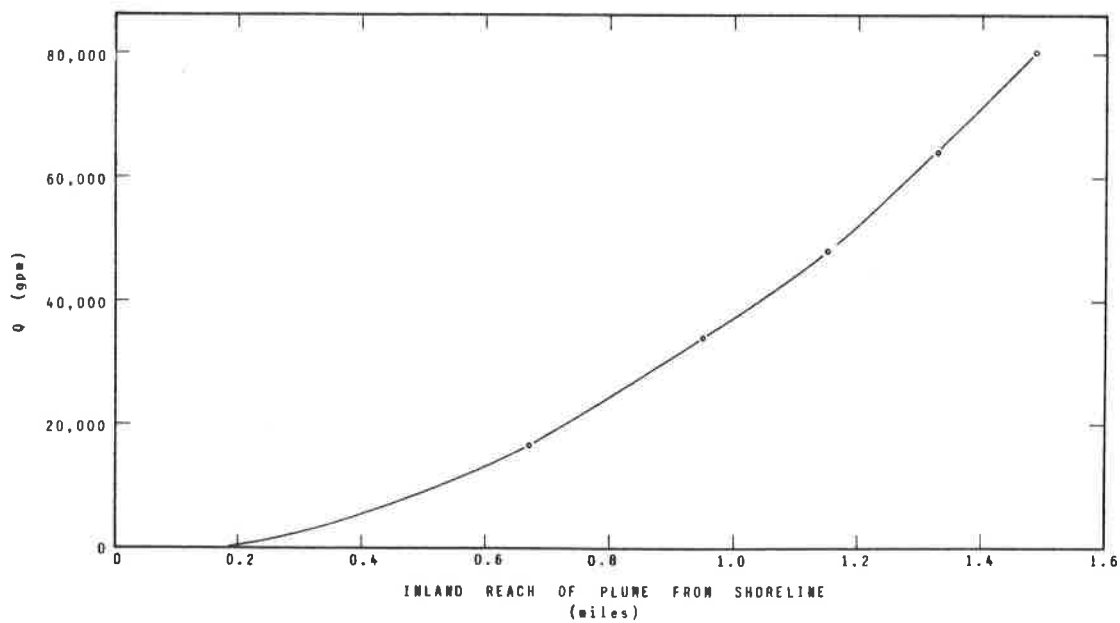

THEORETICAL INLAND REACH OF PLUME vs INJECTION RATE
INJECTION 1,000 FEET FROM SHORELINE AT NELH

DAVIS & MOORE
PLATE 5

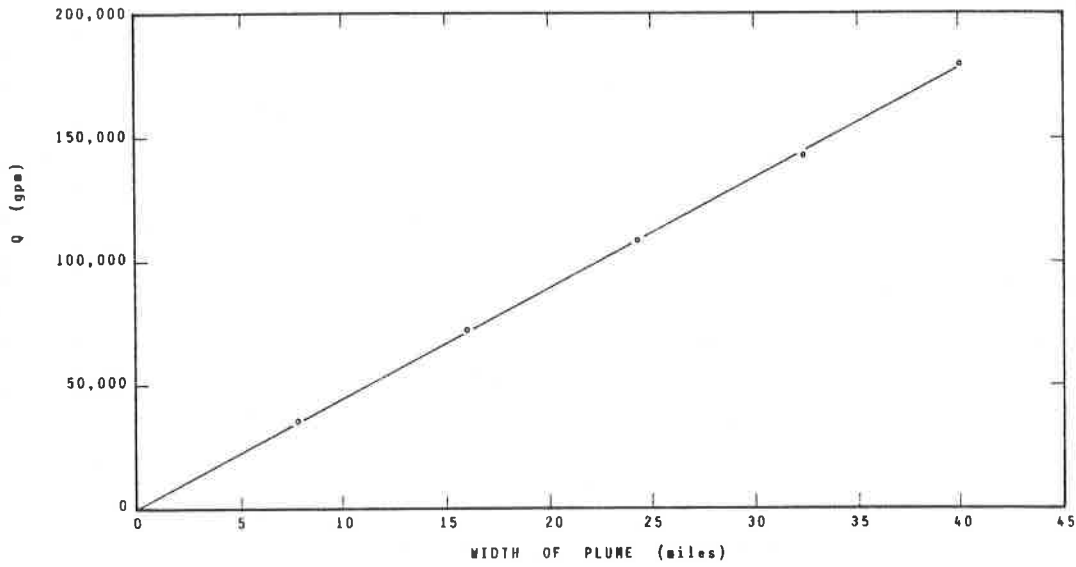

THEORETICAL PLUME WIDTH vs INJECTION RATE
 AVERAGE INJECTION 1,500 FEET FROM SHORELINE
 (Combination HOST Park and NELH)

DAVIS & BROOKS
PLATE 6

THEORETICAL INLAND REACH
 OF PLUME vs INJECTION RATE
 AVERAGE INJECTION 1,500 FEET
 FROM SHORELINE
 (Combination HOST Park
 and NELH)

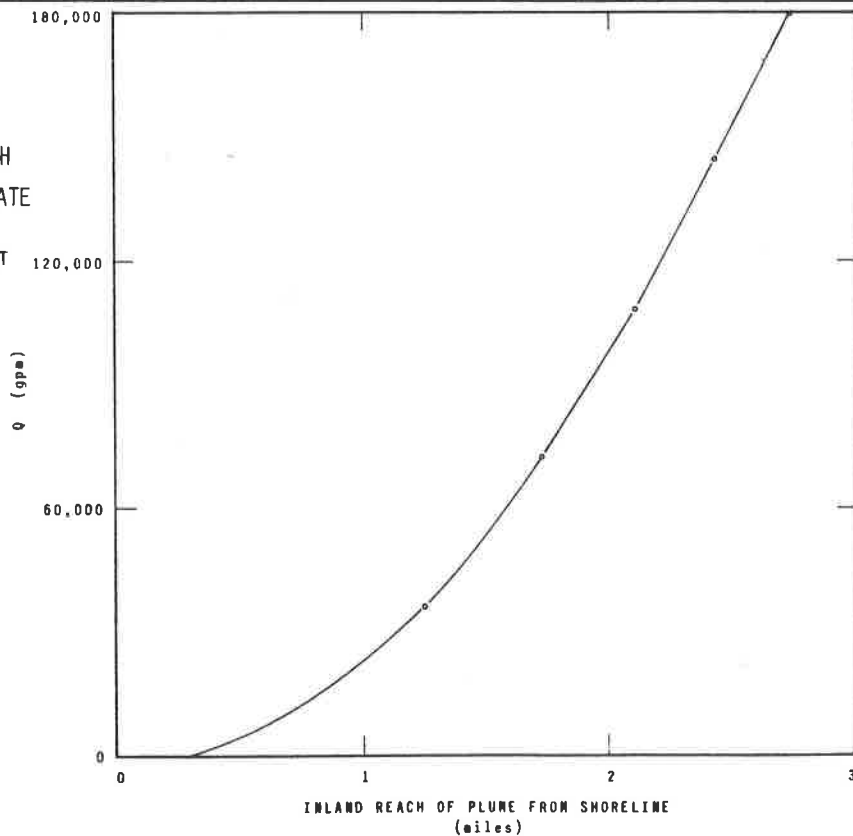

DAVIS & BROOKS
PLATE 7

BY DATE
CHECKED BY

FILE

REVISIONS
BY DATE

NORMALIZED SHORELINE DISTRIBUTION OF OCEAN WATER RETURN DISCHARGE

INJECTION 2,000 FEET FROM
SHORELINE AT HOST PARK

$\Delta\psi$ (normalized stream function
difference vs. distance along
coastline)

$\Delta\psi = 1$ is equivalent to
1,900 ft³/day/ft of
coastline

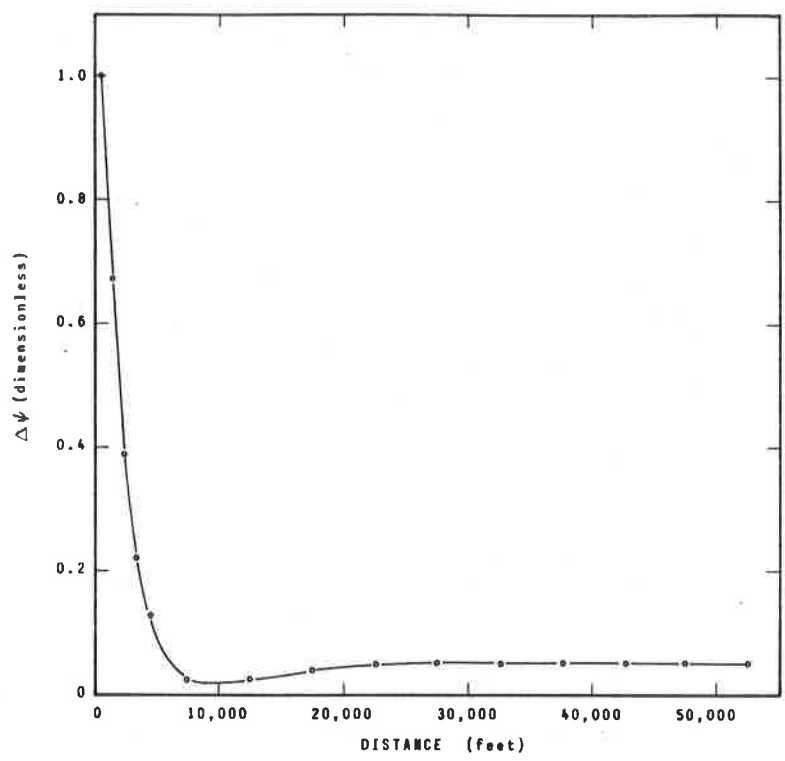

DANIELS & MOORE
PLATE 8

BY DATE
CHECKED BY

FILE

REVISIONS
BY DATE

NORMALIZED SHORELINE DISTRIBUTION OF OCEAN WATER RETURN DISCHARGE

INJECTION 1,000 FEET FROM
SHORELINE AT NELH

$\Delta\psi$ (normalized stream function
difference vs. distance along
shoreline)

$\Delta\psi = 1$ is equivalent to 2,400 ft³/day/ft
of shoreline

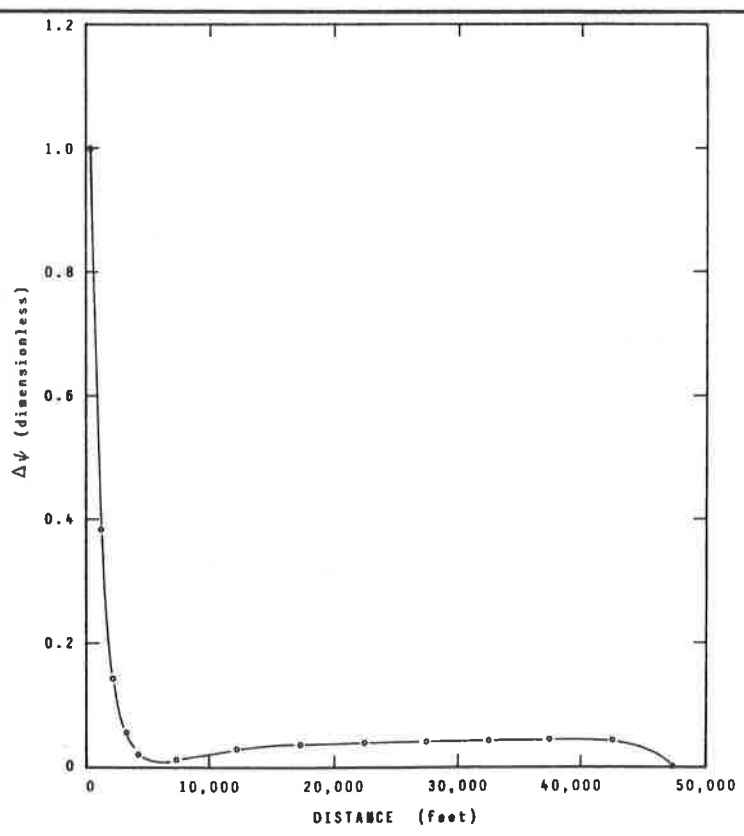

DANIELS & MOORE
PLATE 9

$\Delta\psi$ (normalized stream function difference vs. distance along coastline)

$\Delta\psi = 1$ is equivalent to $3,900 \text{ ft}^3/\text{day}/\text{ft}$ of shoreline

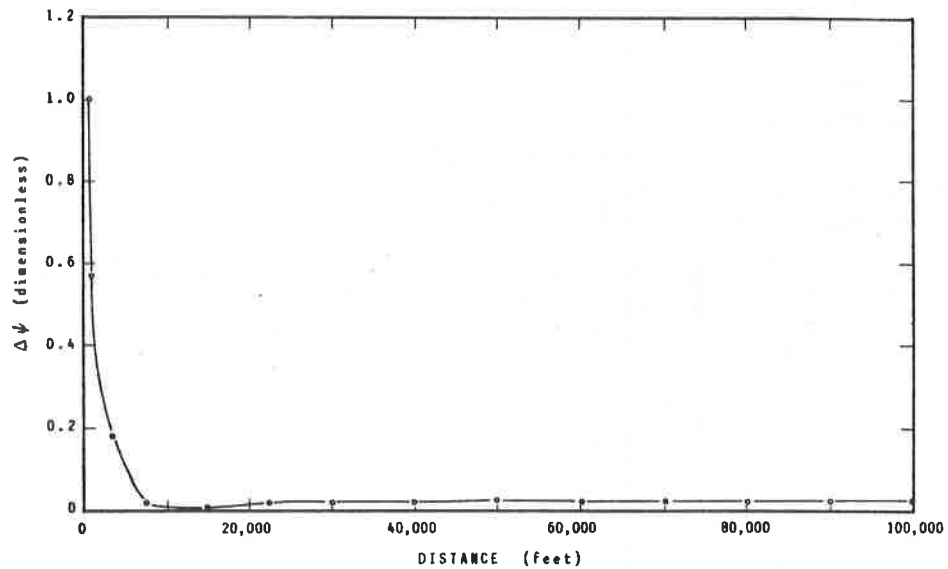

NORMALIZED SHORELINE DISTRIBUTION OF OCEAN WATER RETURN DISCHARGE

AVERAGE INJECTION 1,500 FEET FROM SHORELINE
(Combination HOST Park and NELH)

APPENDIX D

VEGETATION AND TERRESTRIAL FAUNA
AT NELH/HOST PARK

CHAR & ASSOCIATES
JUNE 1985

VEGETATION AND TERRESTRIAL FAUNA AT NELH/HOST PARK

VEGETATION

INTRODUCTION

The project area is located on the dry leeward coast of West Hawai'i. The average annual rainfall is 16 to 17 inches per year and vegetation is sparse. Lava flows of different ages cover most of the project area. Parts of the Natural Energy Laboratory of Hawaii (NELH) facilities are located on the 1801 lava flow which originated upslope near Hu'e'hue. The proposed Hawaii Ocean Science and Technology (HOST) Park is located on prehistoric pahoehoe and 'a'ua lava flows (Macdonald and Abbott, 1970). Plant establishment and succession on lava flows in dry localities is exceedingly slow, requiring hundreds of years. In contrast, plant succession on lava flows in wet localities such as Puna is relatively "fast." An open 'ohi'a (*Metrosideros collina*) forest can develop on a bare 'a'ua flow within 120 years (Atkinson 1970, Smathers and Mueller-Dombois 1974).

VEGETATION DESCRIPTION

There have been a number of botanical surveys made on the NELH property and nearby areas. Walker (1975, 1976) made an intensive flora and fauna survey of the NELH site as well as the adjoining Waiwai Beach and the planned access road and utility corridor. Krauss (1977) conducted a botanical survey of the Ke'ahole Agricultural Park area which lies immediately mauka (east) of the HOST Park. The following discussion is largely drawn from Walker (1975, 1976) and Krauss (1977).

Three types of vegetation are recognized within the project area and are described below.

Strand Vegetation: The strand or beach zone vegetation forms a narrow to somewhat wide (up to 300 ft. in width) belt along the coast. The substrata may consist of white sand or boulder and coral rubble deposited by storms. Clusters of *naupaka* (*Scaevola taccada*) shrubs are frequently encountered. A few scattered, windswept thickets of *kiawe* (*Prosopis pallida*) are occasionally found along the landward edge of the strand. Other species found along the shore include *hi'aloa* (*Waltheria indica* var. *americana*), beach morning glory (*Ipomoea brasiliensis*), Bermuda grass or *manienie* (*Cynodon dactylon*), and tree heliotrope (*Messerschmidia argentea*).

Vegetation on the 1801 flow: Vegetation on the 1801 pahoehoe lava flow is very sparse and scattered, most of the plants occurring along the edge of the flow. Plant species found on the flow include fountaingrass (*Pennisetum setaceum*), the native caper or *maiapilo* (*Capparis sandwicheana*) var. *zoharyi*, swordfern (*Nephrolepis multiflora*), and *hi'aloa*. Where the flow meets the ocean, the shoreline consists of 5 to 20 ft. high sheet basalt cliffs (Nolan and Cheney, 1981) which are largely devoid of vegetation.

Dry grass-scrub community: This type of vegetation is found on the weathered, prehistoric flows composed principally of pahoehoe lava. It consists of a somewhat sparse cover of fountaingrass and scattered shrubs. Native shrubs and subshrubs found here include 'a'ali'i (*Dodonaea viscosa*), 'ilima (*Sida fallax*), *naio* (*Myoporum sandwicense*), *alaha'e* (*Canthium odoratum*), *hi'aloa*, and *maiapilo*; exotic shrubs include *lantana* (*Lantana camara*), *indigo* (*Indigofera suffruticosa*), *klu* (*Acacia*

farnesiana), and Christmas berry (*Schinus terebinthifolius*). *Noni* (*Morinda citrifolia*), a Polynesian introduction, is also occasionally observed on the old lava flows. Weedy forbs, vines and grasses such as Australian vervain (*Stachytarpheta australis*), *coabuttons* (*Trixis procumbens*), *lauki* (*Cassia lechenaulliana*), *balaram* apple (*Miomodica charantia* var. *paveli*), *Paspalum foetida*, Japanese lovegrass (*Eragrostis tenella*), *natal redtop* (*Rhynchosyris repens*), and pigweed (*Portulaca oleracea*) may also occur here. A few scattered patches of swordfern can occasionally be found in cracks and crevices.

RECOMMENDATIONS

Vegetation on the project area is generally sparse and scattered. No rare, threatened or endangered plant species have been recorded from the project area. The native species that are found on the project site also occur in similar habitats throughout the West Hawai'i area. The proposed development of the HOST Park and expansion of the NELH facilities will have a minimal impact on the total island populations of the native components.

The ocean water supply pipes which will cross the strand vegetation are of some concern. Wherever possible, the pipes should be sited so that they do not cross over vegetated areas. If vegetation must be disturbed then the area should be replanted immediately to stabilize the sand.

REFERENCES

- Atkinson, J.A.E. 1970. Successional trends in the coastal and lowland forest of Mauna Loa and Kilauea Volcanoes, Hawaii. Pacific Science 24(3): 387-400.
- Krauss, B. 1977. Report of flora and fauna survey at Keahole, Kona, Hawaii. Prepared for M & E Pacific, Inc. August 1977.
- Macdonald, C.A. and A.T. Abbott. 1970. Volcanoes in the sea, Univ. Press of Hawaii, Honolulu.
- Nolan, R.S. and D.P. Cheney. 1981. West Hawaii Coral Reef Inventory, ORCA-Ocean Research Consulting & Analysis, Ltd. Prepared for the Army Corps of Engineers, Pacific Division.
- Smathers, G.A. and D. Mueller-Dombois. 1974. Invasion and recovery of vegetation after a volcanic eruption in Hawaii. National Park Service Scientific Monograph Series, No. 5, Publ. No. NPS 118.
- Walker, R.L. 1975. Flora and fauna of the Ke'ahole Point Natural Energy Laboratory Site, Island of Hawaii. November 1975.
- Walker, R.L. 1976. Flora and fauna. In R. M. Towill, Environmental Assessment of the Natural Energy Laboratory of Hawaii at Ke-Ahole Point, Hawaii. Prepared for the Research Corporation of the University of Hawaii. January 1976.

TERRESTRIAL FAUNA

INTRODUCTION

The project area is sparsely vegetated and supports a low concentration of wildlife. Most species are commonly found along the coastal zone or sometimes in the grass-scrub community on the old lava flows. Wildlife was rarely observed on the 1801 lava flow.

A fauna survey of the NELH site, Waiwaioli Beach, and the planned access road and utility corridor was made by Walker in November 1975. Krauss (1977) presented some observations on the fauna of the nearby Ke-ahole Agricultural Park.

The following discussion is based largely on the Walker survey (1975).

AVIFAUNA

Endemic birds -- No endemic Hawaiian birds were observed on the NELH site by Walker (1975); however, Krauss (1977) did see one Hawaiian owl or pueo (*Asio flammeus sandwicensis*) over the Ke-ahole Agricultural Park area. The pueo is found from sea level to at least 8,000 ft. elevation and, unlike most owl species, the pueo is diurnal in habit (Berger 1972). Although the pueo is not classified as an endangered species by the Federal Fish and Wildlife Service, it has recently been so classified by the State Division of Forestry and Wildlife.

The endangered Hawaiian stilt or ae'o (*Himantopus himantopus knudseni*) may occur in the area. It is present in pond areas to the north and south of the project site and may fly over the area.

Indigenous birds -- These are migratory species whose total range in the Pacific Basin area includes the Hawaiian Islands. Walker (1975) observed three migratory shorebirds on the NELH site; these were the golden plover or kolea (*Pluvialis dominica fulva*), the wandering tattler or 'ulili (*Heteroscelus incanus*), and the ruddy turnstone or 'akekeke (*Arenaria interpres*). These shorebirds are seasonal visitors who commonly winter over in the islands.

Introduced birds -- A number of introduced birds were recorded by Walker (1975); these include the Indian gray francolin (*Francolinus pondicerianus*), the barred dove (*Geopelia striata striata*), the common mynah (*Acridothera tristis*), the Japanese white-eye (*Zosterops japonicus*), the house finch (*Carpodacus mexicanus frontalis*), the house sparrow (*Passer domesticus*), the cardinal (*Cardinalis cardinalis*), and the Brazilian cardinal (*Piranga coronata*).

Krauss (1977) also found most of these species present on the agricultural park site in addition to a pheasant species (*Phasianus* sp.).

MAMMALS

Endemic mammals -- The Hawaiian hoary bat (*Lasiurus cinereus semotus*) is the only endemic Hawaiian land mammal. It is found from sea level to 13,200 ft. elevation and is known to occur in Kona (Tomich 1969). The bat probably feeds on insects along the coastal area of the project site during the evenings and night.

Introduced mammals -- The Indian mongoose (*Herpestes auripunctatus*) was the only mammal actually seen during the wildlife survey on the NELH site. However, the presence of other mammals such as the common house mouse (*Mus musculus*), roof rat (*Rattus rattus*), Polynesian rat (*Rattus exulans*), feral cats (*Felis catus*) and goats (*Capra hircus*) was suspected as likely inhabitants of the area.

Krauss (1977) did observe feces and bones of mongoose, mice, and goats in the agricultural park area.

REPTILES AND AMPHIBIANS

There are no native amphibians or land reptiles in the Hawaiian Islands; all species present on the project area are introduced. No frogs or toads are expected to be found in the area (Walker 1975). Nine species of geckos (family Gekkonidae) and skinks (family Scincidae) occur in Hawaii (McKeown 1978) and a few of them probably occur on the project site.

IMPACTS

The proposed project will lead to the loss of habitat on land cleared of vegetation. However, vegetation is sparse and the project area provides only a marginal habitat for birds and other animals.

The proposed project will have no significant impact on the Hawaiian stilt as it prefers the pond areas north and south of the project site; the stilt does fly over the site but will be unaffected by the project.

The Hawaiian owl has a large home range over which it forages for rats and mice; the project will have a minimal effect on its total island population.

The Hawaiian hoary bat is expected to be in the area while feeding in the air along the shore but will not be affected by the project.

REFERENCES

- Berger, A.J. 1972. Hawaiian birdlife. Univ. Press of Hawaii, Honolulu.
- Krauss, B. 1977. Report of flora and fauna survey at Keahole, Kona, Hawaii. Prepared for M & E Pacific, Inc. August 1977.
- McKeown, S. 1978. Hawaiian reptiles and amphibians. Oriental Publishing Co., Honolulu.
- Tomich, P.G. 1969. Mammals in Hawaii. Bernice P. Bishop Museum Spec. Publ. 57, Honolulu.
- Walker, R.L. 1975. Flora and fauna of the Ke-ahole Point Natural Energy Laboratory Site, Island of Hawaii. November 1975.

APPENDIX E

**TRAFFIC ASSESSMENT FOR
FOR NELH/HOST PARK**

**PARSONS BRINCKERHOFF
JUNE 1985**

TRAFFIC ASSESSMENT

This traffic assessment describes the potential traffic impact of the proposed development at Keahole, North Kona, Hawaii, of the Hawaii Ocean Science and Technology (HOST) Park and expansion of the Natural Energy Laboratory of Hawaii (NELH). Peak hour impacts at the Queen Kaahumanu Highway Intersection with the NELH access road and needed improvements are identified. Three development scenarios and conditions for two future years were considered.

Existing Condition

Access to the NELH at Keahole Point is from an at-grade intersection with the Queen Kaahumanu Highway approximately 1.2 miles south (toward Kailua-Kona) of the Keahole Airport Road (Figure 1). Existing traffic volumes on Queen Kaahumanu Highway were obtained from the State Highway Division (1)* (see Table 1); counts indicate good traffic conditions.

Future Condition

As shown in Table 1, traffic volumes on Queen Kaahumanu Highway have shown a steady increase, reflecting development and growth in West Hawaii. Future traffic is expected to continue to increase: for this assessment, 1991 traffic volumes without the proposed development were estimated to be 146 percent of the volumes counted in 1984; 1996 traffic volumes were estimated to be 178% of 1984 volumes.

Proposed Project

The proposed development consists of research and technological activities. Employment projections for the HOST park and the NELH (2) were used to predict 1996 traffic generation. Employment levels for 1991 were estimated for each type of activity. Average rates from the Institute of Transportation Engineers (3) for research centers were used in the computation.

Table 2 shows the computation of project traffic. The project traffic to and from the site was distributed to the north (11%) and south (89%) using the locations of households in West Hawaii (4). Traffic assignments for the morning commute (AM) and afternoon (PM) peak hours and for 1991 and 1996 are shown for each development scenario (Figures 2, 3, and 4).

*() - References listed at end.

Traffic Impacts

The traffic assignments were analyzed for an unsignalized intersection (5) with the following improvements:

- a) acceleration and deceleration lanes to/from the southbound lanes of Queen Kaahumanu Highway.
- b) separate right and left turn lanes from the development (eastbound) to the highway.
- c) a separate left turn lane to separate turning traffic from northbound Queen Kaahumanu Highway traffic.

The analysis results show that an unsignalized intersection would not adequately serve peak hour traffic generated by the proposed development under any of the scenarios. The peak hour traffic expected in 1991 would cause differing conditions under each scenario; the 1991 Scenario A traffic would be adequately served. With Scenario B, 1991 peak hour traffic demands are near capacity; with Scenario C, the unsignalized intersection would not have adequate capacity to serve traffic demands. Table 3 summarizes the analyses of the unsignalized intersection.

Additional turn lanes to serve the high volumes of turning traffic would require signalization for adequate control of the movements. Four intersection layouts, shown in Figure 5, were evaluated using the Planning Analysis of Signalized Intersections (6) of the new Highway Capacity Manual.

Scheme 1 is a signalized intersection with laneage similar to the layout evaluated for the unsignalized case. This layout would be adequate to 1991 for either Scenario A or B. Scenario C demand traffic for 1991 would be near capacity. For 1996 traffic, Scenario A demands would be near capacity and Scenario B and C would have peak hour traffic demands which exceed the intersection's capacity.

Scheme 2 provides a second left turn lane from the highway (northbound) into the NELH access road, which would also be widened. Although this provision improves AM peak period conditions, afternoon conditions are not significantly affected. The adequacy of Scheme 2 would be similar to Scheme 1.

Scheme 3 would widen the access road even more, to allow a double right turn lane onto the highway in a southerly direction. An additional southbound lane would also be needed for approximately 1500 feet to provide for merging. The signalized intersection would operate below capacity for all cases except 1996 Scenario C, in which intersection conditions would be near capacity.

Scheme 4 indicates the improvements which would be necessary to adequately serve Scenario C in 1996. Projected peak hour traffic volumes south of the project would exceed capacities available on a two-lane highway. Widening to four lanes would extend north of the access road in Scheme 4.

Alternative Improvements

An alternative to providing multiple turn lanes at the NELH access road intersection would be to distribute the peak entering and exiting traffic over two or more access points. For example, a connection to the Queen Kaahumanu Highway could be made about 0.5 mile south of the NELH access road to serve the southern portions of the HOST park. Maximum turning volumes at each entrance/exit are expected to be about 60% of those indicated in the assignments if this second connection is provided.

Conclusion

This traffic assessment has estimated future traffic volumes and has identified the potential traffic impacts of the development of the HOST park and the NELH expansion. The intersection improvements needed to provide adequate capacity have also been identified.

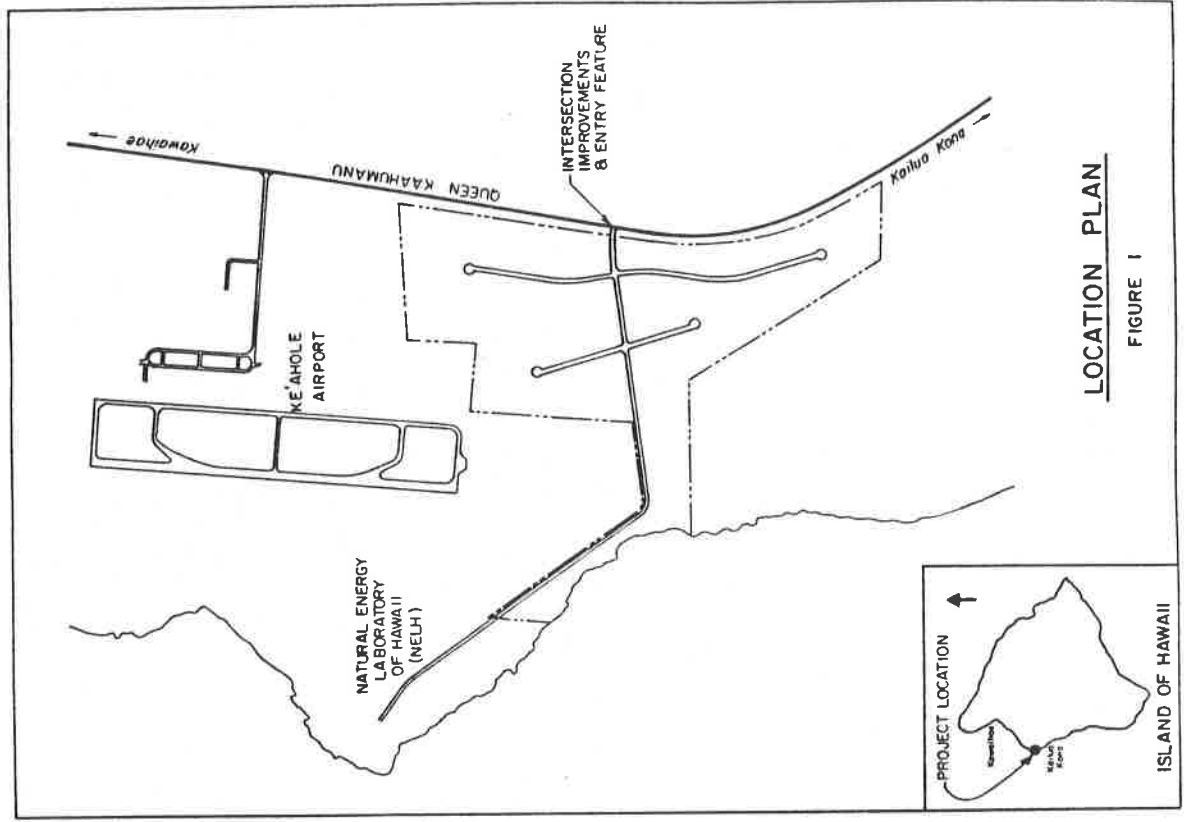

LOCATION PLAN

FIGURE 1

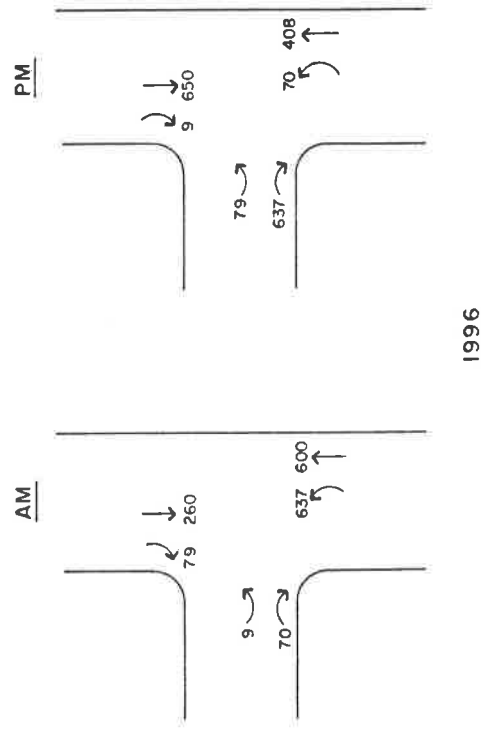
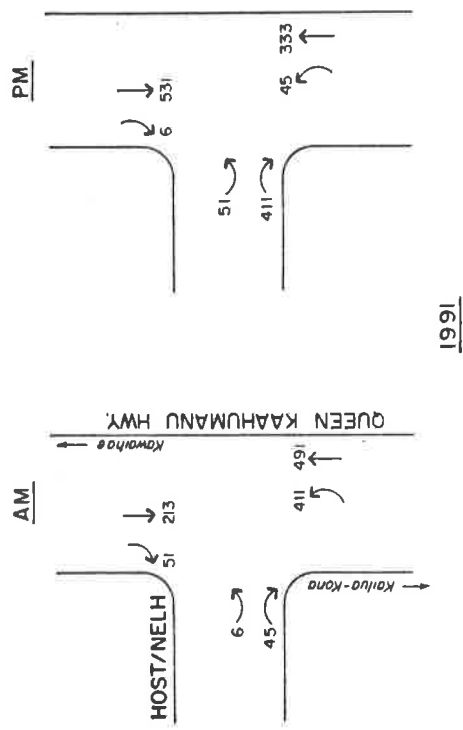
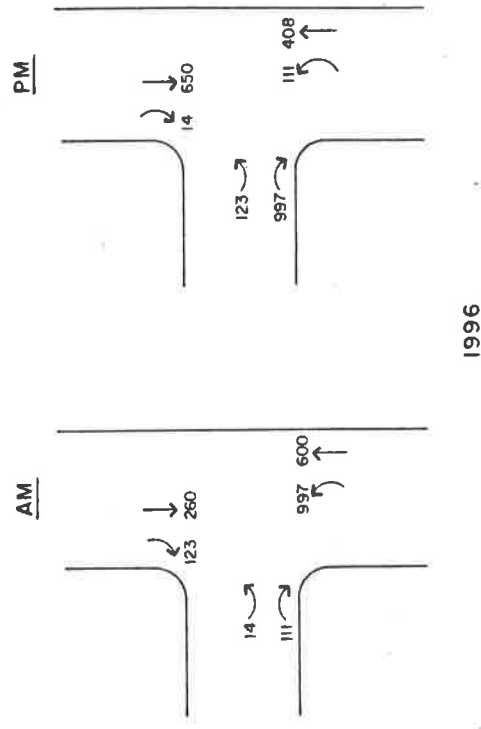
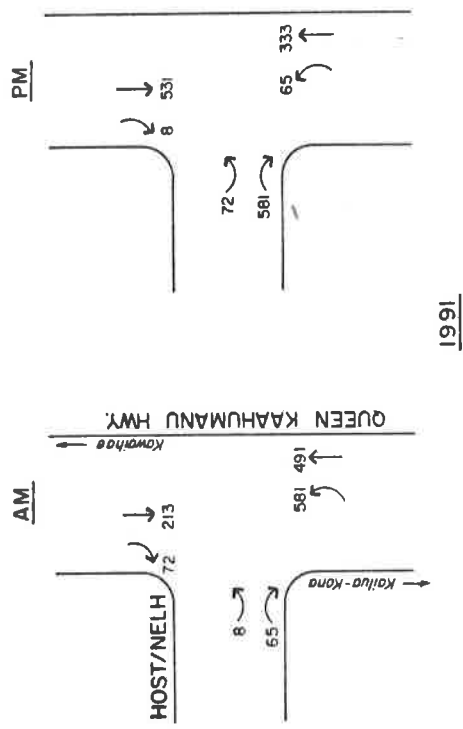

TRAFFIC ASSIGNMENT - SCENARIO A

FIGURE 2

TRAFFIC ASSIGNMENT - SCENARIO B

FIGURE 3

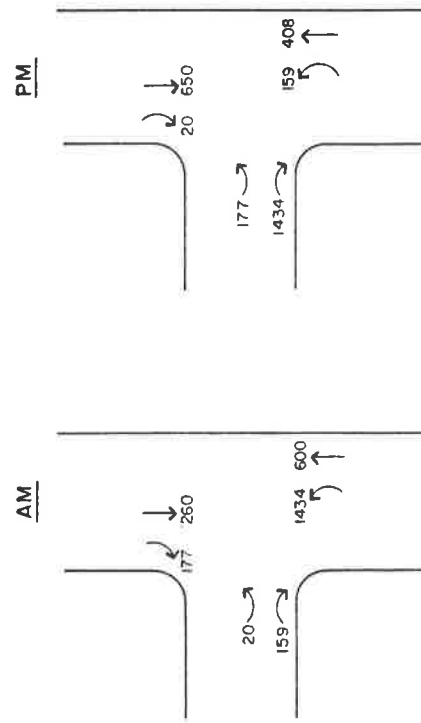
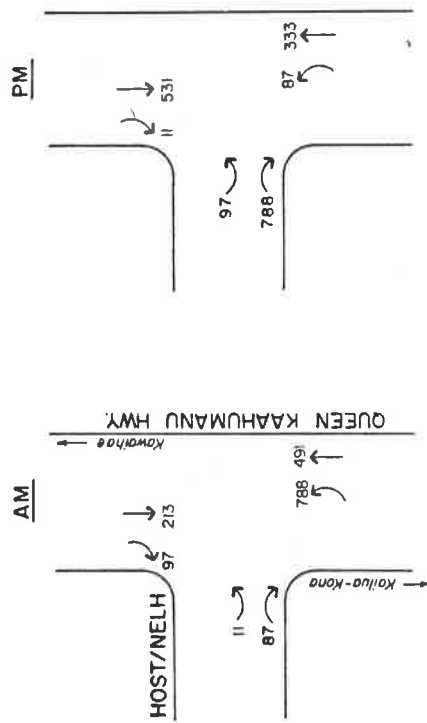

TRAFFIC ASSIGNMENT - SCENARIO C

FIGURE 4

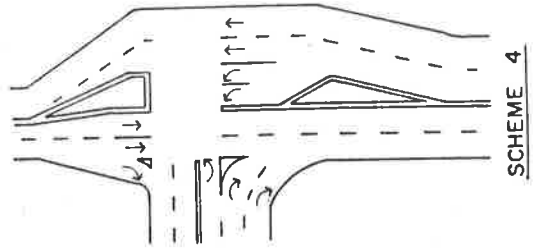
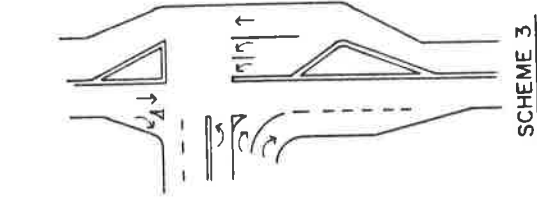
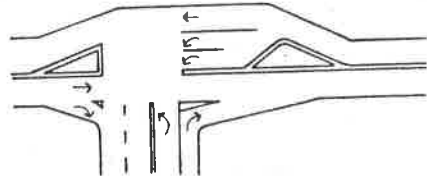
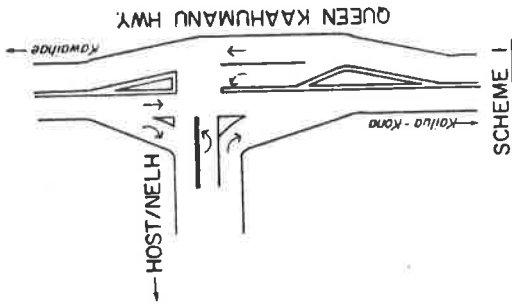

SIGNALIZED INTERSECTION SCHEMATICS

FIGURE 5

Table 1
HIGHWAY TRAFFIC COUNTS
Queen Kaahumanu Highway

	<u>Southbound</u>	<u>Northbound</u>	<u>Total</u>
Daily - 1976	1594	1581	3175
1978	2304	2233	4537
1980	2107	2113	4220
1982	2707	2549	5256
1984	3484	3607	7091
<u>1984 Peak Hours</u>			
6:15 AM - 7:15 AM	146	337	483
10:00 AM - 11:00 AM	225	332	557
3:30 AM - 4:30 PM	365	229	594

Source: State of Hawaii, Department of Transportation, Highways Division. Count Station 8-P (A&B, South of Keahole Airport Road)

Table 2

TRIP GENERATION			
<u>Year</u>	<u>No. of Employees</u>	<u>Daily Traffic¹ In + Out</u>	<u>Peak Hour Traffic² Peak Opposite</u>
Scenario A	1026	2460	462
	1590	3820	716
Scenario B	1451	3480	653
	2490	5980	1120
Scenario C	1966	4720	885
	3580	8590	1611

1 - Vehicles per day, based on 2.4/employee

2 - Vehicles per hour, based on 0.45/employee peak direction and 0.05/employee opposite direction

Table 3
LEVELS OF SERVICE
Unsignalized Intersection*

	1991		1996	
	AM	PM	AM	PM
Scenario A	C	D	F	F
Scenario B	E	E	F	F
Scenario C	F	F	F	F

- *With 1) acceleration/deceleration lanes to/from southbound lanes of Queen Kaahumanu Highway,
2) separate right and left turn lanes from cross street and
3) median left turn lane from northbound lanes of Queen Kaahumanu Highway.

Levels of Service definitions:

- A: Little or no delay
- B: Short traffic delays
- C: Average traffic delays
- D: Long traffic delays
- E: Very long delays; near-capacity conditions
- F: Capacity exceeded by traffic demand

Table 4
INTERSECTION CONDITIONS

	Scenario A		Scenario B		Scenario C	
	1991	1996	1991	1996	1991	1996
Unsignalized	+	-	0	-	-	-
Signalized-Scheme 1	+	0	+	-	0	-
Signalized-Scheme 2	+	0	+	-	0	-
Signalized-Scheme 3	+	+	+	+	+	0
Signalized-Scheme 4	+	+	+	+	+	+

- + = Operates below capacity
- 0 = Operates near capacity
- = Demand exceeds capacity

REFERENCES

1. State of Hawaii, Department of Transportation, Highways Division. Traffic Count station 8-P.
2. Decision Analysts Hawaii, Inc. 1985.
3. Institute of Transportation Engineers, Trip Generation, Third Edition - 1982, Washington, D.C., 1983.
4. State of Hawaii, Department of Planning and Economic Development, The State of Hawaii Data Book 1984, A Statistical Abstract, Honolulu, 1985. Table 13 (pp. 33-34).
5. Transportation Research Board, National Research Council, Circular 281, Proposed Chapters For the 1985 Highway Capacity Manual, 1984.
6. The Traffic Institute, Northwestern University, "Signalized Intersection Capacity Analysis: Planning Techniques of the New Highway Capacity Manual", Evanston, Illinois, 1985.

APPENDIX F

MARINE ENVIRONMENTAL DESCRIPTION
OF NELH/HOST PARK

GK ASSOCIATES
JUNE 1985

HAWAII OCEAN SCIENCE AND TECHNOLOGY (HOST) PARK AND PROPOSED EXPANSION OF THE NATURAL ENERGY LABORATORY OF HAWAII (NELH) AT KEAHOLE, NORTH KONA, HAWAII

MARINE ENVIRONMENTAL DESCRIPTION

1.0 The Existing Site

1.1 Location and Purpose of the Facilities

Keahole has numerous natural resources, among which are high annual insolation, warm surface waters and cold, deep ocean waters of excellent quality and high nutrient content very close to shore. NELH and the proposed HOST park are conceived and designed to develop and implement technologies to beneficially exploit these assets.

The NELH utilizes 320 acres of shoreline property at Keahole Point. Its principal function has been OTEC-related research. The site is fronted by a "research corridor" 1000 feet wide extending 5000 feet offshore. Directly to the southeast are the 547 acres proposed for the HOST park. The principal use for the HOST park is projected to be high-intensity aquaculture, at least in the lower elevations nearer the shoreline.

1.2 Geology, Hydrology and Bathymetry

The geology is characterized as that of low dipping flank flows of primitive basalt. The dips slope less than five degrees. Individual flow units are small, not larger than several hundred feet wide and 100 feet thick. The average thickness of a flow unit is 10 feet. Lava tubes are common, but intrusive forms such as dikes are absent. The vertical is highly permeable. Because the basalts in the area are highly fractured, vertical barriers to groundwater movement are small, and in some localized areas, water may be transmitted vertically more readily than horizontally (Dames and Moore, 1985).

The shoreline varies from level beaches to cliffs of up to 15 feet which contain caves and lava tubes extending mauka. Water depths reach 2500 feet within a mile of the shoreline. Between 500 and 2500 feet deep, the bottom slope is approximately 30 degrees. Above this, the slope angle decreases. Sand channels up to 30 feet wide separate basalt outcrops perpendicular to the shoreline.

1.3 Physical Oceanography

Currents offshore Keahole Point are dominated by two processes. Tidal oscillations drive reversing currents with diurnal and semi-diurnal periods. Typical maximal tidal current speeds are 3/4 to 1 knot. Tidal currents may, however, be obscured for extended time periods by large-scale eddies propagated from the Alenuihea Channel. Noda (unpub. data) documented a persistent northward eddy flow of about 1.5 knots for about five days.

Bathen (1975) found offshore surface currents ranging in speed from 10-37 cm/sec, or, on average, less than half a knot. Deep currents have been measured in the range 1-10 cm/sec (Bretschneider, 1978).

Wave heights rarely exceed 7 feet, except under certain storm conditions. The highest recorded wave in this area in the past 20 years was 25.5 feet. Variations in water chemistry have led to hypotheses of very large internal waves moving in the pycnocline.

1.4 Water Quality

1.4.1 Classification and Standards

Coastal waters off Keahole are Class AA. Groundwater seepage along this coast is reported to exceed 6 mgd per mile (Dames and Moore, 1985). Although this water is brackish, this volume of influx is double the break point between wet and dry coastal areas and the wet criteria should apply. In any event, the data collected from the NELH warm water intake indicate that the water quality standards are being met. Several studies (WRRC, 1980; R.M. Towill, 1981) have reported that coastal water quality standards are exceeded near the shore. It would not be unexpected to find nutrient concentrations elevated as a consequence of a high proportion of groundwater in very nearshore samples. Discharges into Class AA waters are prohibited. Waters deeper than 100 fathoms are Class A which may receive discharges. The reef communities are Class I. The water quality standards for this area are summarized in Table 1.

1.4.2 Ambient Quality

1.4.2.1 Radiant Energy and the Photic Zone

Noda, et al. (1980) measured scalar (nondirectional) irradiance in the photosynthetically active wavelengths (400-700 nm) through the water column at the HOSTEC site. Extinction coefficients ranged between 0.027 and 0.033 per meter, typical of low latitude open ocean waters of high clarity. The photic zone extended to about 125 meters.

1.4.2.2 Physicochemical Parameters

1.4.2.2.1 Temperature and the Thermocline

Sea surface temperatures in Hawaii vary relatively little annually or diurnally. Gundersen (1974) reports the range as 23-28.5 degrees C. The wind-mixed surface layer extended 50 to 100 meters deep. The bottom of the thermocline, where temperatures average 12-13 degrees C, may extend to 150 meters (OOME, 1981).

1.4.2.2.2 Salinity, Density and the Pycnocline

Noda, et al. (1980) summarize the results of six cruises designed to provide baseline data at the OTEC-1 site. The salinity results are typical. From the surface to about 70 meters deep the salinity was uniform in the range 34.227-34.774 ppt. Below this was a subsurface layer of maximal salinity (34.575-35.173) centered between about 100-125 meters. A salinity minimum (34.003-34.340) occurred at about 275 meters, and slightly higher values were recorded from below. These variations in salinity represent, at the surface, land mass effects, and below, water masses common throughout the Pacific Ocean.

Table 1. State of Hawaii:
Water Quality Standards

Specific Criteria for Open Coastal Water, Class AA

("Open Coastal Waters" are marine waters bounded by the 100 fathom (183 meters or 600 feet) depth contour and the shoreline, excluding embayments. Criteria differ based on fresh water discharge)

Parameter	Geometric mean not to exceed the given value	Not to Exceed the given value more than 10% of the time	Not to exceed the given value
Total Kjeldahl Nitrogen (ug N/l)	150.00* 110.00**	250.00* 180.00**	350.00* 250.00**
Ammonia Nitrogen (ug NH ₄ -N/l)	3.50* 2.00**	8.50* 5.00**	15.00* 9.00**
Nitrate + Nitrite Nitrogen (ug (NO ₃ + NO ₂)-N/l)	5.00* 3.50**	14.00* 10.00**	25.00* 20.00**
Orthophosphate Phosphorus (ug PO ₄ -P/l)	7.00* 5.00**	12.00* 9.00**	17.00* 13.00**
Total Phosphorus (ug P/l)	20.00* 16.00**	40.00* 30.00**	60.00* 45.00**
Light Extinction Coefficient (k units)	0.20* 0.10**	0.50* 0.30**	0.85* 1.55**
Chlorophyll a (ug/l)	0.30* 0.15**	0.90* 0.50**	1.75* 1.00**
Turbidity (Nephelometric Turbidity Units)	0.50* 0.20**	1.25* 0.50**	2.00* 1.00**
Nonfilterable Residue (ug/l)	20,000.00* 10,000.00**	30,000.00* 15,000.00**	40,000.00* 20,000.00**

**Wet" criteria apply when the open coastal waters receive more than three million gallons per day of fresh water discharge per shoreline mile.

**Dry" criteria apply when the open coastal waters receive less than three million gallons per day of fresh water discharge per shoreline mile.

Applicable to both "wet" and "dry" conditions.

pH Units shall not deviate more than 0.5 units from a value of 3.1.

Dissolved Oxygen - Not less than 75% saturation.

Temperature - Shall not vary more than 1°C from ambient conditions.

Salinity (ppt) - Shall not vary more than 10% from natural or seasonal changes considering hydrologic input and oceanographic factors.

Walsh (1985) reports the results of water chemistry analyses on samples collected offshore of the NELH facility. Salinity always increased with depth in nearshore waters. Offshore, there was a peak concentration at 30-150 meters with low surface values and even lower concentrations at 150-200 meters. These results are consistent with HOTEK data. In general the salinity values are highly variable spatially and temporally, indicating large scale, rapid water mass mixing or movement. Transects offshore were quite variable from day-to-day and the lowest values were not always found inshore.

1.4.2.2.3 pH

In the ocean, pH is maximal at the surface due to the combined effect of carbon dioxide uptake and oxygen evolution in the photosynthetic process. With depth, decomposition and respiration increase, consuming oxygen and depressing pH. A pH minimum generally coincides with the oxygen minimum. Gordon (1970), at an oceanic station north of Oahu, found a surface pH of 8.27, and a minimum of 7.75 at 500-600 meters. NELH intake monitoring values were quite similar (Table 2).

1.4.2.2.4 Dissolved Oxygen

Noda, et al. (1980) reported a mixed layer extending to about 90 meters in which oxygen concentrations ranged between 4.8 and 6.3 ml/l. Surface layer concentrations were at or above saturation values. A broad oxygen minima (1.0 ml/l) occurred between 450 and 900 meters.

Walsh's (1985) dissolved oxygen values were highly variable. The deepest samples (200 m) all showed about 4.4 ml/l, consistent with the HOTEK data. Most of his samples were from near-surface waters and concentrations were well above saturation.

1.4.2.3 Macro-Nutrients

Noda, et al. (1980) found three distinct nutrient layers in their offshore depth profiles. In the mixed layer, concentrations were low and uniform, the result of uptake by phytoplankton. In the aphotic waters between about 150 and 400 meters there was a rapid increase in nutrient values caused by dissolution of particulate material from above and vertical diffusion. Maximal values were found below 600 meters.

Walsh (1985) found that, in general, inshore nutrient concentrations were low, but consistently higher than in offshore waters. Offshore transects showed that nearshore salinities were lowest, nutrients were highest, clearly reflecting shoreline seepage of nutrient-rich, brackish basal water.

1.4.3 Groundwater Intrusion

Underlying the Keahole coast is a thin, unconfined basal groundwater lens, brackish in salinity. Aerial infrared images indicate considerable groundwater seepage at the shoreline (Fischer, et al., 1966). Nearshore well waters have a chloride content greater than 1000 ppm (DLNR, 1970), more than four times the U. S. Public Health Service standard for drinking water. The chloride concentration at the top of the water table decreases inland, where lighter, "fresh" groundwater floats above denser, brackish waters.

Table 3. Water Quality Data
NELH Discharge Sites
(Weekly samples, 1983)

Parameter	Unit	Site		
		Site 1	Site 2	Site 3
Temperature	°C	16.90	18.56	20.050
Salinity	‰	34.201	33.496	33.735
pH	---	7.884	---	---
NO ₃ + NO ₂	ug-at/l	26.78	20.70	15.66
NH ₄	ug-at/l	1.57	1.42	1.50
PO ₄	ug-at/l	2.20	1.92	1.67
Silicon	ug-at/l	52.12	47.70	42.93
Diss. Org. nitrogen	ug-at/l	2.64	3.75	5.20
Diss. Org. phosphorus	ug-at/l	0.11	0.18	0.24
Total Org. carbon	mg C/l	0.79	---	---

Table 2. Water Quality Data
NELH Warm and Cold Seawater Systems
(Weekly samples, 1982-83)

Parameter	Unit	Warm Seawater System			Cold Seawater System			Ratio - warm: cold water
		Max	Min	Mean	Max	Min	Mean	
Temperature	°C	28.00	24.30	---	20.70	8.20	---	---
(in Lab)	°F	82.40	75.70	---	51.30	8.20	---	---
Salinity	‰	35.05	34.33	34.71	34.37	34.21	34.29	---
pH	---	8.35	8.02	8.24	7.64	7.45	7.55	---
NO ₃ + NO ₂	ug-at/l*	0.50	0.05	0.17	41.70	38.80	39.62	1:230
NH ₄	ug-at/l	0.76	0.20	0.47	0.76	0.06	0.34	---
PO ₄	ug-at/l	0.34	0.03	0.15	3.17	2.69	3.00	1:20
Silicon	ug-at/l	11.52	1.80	3.46	84.96	69.13	77.58	1:22
Total diss. nitrogen	ug-at/l	7.84	2.51	4.12	48.00	37.32	42.16	1:10
Total diss. phosphorus	ug-at/l	0.66	0.19	0.35	3.26	2.72	3.03	1:9
Total org. carbon	mg C/l	1.20	0.51	0.91	0.99	0.07	0.58	---

* microgram -- atoms/litre

The groundwater discharges are generally diffused, but there is a shoreline spring near Wawali Beach visible at low tide (Dames and Moore, 1985).

1.4.4 Runoff

There are no perennial streams in the area, and overland flows are insignificant except as a result of severe storms when gulches may have temporarily high discharges.

1.4.5 Existing Point Sources

OTEC seawater from NELH is disposed of into a canal approximately 60 meters long and 15 meters wide. The canal surface is rough, recent lava with a maximum depth of less than 20 cm.

Walsh (1984) summarizes data collected in a weekly water quality monitoring program at NELH. Samples were collected from the surface seawater intake, the deep seawater intake, the mouth of the discharge pipe (site 1), and at sites in man-made tidepools 15 and 25 meters downstream (sites 2 and 3, respectively). The total discharge at the time of the most recent samplings reported was about 1000 gpm, of which about sixty percent was surface water. The values reported here are from the 1983 surveys. Salinity values were very slightly depressed from what would be expected, reflecting an unidentified low volume freshwater component of the discharge. The mean values for surface and deep samples are very similar to those recorded in the surveys reported in above sections. Brewer, et al. (1985) summarize the results of the weekly water quality monitoring program at the NELH in Table 2. Table 3 summarizes the mean values at the discharge monitoring sites.

The seawater discharge from the abalone aquaculture facility are also disposed of behind the shoreline, but discharge volumes and chemical quality data are not available. Aquaculture production facilities producing less than 100,000 pounds of product are exempt from the NPDES permit and its monitoring requirements.

Domestic sewage from NELH is disposed of into cesspools.

1.5 Biota

1.5.1 Anchialine Ponds

Anchialine ponds are shoreline pools without surface connection to the sea, having waters of measurable salinity and showing tidal rhythms (Holthuis, 1973). Anchialine ponds occur close to the shore where a basaltic surface collapses and the top of the water table is exposed. They are found no farther inshore than about one half kilometer. They are known from Hawaii, southwest Maui and other parts of the world. Geologically, they are temporary features, subject to inundation by lava or filling by wind-blown sediments or organic detritus produced in the pond. Anchialine ecosystems are characterized by low species diversity, but distinctiveness in species present.

Maciolek and Brock (1974) surveyed 305 anchialine ponds along the Kona coast. Three anchialine ponds occur in the NELH area. One is small (less than 10 m²) and two are intermediate in size (10-100 m²). They are all shallow, with salinities of about 7-8 ppt. Bottoms are a mixture of rock and sediment. Two have no bordering vegetation;

one has trees, shrubs and emergent vines and succulents. Biota in these ponds includes benthic algae, worms, mollusks and crustaceans. Among the latter are *Halocarcinus rubra*, a small endemic red shrimp. One of the ponds has a population of *Macrobrachium grandimanus*, an endemic prawn more common to Hawaiian streams. No fish were observed in these ponds. According to the ranking of Maciolek and Brock (1974), they are not of high natural value.

Six anchialine ponds occur in the HOST area. All are small (less than 10 m²) and shallow, with salinities in the range 4-6 ppt. Bottoms show little if any sedimentation. Trees and grasses border the ponds. The biota of the HOST ponds is significantly different from that of the NELH ponds in that the former include no benthic algae. The fauna consists of two species of snails and the two endemic red shrimp, *H. rubra* and *Metabetaeus lohena*. None of the ponds are classified as having high natural value.

The nearest ponds of exceptional value (Maciolek and Brock, 1974) are the 29 Kahanaiki Ponds located near Wawahiwa Point, 2.25 miles south of Keahole and about one mile southwest of the southern limit of the park. These are shallow to medium-deep ponds, most of small size, but some larger than 100 m² in surface area. Salinities in these ponds range from 9-13 ppt. Bottom types vary from rock to sediment covered, and surrounding vegetation includes trees, grasses and vines.

1.5.2 Water Column Communities

1.5.2.1 Phytoplankton and Photosynthesis

The clear, oligotrophic surface waters around Hawaii are low in dissolved plant nutrients and support a low standing crop of phytoplankton. Phytoplankton biomass is typically measured as the concentration of chlorophyll a, either per cubic meter at a given depth, or per square meter of sea surface for a given depth range.

Noda, et al. (1980) report the results of chlorophyll a profiles at the HOTEK site. They found a shallow mixed layer about 60 meters deep which had low concentrations (0.03-0.18 mg/m³, mean 0.11 mg/m³). This surface layer graded into a region between 64-94 meters where a deep maximum occurred (0.17-0.62 mg/m³, mean 0.31 mg/m³). The authors attribute this maxima to decelerated sinking rates in the increasingly dense subsurface waters, and to increasing intracellular chlorophyll concentrations through adaptation to reduced light intensities. Below this, chlorophyll a declined with depth to insignificant levels below 200 meters. Integration of values to show concentrations per square meter of sea surface yielded the following results. The mean value in the upper 260 meters was 24.55 mg/m², of which 12-30 percent was found in the upper 60 meters. The mean value in the mixed layer was 5.33 mg/m².

Phaeopigment (a chlorophyll degradation product) concentrations were also determined by Noda, et al. (1980). On average, the phaeopigment concentrations were 55 percent of the chlorophyll concentrations. Depth profiles were similar in shape to those of chlorophyll. There was a shallow, surface layer of low concentrations, a subsurface maximum at or below the chlorophyll maximum and declining deep concentrations.

Primary productivity at the HOTEK site was measured using the carbon-14 uptake method and in situ incubation. Depth variability was slight, and biomass correlations were absent. Inhibition of photosynthesis by bright, surface sunlight was not detected,

nor was a subsurface maximum in productivity. The rate of production per unit biomass rapidly decreased with depth. Nutrient limitation was evident at the surface, while decreasing light limited productivity in deeper waters. Depth integrated production varied enormously over the six cruises (0.72-18.70 mg C/m²/hr, mean 8.79 mg C/m²/hr). Average daily primary production was 0.015 g C/m²/day, or 38.4 g C/m²/year. On three of the six cruises, values neared the lower limits of detection for the analytical method.

Ancillary to the HOTEK cruises, a series of enrichment experiments were performed. Surface water was spiked with deep (600 m) water. Growth responses varied from no effect to 300 percent increases and seemed to depend on the physiological preconditioning of the resident phytoplankton population.

1.5.2.2 Zooplankton

Zooplankton biomass was measured on the HOTEK cruises. The mean concentration in the upper 25 meters was 3.04 mg/m³, and that for the 25-200 meter layer was 3.32 mg/m³. Overall, there is an approximate fifty percent increase in nighttime concentrations in the upper 200 meters. However, this increase is due to much larger increases in the upper 25 meters. In the 25-200 meter range, nighttime concentrations actually decline.

Taxonomically, samples showed that the calanoid copepods were most abundant. Macrozooplankton in Hawaiian waters are generally characterized as having high diversity, but low abundance.

1.5.2.3 Larval Fish

The most abundant fish larvae in the HOTEK samples (Nods, et al., 1980) were Myctophidae, midwater lantern fish. They are of no direct economic importance, but may be, because of their large numbers, important components of midwater food chains.

Sands (1979) cites unpublished data of Leis which indicate that at three kilometers offshore of Keahole the density of fish larvae is 371/1000 m³, and that 84 percent are inshore forms.

Lobel and Robinson (1984) found that cyclonic eddy current systems may function as offshore larval nursery grounds. They tracked an eddy system which remained off Kona for at least 58 days coinciding with the end of the peak spawning season for Hawaiian fishes. The outer swirls of the eddy system were observed to sweep up and over inshore reef edges.

1.5.2.3 Larval Fish and Other Micronekton

1.5.2.4 Fish

1.5.2.4.1 Shallow-water Surveys

The Keahole Point region harbors one of the most diverse and abundant reef fish assemblages in the populated Hawaiian Islands. ORCA (1977) and ORCA (1978)

provide detailed descriptions of the reef fish populations for a range of depths, locations, and seasons. These surveys recorded at least 120 reef fish species. There is a distinctive zonation of species composition according to depth. Generally, the abundance of adult fish decreases with depth offshore of the Keahole Point region.

The surge zone (nearshore to -20 feet) supports the largest fish biomass which is probably associated with the presence of lush growths of seaweed. The depth zone from -40 to -60 feet shelters a large number of fish species that are relatively uncommon in Hawaii. Dense beds of the finger coral, Porites compressa, at depths from 50 to 100 feet serve as an important nursery area for juvenile reef fish.

Fish species which are conspicuous in diving surveys include some important market species (the omilu, Caranx melampygus; the 'oio, Albula vulpes; the weke 'uia, Mullidichthys vanicolensis), some important subsistence species (the kole, Ctenochaetus strigosus; the nenu, Kyphosus sp.), and species of damselfishes, butterflyfishes, and juvenile forms of surgeonfishes which are collected for the commercial aquarium fish trade.

The following sectional descriptions of the shallow-water fish fauna are from Nolan and Cheney (1981):

Unualoha Point - Keahole Point

The most frequently encountered species in the middle reef terrace (-20 feet) include the yellow tang, Zebrasoma flavescens, the chevron tang, Acanthurus nigrostriatus, the kole, Ctenochaetus strigosus (an important subsistence species), and the mamo, Abudefduf abdominalis. These species plus the olive damselfish, Chromis vanderbilii, are also conspicuous in the lower reef terrace (-30 feet). The whitetailed damselfish, Chromis aqilis, and the kole are common species at a depth of -50 feet. The deeper reef slope (-90 feet) harbors the blue damselfish, Chromis ocellis, and the black damselfish, C. verater.

Keahole Point - Wawaloli Beach

Large, roving predators like the omilu, Caranx melampygus, (an important market species) and the nenu, Kyphosus cinerascens (an important subsistence species) frequent the surge zone. Other characteristic species include the mustard tang, Acanthurus guttatus, the achilles tang, A. achilles, the humuhumu nukumukuapua'a, Rhinecanthus rectangulus, the mamo, and the stickfish, Aulostoma chinensis.

At least 55 fish species inhabit the middle reef terrace (-20 to -50 feet), the most predominant being the olive damselfish. Also common are the kole, the yellow tang, and the hinalaea lauwiili, Thalassoma dubreuyi.

At least 51 fish species have been recorded on the lower terrace (-40 to -60 feet) in spite of a low density of live coral in this depth zone. In addition to the species which are common on the middle terrace is the lavender tang, Acanthurus nigrofuscus.

At least 43 species occur in the transition zone from terrace to offshore slope (-50 to -60 feet). The predominance of juvenile fishes in this zone coincides with the habitat provided by lush colonies of the finger coral, P. compressa. The most frequently

observed species are the yellow tang, the kole, the olive damselfish, the whitetailed damselfish, and the pebbled butterflyfish, Chaetodon multicinctus.

The upper portion of the offshore slope (-60 to -100 feet) supports at least 37 species, the most abundant of which are the whitetailed damselfish, the damselfish, Chromis hanuui, the blue damselfish, the yellow tang, the kole, and the pebbled butterflyfish.

Manta rays (Mobula japonica) and the 'oio, Albula vulpes, an important food fish, occasionally are observed in this depth zone. The rare butterfly fish, Cheetodon linkeri, is occasionally sighted, but the abundance of this species has been greatly reduced by aquarium fish collecting.

Important market species, including the weke 'uia (Mulloidichthys vanicolensis), the omilu (Caranx melampygus), the uku (Aprion virescens), and the awa awa (Chanos chanos) have also been sighted during diving surveys off Keahole (ORCA, 1977; ORCA, 1978).

Wawaloii Beach - Wawahiwa'a Point

A very abundant and diverse fish fauna has been surveyed by Nolan (1978) in the vicinity of Wawahiwa'a Point. Over 53 species occur in this area. Most abundant are the whitetailed damselfish, the himalea lauuli, the yellow tang, the kole, the butterflyfish Hemitaenichthys zoster (= H. polylepis) (at depths exceeding 60 feet), the weke 'uia Mulloidichthys vanicolensis, the opelu Decapterus macarellus, and the mamo (in the shallows). Manta rays and 'oio are frequently observed offshore, and the skipjack tuna Katsuwonus pelamis are also observed near shore. Dense beds of the finger coral, P. compressa, provide important habitat for juvenile fishes.

1.5.2.4.2 Deep-water Surveys

The fish populations of the deep slopes and terraces offshore of the Keahole region have been observed during deepwater submersible surveys. The fish fauna appears to be quite diverse and abundant along the steep boulder-strewn slope extending from -150 to -250 feet. Most conspicuous are surgeonfishes, especially the kole, but the assemblage includes the ta'ape, Lutjanus kasmira, butterflyfishes (the longnose Forcipiger sp., the lemon butterflyfish Chaetodon miliaris, and the false moorish idol Heterochus dipreutes), and various parrotfishes. Over sandy patches interspersed between boulders are seen kumu (Parupeneus porphyreus) or a kumu-like species of goatfish.

From -250 to -300 feet, the angle of bottom slope decreases and the bottom is littered with lava rock rubble. Enormous aggregations of ta'ape have been observed in this zone, and surgeonfishes (probably the deepsea or opelu kala, Naso sp.) are also common. Rock crevices harbor squirrelfishes and occasional moray eels.

At a depth of -300 feet, there is an abrupt transition from a rocky slope to a sandy terrace, where vast populations of ta'ape were observed foraging. The next major change in the bottom occurs at about -500 feet, where the sandy plain rolls off to a steep rocky slope which supports moderate fish populations, mostly squirrelfishes and

anthines, with an occasional snapper, Symphysanodon typus. Anthines inhabit occasional rocky ledges at depths below -500 Feet (Harrison, 1985).

1.5.2.4.3 Commercial Fish Catches

Commercial fish catch statistics compiled by the Hawaii Department of Land and Natural Resources (HDLNR, 1980) show that the inshore (shoreline to 2 miles offshore) and offshore (2 miles to 20 miles offshore) waters fronting the Kona coast are the most productive in the populated Hawaiian Islands. Yellowfin tuna (ahi), blue marlin, opelu, and ono account for the greatest catch weight. Kona is also the site of the largest charterboat fishery in the State and is the focal point of big-game fishing tournaments (HDLNR, 1980).

The Keahole area is one of the traditional Kona fishing grounds for yellowfin tuna (ahi) and skipjack tuna (aku). Commercial fishing and charterboats commonly frequent the offshore waters. A limited amount of bottomfishing also occurs offshore.

The Keahole region is one of the most important areas in the State for aquarium fish collecting (Nolan, 1978). The State of Hawaii requires aquarium fish collectors to be licensed and file catch reports. The catch data are collected for large statistical areas which combine the Keahole Point region with other areas. The data indicate that since fiscal year 1981-82, nearshore areas north of Keahole Point to Maiea Point have become more significant in terms of the relative contribution to the statewide catch, whereas nearshore areas south of Keahole Point to Hoopuloa have become relatively less significant in terms of the total statewide catch. In FY 1983-84, the areas from Keahole Point north produced about 16% of the statewide catch of aquarium fish, compared to only 4% in FY 1981-82. The areas from Keahole Point south produced about 3% of the statewide aquarium fish catch in FY 1983-84, compared to 6% in FY 1981-82 (State Div. Aquatic Resource, statistical catch summaries).

1.5.2.5 Marine Mammals

The Marine Mammal Protection Act, in the broadest sense, prohibits the "taking" of all marine mammals. "Taking" is extremely broadly interpreted to include "harassment" or acts which unintentionally affect the natural behavior of marine mammals.

Shallenberger (1979) thoroughly reviews the status of marine mammals in Hawaiian waters. Nineteen species are at least occasionally sighted, but little information exists on species other than the humpback whale and spinner dolphin. Most species of whales are much more frequently sighted in the Northwestern Hawaiian Islands than around the main Hawaiian Islands.

A number of species of dolphins occur in Hawaiian waters. The bottlenose dolphin (Tursiops gilli) occupies a wide variety of habitats around the islands including estuaries, inshore and offshore waters. Individuals grow to a size of four meters and more. The Spotted dolphin (Stenella attenuata) is very common in Hawaii, and may be the most abundant Hawaiian cetacean. It is found in large herds throughout the islands, nearly always at least three kilometers from shore. The spinner dolphin (Stenella longirostris) is also found throughout the Hawaiian chain. The Hawaiian

population has behavioral and morphological differences from populations in the eastern tropical Pacific. Schools tend to remain in well-defined home ranges. The dolphins eat primarily mesopelagic fish and epipelagic or mesopelagic squid. The Rough-toothed dolphin (*Steno bredanensis*) is common in Hawaiian waters, but is rarely seen because it favors waters more than 900 meters deep.

1.5.2.6 Endangered and Threatened Species

The Endangered Species Act prohibits "attempts" to harass, pursue, hunt, etc. listed species. The ESA also prohibits significant environmental modification or degradation to the habitat used by, and acts which result in, the significant disruption to natural behavior patterns of threatened and endangered species.

Species of concern in the Keahole region include the endangered humpback whale (*Megaptera novaeangliae*) and the threatened green turtle (*Chelonia mydas*).

The humpback whale is one of the most depleted species of marine mammals in the world, with a total population estimated at 4000-5000 whales (USDC, 1983). There has been no commercial harvest of this species since 1966, and it has been listed as endangered in the U.S. since 1970. Adults may grow to exceed 13 meters in length and weigh up to 40 tons. Reproductive maturity is reached in five to six years at a size of 11-12 meters. Life spans may reach 70 years. The reproductive cycle generally spans two years. The whales mate on their summer, high-latitude feeding grounds. After an 11-month gestation period, a single 4.5-5 meter calf is born. Weaning takes place after about six to eight months, prior to the southward winter migration. Natural mortality rates are unknown. The literature suggests that the humpback seldom feeds while on its wintering grounds in Hawaii.

The Hawaiian population of humpbacks is the largest of the three Pacific populations, numbering 600-800. The whales usually first appear in Hawaiian waters in November, peak in abundance in mid-February, and are scarce by mid-May. Humpbacks enter the main Hawaiian Islands from the north or northwest, with the waters of Maui County a primary destination. Shallenberger (1979) identifies the areas of primary importance as Penguin Bank and the waters between Maui, Molokai, Lanai and Kahoolawe. Calves are most abundant in Maalea Bay and off Kaena Point, Lanai. Areas of secondary importance he identifies as Kaula, Niihau, the south Kauai coast and the northwest coast of Hawaii. The humpback whale management plan (USDC, 1983) adds the north and east coasts of Oahu and the bank extending off Ka Lae (South Point), Hawaii.

The threatened green turtle is the only turtle species which lives and breeds in Hawaii. The hawksbill and leatherback turtles also occur in Hawaiian waters and are designated endangered. The Pacific ridley turtle is also occasionally sighted in these waters (Balazs, 1980). More than ninety percent of all breeding by Hawaiian green turtles occurs at French Frigate Shoals, and most other nesting sites are also in the Northwestern Hawaiian Islands. The annual production of hatchlings for the Hawaiian archipelago has been estimated to be 26,500. Nesting occurs most commonly in June and hatching takes place in August. Green turtles have been found to feed on 35 species of benthic algae, one marine angiosperm and nine types of invertebrates.

The nearest important resident area of green turtles to the Keahole region is at the northwestern tip of Hawaii. Another important area is found along the southeast coast at Kau.

1.5.3 Bottom Communities

Dollar (1977) summarizes the environmental factors responsible for the composition and density of coral cover along the Kona coast. He cites five major variables: wave energy, light, sedimentation, available substrata, and interspecific competition. The dominant coral species are *Porites compressa* and *P. lobata*. These two species represent almost 96 percent of the coral cover, and over 80 percent of total bottom cover in the areas he surveyed. *P. compressa* has a distinct competitive advantage due to its rapidly spreading branching structure which tends to exclude other colonies from developing in its shadow. On the other hand, its branches are relatively fragile, and where wave action is heavy, more massive species dominate. *P. compressa* decreases in relative abundance southward along the Kona coast due to increasing wave action. Where *P. compressa* does not dominate, *P. lobata*, a generalist species having a variety of growth forms, tends to fill in, although where this occurs, coral diversity increases because the dominance of *P. lobata* is not as restricting as that of *P. compressa*. In areas of strong water movement, where the existing coral cover may be periodically destroyed, *Pocillopora meandrina* may be the first colonizer, but later be outcompeted by other species.

1.5.3.1 Surge Zone

Brook and Brock (1974) surveyed the entire western coast of the Big Island to depths of thirty feet offshore. In their survey they identified 163 species of invertebrates and 137 species of fish. They noted three principal habitats in this depth range: tidepools, subtidal waters affected by freshwater input, and truly marine subtidal waters. The waters affected by groundwater represent a habitat unique in Hawaii which supports a discrete fish and invertebrate assemblage.

The following information is drawn primarily from the West Hawaii Coral Reef Inventory (Nolan and Cheney, 1981). The shoreline in the project area consists typically of vertical cliffs five to twenty feet high, fronted by a smooth, irregular basalt pavement densely covered with large (three to six feet diameter) basalt boulders. Tide pools are common. Offshore vertical relief ranges from about four to twenty feet. The wave-washed bench is subject to severe wave activity, particularly fronting Keahole Point. Coral diversity is low in the high surge zone; *Pocillopora meandrina* is the most abundant species, but coral coverage is less than five percent. Individual colonies are small in size, rarely larger than six inches across. Encrusting coralline algae are common in this zone, but generally benthic flora and fauna are sparse.

1.5.3.2 Nearshore Terrace

The nearshore terrace along this coastal segment varies from about 200 to about 400 feet wide at depths of -15 to -60 feet. The size and concentration of basalt boulders decreases with depth. Coral diversity and cover are high in this zone, with cover to forty percent noted in Nolan and Cheney (1981). *Porites lobata* is the dominant coral. Individual colonies reach three feet in width. Encrusting algae and sea urchins (especially *Echinothrix diadema* and *Tripneustes gratilla*) are very common.

1.5.3.3 Nearshore Slope

Inshore portions of the slope are described by Nolan and Cheney (1981). The substratum consists of unconsolidated limestone rubble, basalt boulders one to three feet in diameter, coarse sand and rock outcrops. Coral cover is dense, reaching almost 26 percent. The dominant species is *P. compressa*.

Harrison (1985) describes observations made from the submersible Makali'i between 60 and 200 meters deep offshore of Ke-ahole Point. He describes three distinct zones in the pipeline corridor. These zones are characterized by predominantly different substrata types, slopes, ambient light and to some extent nutrient regimes, and display consequent biological differences.

The nearshore slope extends offshore in water depths from about 45 to 80 meters. The substratum consists of lava boulders and rubble with patches of primarily biogenic, mid-sized (0.25-1 mm) calcareous sediment having very little organic content. The slope is fairly steep, averaging about 40 degrees. Most of the hard surfaces are barren and show a light cover of sediment. Fleishy seaweed algal beds are conspicuously absent despite the abundant sunlight. *Halimeda* sp., encrusting coralline algae, encrusting sponges, and tunicate colonies are common on vertical or near-vertical faces. Small colonies of the corals *Porites* sp., *Pocillopora* sp. and *Leptastrea* sp. were seen. The most abundant macrofaunal invertebrate was the antipatharian, *Cirripathes arguineb*, with densities ranging from one per square meter near the bottom of this zone to about eight to ten per square meter near the top of the zone. Relief decreases toward the bottom of the zone and echinoderms become more abundant. The sea cucumber, *Holothuria atra*, and the urchin, *Chondrocidarus gigantea*, are most conspicuous.

1.5.3.4 The Upper Sand Plain

The upper sand plain is the region of depths between about 80 and 110 meters. From 80 to 90 meters depth the substratum consists of evenly distributed fist-sized lava rocks, but at 90 meters there is an abrupt transition to a sandy bottom. The sediment surfaces in this zone show gastropod trails, burrow openings, mounds and pits. The deeper areas have darker surfaces, presumably films of epibenthic algae or diatoms. *Halimeda* is present. The only macro-invertebrates seen were the echinoderms *C. gigantea*, *H. atra* and the burrowing nemertean *Cerianthis*. Burrowing fish and eels were present as well. Hard surfaces such as the cold water pipe were abundantly colonized by coralline algae, *Halimeda*, sponges, tunicates, barnacles and other sessile invertebrates. An extensive algal mat was present on rocks. Enormous aggregations of *taepe* (*Lutjanus kasmira*) were present between 75 and 90 meters. Also present were numerous large acanthurids (*Naso* sp.), holocentrids, muraenids, *C. milliaris* and *H. diphretes*.

1.5.3.5 The Lower Sand Plain

The lower sand plain extends between the depths of 110 and 150 meters. The substratum is a gentle sandy slope. At about 120 meters, the sediments become larger, greater than 4 mm, and organic content is higher. These coarse-grained sediments are dark with encrustation, and bioturbation features are more common. Fine white sediments are apparent under the armored surface. Some *Halimeda* is

present below 125 meters. *C. gigantea* is present and numerous dead pen shells (*Pinna* sp.) were seen. A moderate fish population was present consisting mostly of holocentrids and anthiines.

1.5.3.6 Deeper Water

Below 160 meters the slope again increases to about 40 degrees. The hard substratum shows less encrustation than at shallower depths and algal turfs are absent. Sponges, tunicates, hydroids, gorgonians and a small ahermatypic coral were present. The most commonly seen organisms were red and white banded shrimp.

Harrison proposes the following dynamic scenario for the region. The calcareous sediments are generated along the Kohala Terrace and transported southward by the prevailing nearshore currents. They are deflected offshore by Ke-ahole Point, enter a region of oscillatory currents, and accumulate at the foot of the nearshore slope. Sand contours normal to the shoreline are seen in the upper reaches of the sand plain. Moving downslope, the sediments are winnowed, leaving the heavier particles behind to armor the surface. Periodic intrusions of nutrient-rich water promote increased infaunal and epifaunal biota. The upper sand plain contains an abundance of micromollusks, burrows and pits, and large populations of *taepe*, implying a substantial infaunal community. In the lower sand plain, sediments are more stable, but evidence implies periods of high-energy water motion, and again the major heterotrophic component of this region is cryptic.

In the nearshore slope region, a continuous rain of sand particles falls on high-relief horizontal surfaces, discouraging settlement of the epibiota found on vertical or overhanging rock faces. In areas of lower relief, similar smothering occurs and is accompanied by periodic intense scouring by shifting sands. In addition to these physical factors, the predominantly herbivorous fish fauna suggests that grazing eliminates most fleshy macrophytes. Thus, exposed benthic communities on the nearshore slope are understandably sparse. However, where surfaces are protected, a variety of sessile filter-feeders colonize, demonstrating that food resources are not the limiting factor in this region.

In the upper sand plain, hard substrata are also subject to smothering. However, where protection exists, extensive communities of primary producers and heterotrophs develop. Here again, the encrusting fauna are dominated by filter-feeders, the result of an abundance of current-borne food particles. In contrast to the nearshore slope zone, the upper sand plain supports extensive crops of autotrophic macrophytes. The region is highly productive, and this is evidenced by the numbers and diversity of the fish community. Planktivores are notable in this group, and assume even more importance in the roll-off region below 160 meters.

Harrison concludes from physical oceanographic and chemical mass balance considerations that future effluent discharges into this area are unlikely to significantly negatively impact the benthic community. Currents offshore will rapidly disperse effluents and excess particulate organic material. Additions of dissolved nutrients will stimulate uptake by phytoplankton, but any growth response will require a lag on the order of a day or two, during which time the population is being advected away from the discharge. The trophic subsidies resulting from deposition of particulates near any outfall would not be expected to noticeably alter the existing

community structure because the factors apparently limiting the benthic communities in the area are physical stresses imposed by scour and sandfall.

1.6 Recreational Activities in the Project Area

The four miles of rocky shoreline from Kaloko to Keahole Point are backed by a long, sandy reach of storm beach that is frequented by beachcombers, campers, fishermen, sunbathers, picnickers, surfers, and scuba divers. The two most popular sites on this beach are "Pine Trees" and Wawaloli Beach.

The Keahole Point region is of high value for shoreline and ocean recreation on both a regional and island-wide scale. Although the entire area is undeveloped except for the NELH facility, it receives high use as a wilderness beach park. In the entire district of Kona, which begins at Manuka to the south and extends to Anaehoohomalu in the north, there is only one public beach park where camping is permitted--remote Milolii Beach Park. The proximity and security (the NELH access road is locked from 8:00 p.m. to 6:00 a.m.) of the Keahole shoreline have made it a highly desirable site. In addition to camping, the area offers many excellent opportunities for a variety of ocean recreation, including one of the best surfing sites and one of the best scuba diving sites in the Kona district.

The four-and-one-half miles of rocky shoreline from Keahole Point to Mahaiula consist of low sea cliffs, some of them veneered by storm beaches of black sand. Makolea Beach is the only beach along this reach where the sand meets the ocean. This area is less accessible than the area immediately south of Keahole Point and it attracts primarily pole fishermen with four-wheel drive vehicles.

1.6.1 Unualoha Point - Keahole Point

Access to NELH and to the shoreline is along a paved road which joins the main highway. A jeep road reaches the shoreline from the main highway north of Unualoha Point. A rugged jeep trail parallels the coast between these access routes and provides access to shoreline fishing sites. The County of Hawaii use permit and the State as landlord require that the jeep road be kept open at all times for shore access. The NELH intake pipes go through a culvert under this road.

Rocky headlands, especially Unualoha Point, are used by pole fishermen. Collecting of the popular nori variety of seaweed is popular during the winter months along the rocky coast from Unualoha Point to Ho'ona Bay. Coastal areas near Ho'ona Bay are camping and picnicking sites (Nolan and Cheney, 1981).

1.6.2 Keahole Point - Wawaloli Beach

Keahole Point and other rocky headlands are used by pole fishermen. Nori is collected in the winter months. Opihi picking is no longer common as most were harvested from shoreline rocks long ago. There is intensive use of the nearshore waters by sport divers and by fishermen trolling from boats which pass close to Keahole Point (Nolan and Cheney, 1981).

Wawaloli Beach is accessible from the NELH access road. This is a storm beach that borders a large tidal pond, an attractive wading site for children. Throw net fishing is practiced from the wave-washed benches along the shoreline (Nolan and Cheney, 1981).

1.6.3 Wawaloli Beach - Wawahiwa'a Point

The shoreline is subject to heavy recreational use. Access is by the NELH access road to the north or by a jeep road entering directly from the main highway and paralleling most of the shoreline. Much of this road is extremely rugged and nearly impassable even by off-road vehicles, but it serves as an important wilderness ocean recreation site. A substantial number of campers and fishermen use this area. Shorecasting and pole fishing are concentrated at Puhili and Wawahiwa'a Points. Nori is collected along the rocky shoreline during the winter months.

Throw net fishermen use the wave-washed benches. Nearshore waters are extremely popular as a sport diving site and charter dive destination. Prime diving sites include a vertical lava face off Puhili Point and a sea cave and arch near Wawahiwa'a Point. The surfing site known as "Pine Trees" is located south of Wawaloli Beach directly offshore from a stand of mangroves. In addition to being one of the best board surfing sites in the Kona district, "Pine Trees" is one of the State's most popular and most fascinating dive sites.

The abundance of numerous species of juvenile reef fishes causes this area to be frequently visited by aquarium fish collectors. Several commercially-valuable food and game fish are also relatively common (Nolan and Cheney, 1981).

2.0 Alternatives to the Action

2.1 Improvements Within the Marine Environment

2.1.1 Existing Structures

At present, three 12-inch diameter pipes supply ocean water to the NELH. A cold water pipe (CWP) extends about a mile offshore to bring water from 2,000 feet depths. Below about 500 feet this pipe is buoyed above the bottom to avoid abrasion. In-line, submersible pumps are located at about -25 feet.

One warm water pipe (WWP) is positioned at the base of the shoreline cliff in about 15 feet deep water, and the other WWP extends about 300 feet offshore to water depths of about 80 feet and draws from about 30 feet below the surface.

In addition to the pipes supplying the NELH, offshore of Keahole there is a 75-foot long section of 8-foot diameter pipe in water 75-125 feet deep. This pipe was used to demonstrate installation of a large-diameter pipe on a steep slope, and it will be removed in the near future.

2.1.2 Anticipated Structures and Seawater Return Flows

The ocean water requirements of the HOST Park are estimated to be 20,000 gpm of cold water and 80,000 gpm of warm water. One 48-inch or several pipes of 24-inch

diameter may be employed to bring water from a depth of 2000 feet. Warm water will be provided through one or more pipelines into nearshore waters. A WWP system serving the HOST park would probably be located south of Keahole Point. Pipelines will either be buried or armored through the nearshore zone to protect them from wave forces. Mixed seawater will be returned to the ocean via a trench system utilizing the unsaturated surface lavas at the site. The trench will have no direct connection to the ocean; it will be inland about 2,000 feet. Total seawater return flows could eventually reach 144 mgd. Dames and Moore (1985) modeled the groundwater plume which would be created by this return flow. Their report states that "...injection of the quantities of water projected would overwhelm the existing groundwater system....The disposal of ocean water would disrupt and displace the Ghyben-Herzberg lens for some distance inland and for a determinable width from the well to the coast. The injected water would travel as a plume surrounded by a zone of dispersion. Over the width of the plume, injected salt water would constitute the discharge front at the coast....For the HOST park initial increment of 20 mgd (13,900 gpm) the plume would be 2.7 miles wide at the shoreline and would reach 0.9 mile inland. For the total HOST Park discharge of 144 mgd (100,000 gpm) the plume would be 22.4 miles wide at the shoreline and would reach 2.4 miles inland." However, to reach this theoretical maximum would require maximum pumping for 12,900 years. It would take 30 years to reach 1.5 miles along the coast. The authors calculate that significant discharges would be constrained to a distance of 8,000 feet along the shoreline, and from sealevel to 400 feet depths. Within this area, discharges would average 2 gallons per day per square foot of bottom area.

Dames and Moore (1985) also analyzed the impacts of sewage disposal from the HOST Park. They estimate that a maximum of 211,000 gpd would be generated and disposed of into septic tanks with associated leaching fields. Sewage discharge volumes are approximately 0.15 percent of the seawater return. Groundwater effects would be insignificant. While resident in the groundwater, sewage effluents would be significantly diluted, filtered and biologically treated through natural processes. Discharged muck of the seawater return, these wastes would be carried inland and then laterally before returning to the sea following residence times measured in decades.

In addition to the HOST park improvements, the U.S. Dept. of Energy is to install a 30-inch cold water pipe, a warm water system and a mixed discharge to supplement the existing 12-inch pipe at NELH. Water requirements are 6,500 gpm of cold water (from 2,000 feet) and 9,500 gpm of warm water (from 40 feet). Mixed seawater is to be returned to the ocean at a depth of 200 feet through a 48-inch pipe. Noda (1985) modeled the behavior of the plume as follows. "The mixed-water discharge plume, being colder and denser than ambient waters at the 200-foot depth of discharge, would remain submerged. The initial momentum-dominated plume would flow along the bottom until reaching equilibrium density with the surrounding water, whereupon the plume will spread laterally and be advected away from the area by the nearshore currents.... (The plume) will have little potential for impacting either the warm water intake sources or the cold water intake sources at Keahole Point and the HOST Park. The discharge plume is expected to remain on the shelf region at depths greater than 200 feet and shallower than 400 feet."

Hawaiian Abalone Farms (HAF) plans to deploy two 15-inch pipes in the existing offshore research corridor.

2.2 Potential Uses of the HOST Park

2.2.1 Cold Ocean-Water Commercial Use

This category includes high-intensity aquaculture, marine biotechnology, and renewable energy production such as OTEC.

Experiments at NELH have evaluated the technical and economic feasibility of rearing aquaculture crops in OTEC discharges. To date, crops which have been evaluated include Maine lobsters, salmon, rainbow trout, nori, spirulina, oysters and abalone. The abalone concept seems viable, and a major scale-up is in progress.

Conceivably, potential crops include marine algae, crustaceans, mollusks, finfish, or integrations of the above.

2.2.2 Campus Industrial

Potential uses include high tech assembly, pharmaceuticals development (possibly using intermediate aquacultured products), a training institute, desalination equipment manufacture, software production, electronics design and assembly, biotechnology development, telecommunications and tropical agriculture.

2.2.3 Visitor, Recreation and Support Functions

The shoreline will be retained for public use, and a restroom and paved parking area will be provided. A visitor center, a restaurant, and possibly an oceanarium could be provided.

2.3 HOST Park Development Scenarios

A. No restrictions would be placed on cold water delivery. High intensity aquaculture and other cold-water uses would consume 83 percent of the site, while 17 percent would be used for support services, education, visitors' center, etc.

B. Cold water would be provided to the 100-foot elevation. The distribution of area would be 61 percent cold water users and 39 percent higher density uses.

C. Cold water would be provided to the 80-foot elevation. The distribution of area would be 35 percent cold water users and 65 percent higher density uses.

2.4 Potential Uses of the NELH

The NELH master plan provides for research related to the development of OTEC, solar energy and mariculture/biomass conversion. A number of experiments of this nature have been completed.

Specific plans exist for the development of a greatly expanded facility for open-cycle OTEC research while continuing the present closed-cycle OTEC experimentation

including biofouling and corrosion experiments. Large-scale tests of aluminum heat exchanger elements are planned.

Other potential types of development which could impact the marine environment include solar ponds, desalination, agriculture, materials testing, manufacturing and processing.

3.0 Impacts and Mitigating Measures

3.1 Limitations of Impact Assessment

Lack of a more detailed construction plan and uncertainty about the exact nature of future activities by NELH-HOST tenants lends a high degree of uncertainty to assessment of potential impacts on biota and ocean recreation in the Keahole Point region. Future maintenance of environmental quality will require careful scrutiny on a case-by-case basis of all intended facilities and operations for compatibility with this environment and its intended uses. Often, impacts can be mitigated in the design of the project through awareness and avoidance of offshore areas of special biological or recreational importance.

As many as 10 ocean water intake pipelines could be installed offshore of the NELH-HOST site. Each additional offshore pipe will have many of the impacts discussed below, and even if the impacts of a few pipes are judged minimal, there is probably a point at which the cumulative impacts would be unacceptable. This fact argues strongly for maximum utilization of whatever pipes are emplaced and water is pumped. Wherever possible, water should be used for several successive purposes before being returned to the ocean.

3.2 Construction

The first impacts on biota and ocean recreation would be through alteration of marine habitats and recreational sites as a result of the construction of pipelines. Key aspects of any construction scenario would include drilling, blasting, trenching, pipe installation, backfilling and armorings or anchoring. The potential impacts of these actions are discussed in the sections below.

3.2.1 Drilling and Blasting

Drilling and blasting is anticipated to be required for excavation due to the hardness of the basalt material. Drilling is necessary prior to blasting. Typically, either a temporary trestle or a jack up walking drill barge might be used as a working platform (Parsons Hawaii, 1984). The porosity of the rock formations in the area lowers the efficiency of explosives so that large quantities of high-speed explosives will be required for rock breaking. Nevertheless, unlike coral limestone, the dense basalts would generate relatively little silt during operations. Bienfang (1975) reports no significant adverse impacts to the marine environment from dredging of Honokohau Harbor. From his results, it was calculated (Noda, 1985) that about 2.3 percent of the dredged material volume was sediments in the fine sand to silt size range, and that if the same ratio held, only about 2 cubic yards (cy) of silts would be generated by dredging for the HOST Park CWP if it were located off Keahole Point. This would be dispersed over distances of three to seventy miles. If the pipe were installed offshore

of the HOST Park, the total silt volume generated would be 30 cy, considering a sandier substratum. In the latter event, maximum sediment thickness, in the absence of any currents, would be 1 mm over a 500 x 500 foot area.

Impacts of construction would be transient for the most part. Use of any type of bottom-fixed platform or trestle would disrupt bottom communities in the immediate impact area, as will blasting. Corals in particular are susceptible to this type of physical damage. Coral destruction reduces the amount of habitat available to other species. Presence of a fixed structure will attract fish and invertebrates.

Drilling and blasting will both produce noise, and blasting will produce shock waves in the water. The impact of drilling noise will be transient; some localized behavioral modifications can be expected among motile organisms. Shock waves generated by the blasting will cause mortalities in sufficiently near fish, turtles, or mammals. Of most concern are the potential effects on the endangered humpback whale and the threatened green turtle. Because of these potential impacts, other similar blasting operations in the state have employed specific mitigation measures including prohibition of blasting while whales are present in Hawaiian waters, visual surveys of the area prior to blasting, limitations on charge size and use of shaped charges to minimize shock waves. Coordination with the National Marine Fisheries Service will be necessary to develop specific measures for this project.

Other impacts of drilling and blasting will include a temporary reduction in water quality and undoubtedly a temporary loss of recreational access.

3.2.2 Trenching and Backfilling

Noda (1985) projects that the trench length offshore of the NELH would be about 100 feet whereas a trench offshore of the HOST Park would be about 400 feet long. For a 48-inch HOST Park CWP off Keahole Point, the estimated offshore excavation volume is 90 cy. Estimated offshore excavation quantities are 890 cy and 400 cy for the HOST Park CWP and WWP, respectively.

Blasted rock could be mucked out by clamshell or dragline and is commonly cast to a convenient under-water stockpile for later use (Parsons Hawaii, 1984).

Underwater earthwork will have a temporary negative impact on water quality, but circulation and flushing in this area are sufficient to minimize this impact.

Obviously, benthic organisms in the line of the trench will be displaced or destroyed. For a single pipeline, the area affected would not be large. For the maximum ten pipelines, however, significant damage could result. If an under-water stockpile is used, benthic biota in this area would also be smothered or crushed.

The most important factor influencing the reef fish fauna seems to be coral cover. Dense colonies of the finger coral at depths below -50 feet serve as an important nursery ground for juvenile fishes. Damage to these coral beds during the placement of offshore pipelines would be detrimental to fish populations.

3.2.3 Red Tides and Ciguatera

New surfaces of pipelines and those created by dredging or blasting have the potential to stimulate the development of ciguatera food chains. Ciguatera is a form of fish poisoning caused by human consumption of fish whose tissues contain a paralytic neurotoxin. Several species of microscopic, unicellular algae which grow primarily attached to larger seaweeds have been implicated as the source of ciguatera in the Pacific. Blooms of the one-celled algae apparently initiate the transfer of toxic material through the marine food chain until it becomes concentrated in the tissues of certain species of food fish. The environmental conditions which trigger massive blooms of the algae are not known, although conditions which have been repeatedly associated with ciguatera are dredging of reef areas, sunken ships, and rainfall-runoff patterns.

Incidents of ciguatera poisoning in Hawaii have sometimes been connected with construction activities which have exposed new submerged surfaces through dredging. A small bloom of one species of toxic algae occurred at Pokai Bay in August 1978, coincident with the dredging of a small boat harbor nearby and with an outbreak of ciguatera in fish from that area.

To date, no one can predict whether or not a given construction activity in the marine environment will lead to incidences of ciguatera poisoning. Extensive dredging of Honokohau Harbor and Kawaihae Harbor on the island of Hawaii occurred without known incident. The only mitigating measure possible is to monitor newly exposed submarine surfaces and newly-deployed pipeline surfaces for blooms of the suspected algae (*Gambierdiscus toxicus*). It is possible that minimizing disturbances of the bottom during construction will reduce the likelihood of ciguatera, but current information is not adequate to predict or prevent such an occurrence (Myers, et al., 1985).

Blooms of certain species of phytoplankton which cause red tide can also make fish inedible. Red tides are observed annually immediately north of Keahole at Maheula (Clark, in press). There is a large volume of fresh water intrusion in the inner bay at Maheula. Based on the theory that most red tide outbreaks are associated with terrestrial runoff, they would not be expected as a consequence of salt-water operations.

3.2.4 Pipeline Installation

There are basically two ways to install a CWP. The first, and environmentally preferable, method is to float the pipeline into place and then sink it. This is the method that was used to replace the existing NELH CWP, and is the method expected to be used to replace other pipelines associated with the development of the NELH-HOST Park complex. This procedure causes the minimum amount of damage to benthic communities. The other method is to drag the pipe out from shore, splicing successive sections onto the shoreward end. This method has the potential to destroy corals along a broad swath if there is lateral movement of the pipe during deployment.

3.3 Pipeline Presence

The physical presence of pipelines offshore of the NELH-HOST Park will modify the benthic environment and possibly the recreational potential in the area.

3.3.1 Habitat Effects

In the trenched areas, few long-term negative impacts could be anticipated. Infaunal communities will lose a small amount of habitat, but this will not be significant. Epibenthic communities can be expected to recolonize the disturbed surface in a relatively short time.

Seaward of the trenched areas, the pipelines will be anchored to the seafloor, and possibly, armored. In terms of the amount and quality of new habitat, the latter would be preferable.

The attraction of bottom-dwelling fishes to man-made structures placed on the ocean floor is well documented. Bottom areas of substantial vertical-dimension heterogeneity are known to harbor a more diverse and larger biomass of fishes (and invertebrates) than relatively featureless bottoms. Generally in shallow waters, corals are a major structural element of this vertical relief. The habitat complexity created by an offshore pipeline as it runs shoreward across the featureless sandy terrace at depths from -300 to -500 feet offshore of Keahole could enhance its fish attracting qualities. Experience with artificial reefs in Japan has shown that total reef horizontal area is a critical factor in their effectiveness as fish attractors (Grove and Sonu, 1983). The pipelines deployed to serve the NELH-HOST Park site would afford little horizontal area and, hence, may not function particularly well as artificial reefs.

The species composition and abundance of the fish assemblage which might be attracted to pipelines constructed offshore of Keahole are a matter of conjecture. In all probability, it would include a mix of reef species (surgeonfishes, squirrelfishes), some pelagic wandering species (jacks, opelu), and some of the deepsea bottomfish species. The latter group could include commercially-desirable species such as uku (*Aprion virescens*) and opakapaka (*Pristipomoides filamentosus*) or it could be dominated by the nuisance tarape species (*Lutjanus kasmira*). Pipelines are unlikely to contribute much to attracting fish in shallower regions where the rocky bottom already has considerable natural relief or where dense coral beds afford considerable habitat for reef fishes.

3.3.2 Pipe Composition

HDPE pipe is expected to be used for CWPs for NELH and the HOST Park. This high density material has been chosen because of certain of its physical properties, primarily its insulating characteristics and its extreme smoothness. Because of its smoothness, it resists growth of encrusting species better than other types of pipe, and its value as artificial habitat is reduced.

3.3.3 Recreation Effects

The Keahole region is one of the most important in the State for sport diving, as well as for commercial collecting of aquarium fish. In addition, the best board surfing site in the district of Kona is located nearby.

Large-diameter pipelines crossing the nearshore area off Keahole may not be aesthetically pleasing to sport divers, but would have minimal impact on other users of the area.

3.4 Operation

Operation of the HOST Park would impact the marine environment through seawater intake and various potential types of discharges.

3.4.1 Intake Pipes

The primary impact of intake pipes will be impingement and entrainment of organisms. Impingement refers to larger organisms caught on protective screens positioned at some point in front of the pumping system. Entrainment affects smaller organisms like plankton, which may pass entirely through the pumping system.

The impingement and entrainment effects of a CWP will be minimal because of the relative sparsity of organisms at that depth. The effects of a WWP are of more concern, and are the focus of the discussion below.

3.4.1.1 Impingement and Entrainment

Impingement and entrainment effects on the plankton community are not expected to be significant because of the large numbers of these ubiquitous organisms and their short generation times. The most vulnerable component of the shallow water fauna is the larval fish. Commercial and recreational fisheries depend on steady recruitment of small fish to provide harvestable stocks of larger fish. Mortalities of larval fish due to impingement on pipe intake screens or entrainment in intake water could theoretically reach proportions which may cause population damage. However, impingement or entrainment would only be a factor on warm water intakes placed where larval fish are concentrated. The eggs and larvae of most commercially-important fish are buoyant and tend to reside near or at the surface. Few larvae are found below 200 meters depth. Little impingement or entrainment is expected from cold water intakes placed at a depth of 2,000 feet. However, secondary entrainment of organisms is possible in seawater returns, especially from pipes which would create a coherent plume.

There is presently no conclusive evidence of actual declines in any fishery due to impingement or entrainment losses (Myers, et al., 1985). However, reef fish or bottomfish stocks which are being heavily fished may not be able to compensate for the individuals lost through entrainment or impingement and yield could be affected. Knowledge of the survival of these early life stages of the major commercial species is too incomplete to predict the impact on yield (Myers, et al., 1985). Total mortality of all fish eggs, larvae, and juveniles directly entrained could be assumed (Matsumoto, 1984).

Recruitment of juvenile fishes to reefs in Kona, Hawaii was monitored by Walsh (1980), who found that many species exhibited strikingly low levels of recruitment over a 51-month period. Loss of larval fish to offshore or other unfavorable currents may be responsible for low levels of juvenile recruitment in this and other

Hawaii studies. The patterns of recruitment observed appeared to be most closely tied to changes in water temperature and/or photoperiod (Walsh, 1984). These conditions could enhance any adverse effects of impingement or entrainment.

The impact on fisheries will be largely through the recruitment process. Although many hundreds of thousands of eggs may be released by a female reef fish or bottomfish during the course of a year, most of this reproductive material is swept out to sea and is lost from the reef systems. Eventually, some larvae make it back to a reef to continue the population. These recruits are often the result of the reproductive activities of other fishes upcurrent of that reef, except for the fish species which brood their young. If habitat is not disturbed, but the fish are removed, the reef can repopulate itself at rates which are determined by the larval reservoir upcurrent. Hence, any potential adverse effects of impingement or entrainment on reef and bottom-associated fish recruitment would most likely be felt in areas downstream from the HOST site. If the prevailing currents are disrupted so that eggs and larvae are carried away from potential settlement areas, the full impact might not be immediately apparent directly offshore of the project site.

The ability of larger fish to avoid the intake flow fields can be maximized by keeping the flow speeds as low as practicable. In this respect, the larger the diameter of the pipe, the better. Intakes should be located away from areas of biological importance. Impacts on the fishery due to impingement and entrainment are expected to be negligible compared to other pressures on local fisheries.

3.4.2 Discharges

The number of possible pipelines and the potentially very large volumes of seawater to be pumped through the NELH-HOST site create a potential for changes of water properties in the near-surface part of the water column similar to those caused by natural upwelling of nutrient-rich and trace-metal rich, cold waters from great depths. Seawater return methods anticipated include use of a discharge pipe for NELH OTEC operations and disposal into the groundwater at the HOST Park site.

3.4.2.1 OTEC

Noda (1985) modeled the NELH OTEC discharge plume. It is projected that 16,000 gpm will be discharged at a depth of 200 feet. Because the mixed-water discharge will be more dense than the ambient waters at this depth, the plume will flow along the bottom until it reaches equilibrium density with the surrounding water. At this point, the plume will spread laterally and be advected away by currents. The OTEC water will contain high concentrations of nutrients, high concentrations of some trace metals and low oxygen concentrations. It will also be relatively low in temperature.

The elevated nutrient concentrations will have no impact because the discharge will be below the photic zone. Of greatest impact will be the low temperatures and depressed oxygen concentrations in the discharge. The model predicts that the plume will flow along the bottom until it attains equilibrium density. This means that the non-mobile components of the benthic environment will experience a

significantly altered medium. While lethal effects may not be noted, sublethal impacts such as reduced growth rates will certainly occur. It may be that the fauna in the path of the plume will come to resemble that at much deeper depths.

Both OTEC and aquaculture return flows will contain chlorine at certain times. Chlorine breaks down very rapidly in seawater, but it produces more toxic hydrogenated by-products which may bioaccumulate. More specific plans are required to evaluate these potential impacts, but research at NELH has shown that very small quantities of chlorine, generated electrically inside the pipes, is extremely effective in controlling biofouling.

Another concern is potential additions of metals from deep waters or from heat exchangers. Elevated metals concentrations are not expected to have adverse impacts on waters in and below the thermocline.

3.4.2.2 Aquaculture

It is anticipated that seawater return flows from both NELH and the HOST Park will be disposed of behind the shoreline, into a large trench from which they will move toward the coast. The groundwater system will be overwhelmed, and the anchialine ponds will lose their brackish character. If mitigation of this impact is desirable, it should be easy to artificially create new anchialine ponds by digging pits to intersect the water table at nearshore locations out of the zone of impact of the seawater return flow. Care should be taken not to generate large quantities of silt in this process as this would tend to accelerate aging of the ponds.

Of more importance are the potential effects of the seawater return flow as it seeps into nearshore waters. The return waters will be high in ammonia, other nutrients, suspended particulate matter and dissolved organic compounds. Disposal into the groundwater and the relatively long residence time before a slug reaches the coast will provide a natural treatment process. Particulates will be filtered out; chlorine and any other treatment chemicals will be greatly diluted. Organics will be broken down through bacterial action.

Nutrient loading has the potential to create biostimulation. However, at present, benthic algae are very closely cropped by herbivorous fish. It could be assumed that this pattern would continue, and the biomass response would be seen at the herbivore or higher trophic level, not at the producer level. If the phytoplankton were stimulated, the natural flushing and circulation of this area, coupled with the lag between nutrient uptake and phytoplankton growth, would result in relatively slight stimulation over a large area. Here again, most likely, the biomass effects would be seen at higher trophic levels.

The most serious potential impact arises from the temperature and density of the seawater return flow. According to Dames and Moore (1985), the area of significant discharge would encompass an area of about 8,000 feet along the shoreline out to depths of 400 feet. Typically in this area, the groundwater discharge consists of brackish water which, although cold, because of its low salinity, is significantly less dense than the receiving waters and thus tends to flow seaward in a surface lens. If this flow is replaced with seawater of about ambient salinity but significantly cooler temperature compared to the receiving water, this

denser return flow will form a bottom layer rather than a surface layer. Because this water will be cooler than ambient, detrimental effects could be experienced by the coral community. Corals are very temperature sensitive, and the typical temperatures of Hawaiian waters do not provide a great margin for reduction. If the seawater return flows consist solely of cold (10°C) water, corals could be killed for some distance along the coast, depending on plume advection.

The proposed seawater return flows for the HOST Park at full development are projected at 20,000 gpm cold water and 80,000 gpm warm water. The temperature of the cold water is estimated to be approximately 10°C and that of the warm water 20-22°C. The mixed water discharge will have an average temperature of approximately 19°C and would be sufficiently warm to avoid coral mortality. However, if cold water aquaculture is dominant, which could be the case in the early stages of park development, the temperature of the return flow would be cold enough to cause coral damage. At NELH, the return flows are expected to be solely cold water.

The problem can be alleviated by warming the water before discharge. This can be done by retaining the water for a period of time before discharge to allow warming by sunlight, either by reusing the water for warmwater aquaculture or in holding ponds, or by running the water through a series of small pipes.

Another alternative is to use outfalls to discharge the seawater to the ocean. This would require outfall pipes equal in size and number to the intake pipes, doubling the adverse impacts associated with pipe construction and presence in the shoreline.

3.4.2.3 Sanitary Wastes

Each tenant will be responsible for his own sewage collection, treatment and disposal. Dames and Moore (1985) recommend the use of septic tanks and leaching fields to protect the groundwater. They estimate that sewage discharge volumes will be 0.15 percent of the seawater return, and dilution and residence time in the ground will render any effects insignificant.

3.4.2.4 Laboratory, Industrial and Process Wastes

All such wastes will require pretreatment to remove toxic substances prior to disposal.

3.5 Increased Accessibility and Impact on Recreation

The Keahole Point region is the most important wilderness ocean recreation area in the district of Kona. Despite the need for four-wheel drive vehicles to gain access to much of the coast, the shoreline is heavily used.

Improvement of physical access to the shoreline below the NELH-HOST site should be avoided, as it would only lead to overuse and congestion. This would reduce the quality of the ocean recreation which is so attractive to present users. A visitor center is planned for the NELH-HOST facility. This should be sited within the developed portion of the property and should not be sited near the shoreline. A

shoreline visitor center would only increase vehicular and pedestrian traffic along a section of an important wilderness ocean recreation area that is already heavily used.

If the NELH-HOST facility accomplishes its purpose on a large scale, it could become a major employment center in the Kona district. If this occurs, employees can be expected to become regular users of the Keahole shoreline, and the wilderness quality of this shoreline will inevitably be reduced.

3.4 Catastrophic Events

According to Bretschneider (1979), the maximum wave height which could be expected at Keahole Point is 49.7 feet from the south southeast to the south southwest. This would occur during a winter, "Kona" storm.

In 100 years of recordkeeping, there have been no recorded instances of hurricanes hitting the Kona area.

The Kona area is somewhat shielded from direct tsunami impact, but sea level rises may occur. The rise associated with the 1946 tsunami measured 11.5 feet.

Catastrophic events may impact the marine environment through the release of organisms or chemicals into coastal waters. The effects of chemical introductions could be quite serious depending on type and quantity. Neither of these variables are known at this time, however.

REFERENCES

- Belazs, G.H. 1980. Synopsis of Biological Data on the Green Turtle in the Hawaiian Islands. NOAA-TM-NMFS-SWFC-7. 141p.
- Bathen, K.H., R.M. Kamins, D. Kornreich and J.E.T. Moncur. 1975. An Evaluation of Oceanographic and Socio-Economic Aspects of a Nearshore Ocean Thermal Energy Conversion Pilot Plant in Subtropical Hawaiian Waters.
- Bienfang, P.K. 1975. The Oceanography of Honokohau Harbor, Hawaii. Appendix B, EIS for Honokohau Harbor, Harbors Div. State of Hawaii.
- Bretschneider, C.O. 1978. An Evaluation of Extreme Wave Climates at Keahole Point, Hawaii. Proc. 16th International Conference on Coastal Engineering, Hamburg, Germany.
- Brewer, W.A., J.P. Huizingh and J.A. Sexton. 1985. Hawaii's OTEC Park Triggers High-tech Aquaculture Development. INFOFISH Marketing Digest No. 1/85, 18-21.
- Brock, J.H. and R.E. Brock. 1974. The Marine Fauna of the Coast of Northern Kona, Hawaii. UNIH-SEAGRANT-AR-74-02. 30p.
- Clark, J.R.K. In press. The Beaches of the Big Island of Hawaii. Univ. Hawaii Press.
- Dames & Moore. 1985. High Technology Development Corporation Keahole Wells. Draft.
- Dollar, S.J. 1977. Coral Communities of Puako, Anaeohomalu, and Kiholo Bays. p. 33-53 In: Hydrologic and Ecologic Inventories of the Coastal Waters of West Hawaii, E. A. Kay, et al. WRRRC Tech. Rept. No. 105, Seagrant Rept. UNIH-SEAGRANT-CR-77-02.
- Fischer, W.A., D.A. Davis and T.M. Souza. 1966. Fresh Water Springs of Hawaii from Infrared Images. U.S.G.S., Hydrology Inventory, Atlas HA-218.
- Gordon, D.C. 1970. Chemical and Biological Observations at Station Gollum, An Oceanic Station Near Hawaii, January 1969 to June 1970. Univ. of Hawaii Inst. of Geophysics, HIG-70-22.
- Grove, R.S., and C.I. Sonu. 1983. Review of Japanese Fishing Reef Technology. Southern California Edison Co. 83-RD-137.
- Gundersen, K.R. 1974. A Study of Biological Nitrogen Transformations in the Water Masses of the North Central Pacific Ocean. Univ. of Hawaii Inst. of Geophysics, HIG-74-12.
- Harrison, J. 1985. Survey of Benthic Organisms from the Depths of 60 to 200 meters off Keahole Point, Hawaii. Draft. Marine Sciences Group, Univ. of Cal., Berkeley. MSG-85-007.
- Hawaii Department of Health. 1984. Water Quality Standards. Title 11, Administrative Rules, Chapter 54.

- Hawaii Department of Land and Natural Resources. 1970. An Inventory of Basic Water Resources Data: Island of Hawaii. Rept. R-34, Div. of Water and Land Development.
- Hawaii Department of Land and Natural Resources. 1980. Hawaii Coastal Zone Fisheries Management Study. 172 p.
- Helbert, Hastert, Van Horn & Kimura, Planners, et al. 1985. Hawaii Ocean Science and Technology Park, Marketing and Feasibility Studies. Prep. for High Technology Development Corporation.
- Holthuis, L.B. 1973. Caridean Shrimps Found in Land-locked Salt Water Pools at Four Indo-west Pacific Localities (Sinai Peninsula, Funafuti Atoll, Maui and Hawaii Islands), with the Description of One New Genus and Four New Species. Zool. Verh. No. 128.
- Leis, J.M. 1985. Review of the Early Life History of Tropical Groupers (Serranidae) and Snappers (Lutjanidae). Draft. Workshop on the Biology of Tropical Groupers and Snappers, held 20-22 May 1985, Honolulu, Hawaii.
- Lobel, P.S., and A.R. Robinson. 1984. Transport and Entrapment of Fish Larvae by Ocean Mesoscale Eddies and Currents in Hawaiian Waters. Draft. 48p.
- Macielek, J.A., and R.E. Brock. 1974. Aquatic Survey of the Kona Coast Ponds, Hawaii Island. UNJHI-SEAGRANT-AR-74-04. 73p.
- Matsumoto, W.M. 1984. Potential Impact of Ocean Thermal Energy Conversion (OTEC) Operation on Fisheries. Adm. Rept. H-84-4, Southw. Fish. Cent. Hon. Labor., Natl. Mar. Fish. Serv./NOAA, Honolulu. 29 p.
- Myers, E., D. Hoss, W. Matsumoto, D. Peters, M. Seki, R. Uchida, J. Ditmars, and R. Paddock. 1985. The Potential Impact of Ocean Thermal Energy Conversion (OTEC) on Fisheries. NOAA, National Ocean Service, Office of Ocean and Coastal Resource Management, Washington, D.C. Nine individually-paged sections.
- Noda, E.K., P.K. Bientang and D.A. Ziemann. 1980. OTEC Environmental Benchmark Survey off Keahole Point, Hawaii. Univ. of Hawaii, J.K.K. Look Lab. of Oceanographic Engineering Contract Report No. 80-1.
- Noda, E.K. & Associates. 1985. NELH/HOST Park EIS Technical Inputs.
- Nolan, R.S. 1978. Hawaii Tropical Reef Fish Study. p 27-34. In: Papers and Comments on Tropical Reef Fish. Working Paper No. 34. Sea Grant College Program, Univ. Hawaii, Honolulu.
- Nolan, R.S., and D.P. Cheney. 1981. West Hawaii Coral Reef Inventory. U.S. Army Corps of Engineers, Pacific Ocean Division, Ft. Shafter, Hawaii. 455p + appendices.
- Ocean Research Consulting and Analysis, Ltd. (ORCA). 1977. Coral reef survey: Keahole Point, Hawaii (winter months) for the Natural Energy Laboratory OTEC facility, State of Hawaii. Hawaii Dept. Planning and Economic Development. 115 p.
- Ocean Research Consulting and Analysis, Ltd. 1978. Coral reef survey: Keahole Point, Hawaii (summer months) for the Natural Energy Laboratory OTEC facility, State of Hawaii. Hawaii Dept. Planning and Economic Development. 119p.
- Parsons Hawaii. 1984. Conceptual Study of Onshore/Offshore Seawater Piping and Pump Station, Phase 1, Expanded Test Facility (ETF), Keahole Point, Hawaii.
- Sands, M.D. 1979. Environmental Assessment, Ocean Thermal Energy Conversion (OTEC) Program Pre-Operational Ocean Test Platform.
- Shallenberger, E.W. 1979. The Status of Hawaiian Cetaceans. Rept. Prep. for U.S. Marine Mammal Commission. 103p.
- Towill, R.M. Corp. 1982. Kona Ocean Outfall: Application for Secondary Treatment Requirements for Discharge into Marine Waters.
- U.S. Dept. of Commerce, NOAA, Office of Ocean and Coastal Resource Management, Sanctuary Programs Division, and Hawaii Dept. of Planning and Economic Development. 1983. Draft Management Plan and Environmental Impact Statement for the Proposed Hawaii Humpback Whale National Marine Sanctuary. Wash., D.C.
- Walsh, T.W. 1984. A Description of Water Quality Parameters Measured on Seawaters Collected During 1981 to 1983 at the Natural Energy Lab of Hawaii. Univ. of Hawaii, Institute of Marine Biology.
- Walsh, T.W. 1985. Environmental Survey of Keahole Point - Kailua Kona Hawaii: Water Quality Chemistry Baseline (NOV 1984). UH-HIMB.
- Walsh, W.J., III. 1984. Aspects of Nocturnal Shelter, Habitat Space, and Juvenile Recruitment in Hawaiian Coral Reef Species. Ph. D. dissert. (Zoology), Univ. Hawaii. 475 p.
- Water Resources Research Center, Univ. of Hawaii. 1980. Proposed Prototype Testing Program, Land Disposal by Injection Wells of Ocean Water Effluent at Seacoast Test Facility, Keahole Point, Hawaii.

APPENDIX G

**POTENTIAL SOCIO-ECONOMIC IMPACTS
NELH/HOST PARK**

**DECISION ANALYSTS, INC.
COMMUNITY RESOURCES, INC.
JUNE 1985**

**POTENTIAL SOCIO-ECONOMIC IMPACTS AND MITIGATING MEASURES OF
EXPANDING THE NATURAL ENERGY LABORATORY OF HAWAII AND
DEVELOPING THE HAWAII OCEAN SCIENCE & TECHNOLOGY PARK**

CONTENTS

	<u>Page</u>
DESCRIPTION OF EXISTING SOCIO-ECONOMIC ENVIRONMENT	1
Hawaii Island	1
North Kona	3
South Kona	5
South Kohala	7
POTENTIAL SOCIO-ECONOMIC IMPACTS AND MITIGATING MEASURES	8
Introductory Comments	8
Acreage Assumptions	9
Average Annual Construction Employment and Income	9
Operating Employment and Income	9
Impacts	9
Training and Education to Maximize Resident Employment	10
Maximization of Local Resident Access to Leases	17
Population	18
Housing	18
REFERENCES	31

PREPARED BY:

Bruce S. Piasch, Ph. D.
Decision Analysts Hawaii, Inc.
John M. Knox, Ph. D.
Community Resources, Inc.

July 1985

**POTENTIAL SOCIO-ECONOMIC IMPACTS AND MITIGATING MEASURES OF
EXPANDING THE NATURAL ENERGY LABORATORY OF HAWAII AND
DEVELOPING THE HAWAII OCEAN SCIENCE & TECHNOLOGY PARK**

TABLES

<u>Number</u>	<u>Page</u>
1-a. Total Population and Demographic Breakdowns: State of Hawaii, County of Hawaii, and Possible Affected Areas, 1970 and 1980.	22
1-b. Family Characteristics and Income Levels: State of Hawaii, County of Hawaii, and Possible Affected Areas, 1970 and 1980.	23
1-c. Labor Force Size and Characteristics: State of Hawaii, County of Hawaii, and Possible Affected Areas, 1970 and 1980.	24
1-d. Housing Stock and Characteristics: State of Hawaii, County of Hawaii, and Possible Affected Areas, 1970 and 1980.	25
2-a. Potential Socio-Economic Impacts: Acreage Assumptions.	26
2-b. Potential Socio-Economic Impacts: Average Annual Construction Employment and Income.	27
2-c. Potential Socio-Economic Impacts: Operating Employment and Income, Full Development.	28
2-d. Potential Socio-Economic Impacts: Population and Housing, Full Development.	30

DESCRIPTION OF EXISTING SOCIO-ECONOMIC ENVIRONMENT

Hawaii Island

The "Big Island" is the largest and least densely populated of the Hawaiian Islands. Its countywide government is centered in the East Hawaii town of Hilo, which was home to 40 percent of the island's 1980 population of 92,053. Estimated January 1984 islandwide resident population was 106,403 (Hawaii State Department of Planning and Economic Development, 1985b). In terms of 1970 - 1980 percentage increases, the fastest-growing parts of the island have been several relatively rural areas: North Kona, Puna, and South Kohala.

As indicated in Table 1-a, the island's population grew by nearly 50 percent in the 1970s, and the ethnic composition changed by becoming significantly less Japanese and more Caucasian and Hawaiian. Compared to the state as a whole, Hawaii County's 1980 population was more skewed to both the very young and the elderly age segments; had proportionately fewer recent in-migrants; was less educated; and was much more comprised of the Hawaii-born.

Big Island family characteristics closely matched those of the statewide population in 1980 (Table 1-b), but proportionately more families lived below the poverty line, and the median family income was about \$3,600 lower on Hawaii Island. Unemployment was significantly higher on the Big Island than it was statewide (Table 1-c), and there were proportionately fewer people working in the better-paid occupational categories (e.g., "managerial/professional" or "technical, sales, and administrative"). However, certain characteristics of the Big Island's housing situation (Table 1-d) were better than they were statewide: more affordable rents and housing values; less crowded households; higher available vacancy rates; and proportionately more owner-occupied households.

As of 1984, the average annual unemployment rate was 8.0 percent, highest of the four major counties in the state (State Department of Labor and Industrial Relations, unpublished records, personal communication, 1985). Economic conditions have generally been more troubled in East Hawaii, which is heavily dependent on agriculture, than in West Hawaii, where future economic and population growth are expected to occur at a more rapid rate.

Historically, Hawaii County's economy has centered on agri culture, with 22 percent of the estimated 1983 jobcount involving salaried or self-employed agricultural work or food processing (Hawaii State Department of Planning and Economic Development, 1985a, p. 355). This was the largest agriculture/food processing percentage for any Hawaii county.

Sugar has traditionally been the island's major agricultural crop. As of 1983, Hawaii Island had about 75,600 acres in sugarcane, which constituted 39 percent of the state's total sugarcane acreage and 76 percent of Hawaii Island's acreage in crops; the value of sales for the unprocessed cane was nearly \$100 million (ibid., p. 584). However, sugar's economic future is uncertain, and two Big Island plantations have closed in recent years—one in North Kohala in 1975 and the other in Puna in 1984.

In recent years, there has been significant growth in the nonsugar (or "diversified") portions of the Big Island agricultural sector—primarily macadamia nuts, nursery products, fruits, vegetables, and melons. Combined with livestock sales, the value of these crops was at least 90 percent of sugar's value in 1983, and the island's estimated 5,000 nonplantation agricultural production jobs (more than half of them involving self-employment and/or unpaid family workers) comprised about 60 percent of all such jobs in the state (ibid., pp. 355, 582). Diversified agriculture is expected to continue growing on the Big Island, but it is subject to shipping problems and limited markets; hence, it is not expected to replace sugar in the island's economy if there are further plantation closures.

Aquaculture development has been extremely limited on the Big Island. According to unpublished information provided by the Hawaii State Department of Land and Natural Resources, Aquaculture Development Program (personal communication, June 1985), there were only 21 small operations on the island in 1984, covering a total area of 44 acres and employing 31 full- or part-time workers. (These figures exclude the experimental facilities at the NELH.)

Although it is somewhat less important on the Big Island than in other Hawaii counties, tourism is the second most significant industry after agriculture. The

visitor industry was hard hit by the tourism slump of the late 1970s and early 1980s, but had recently begun to pick up until the 1985 United Airlines strike. Tourism has fared much better in sunny West Hawaii than around the Hilo area, and—as will be shortly discussed—it is expected that the industry will be increasingly centered in North Kona and, particularly, South Kohala.

A third and much smaller economic prop has involved scientific research and development. In addition to the NELH facilities in Kona, there have been a number of astronomical observatories built on Mauna Kea, as well as geothermal exploration (which may lead to commercial development) in Puna.

North Kona

The North Kona district is situated in the center of the West Hawaii coast. In precontact times, it was a seat of political power for Big Island native Hawaiian chiefs since at least the 15th century, and Kamehameha the Great made his final court at the village now known as Kailua (Hawaii County Department of Planning, 1982, pp. 7-11). In olden times, as well as today, the district's varying geography and climate dictated different major economic activities in the coastal region (fishing, water-oriented recreation, and now tourism) from those in the cooler and moister mountain slopes above (primarily agriculture and grazing).

Until the 1960s, North Kona's economy was dominated by the mauka agricultural activities, and the majority of its small population was supported by independent farming or ranching operations. The sometimes steep and rocky terrain frustrated attempts to establish large plantations for sugar or any other crop but coffee, and even the coffee plantations were broken up into small family farms following a collapse of the world coffee market at the turn of the century (ibid., pp. 19-20). Other than a few moderately-large ranches, therefore, North Kona had few major employers for the first half of the 20th century.

By 1970, however, agricultural employment had declined sharply, and the mauka-based visitor industry was the central prop of North Kona's economy. The initial growth area was in and around Kailua Village, which is still the district's commercial center. More recently, growth has also occurred at the Keaunou resort complex south of Kailua, and the draft Kona Regional Plan also calls for a new resort area to be initiated at Kealahou/Honokohau/Kaloko, provided historic sites are adequately protected (Hawaii County Department of Planning, 1983, p. X). Individual resort condominium developments are scattered along the coast.

During the 1970s, the resort construction boom made North Kona the island's fastest-growing district. In ten years, its population jumped 184 percent to a 1980 mark of 13,748, with the largest concentration (4,751) living in Kaiulua. (The Hawaii State Census Statistical Areas Committee estimates a January 1983 North Kona population of 16,266, which suggests slower growth during the less prosperous early 1980s.) Table 1-a also indicates a number of shifts in the district's demographic profile from 1970 to 1980. The Japanese proportion of the population declined particularly sharply in North Kona, and the ongoing in-migration of Caucasians from the Mainland made this district the only area on the island to have a Caucasian majority. Many of these in-migrants have been young to middle-aged adults, such that the median age remained near-constant while there were declines in the percentages of children and senior citizens. The prominence of Mainland in-migrants is also indicated by the high proportions of North Kona residents who had lived in a different state five years previously (23 percent, or twice the islandwide percentage) and who were born in the U.S. somewhere other than Hawaii (40 percent, again twice the islandwide percentage).

As shown in Table 1-b, North Kona residents in 1980 were slightly less likely than other Big Island residents to live in family households (reflecting the influx of young single people). The prosperity of the 1980 census year may be observed in the relatively high family median incomes, low poverty rate, and (Table 1-c) low overall unemployment rate. However, these figures were achieved only through active employment of most family members; North Kona's 72 percent labor force participation rate was the highest on the island. The occupational and industry profile for North Kona's labor force differed from islandwide figures in expectable ways: proportionately more people were engaged in a service occupation/industry or retail trade; fewer in agriculture, manufacturing, or professional activities. Housing costs were much higher in North Kona than elsewhere on the Big Island (Table 1-d), and proportionately more households were rented rather than owned.

The extent to which these trends will continue is a matter of some speculation. In-migration appears to have slowed in Kona, as it has statewide (Hawaii State Department of Planning and Economic Development, 1985b), in the wake of a national recession and consequent diminished tourism growth. However, population growth will probably continue to reflect economic opportunities, primarily in the visitor industry. From June 1980 to February 1985, the number of visitor-oriented hotel and condominium units in Kona (including a very few in South Kona) increased by nearly 1,000, and the 1985 Kona total of 4,748 represented 63 percent of the

island's visitor plant inventory. However, virtually all this growth was in condominium units; the number of hotel properties, which produce more direct per-unit employment, was unchanged in nearly five years (Hawaii Visitors Bureau, 1980, 1985). Even the future of resort condominium construction now appears more uncertain, given proposed changes in the Federal tax structure.

In the draft Kona Regional Plan, the Hawaii County Planning Department (1982, 1983) assumes there will be continued high growth rates in West Hawaii resort units and that tourism will continue to dominate the economy. However, the County does not make a definite forecast as to whether the growth will take place relatively more in Kona (the leader in the 1960s and 1970s) or in Kohala (the leader in the early 1980s—see below). Rather, the County makes three alternative projections for the year 2000:

—Alternative I assumes no further North Kona hotel construction and construction only of already-approved condominiums. This leads to a year 2000 figure of 2,940 "occupied" Kona resort units (no total-available unit count is given), and an estimated resident population of 33,200 for North and South Kona combined. (The County projections do not allocate the population to North or South Kona, but North Kona's historically faster growth rate would suggest that about three-quarters of the "combined Kona" population would be in North Kona.)

—Alternative II assumes complete development of the Keauhou Resort complex and some additional condominiums. The year 2000 figures are for 4,500 occupied units and 39,400 residents for the combined Kona areas.

—Alternative III assumes continuation of Kona's historical growth rates prior to the 1980s. This would result in 5,700 resort units in the year 2000, as well as an estimated 46,300 resident population for the combined Kona areas.

South Kona

As a secondary impact area, South Kona will be discussed more briefly. This district remains considerably more rural than North Kona, in part because growing conditions have been more favorable to agriculture. Its economy is based on scattered ranch and farming operations, retail activity in the small settlements, fishing, and nonresort operations catering to sight-seers (such as marine recreation at Kealekeua Bay or the City of Refuge National Park at Honaunau). Many residents

commute to jobs in North Kona hotels. Although no dollar figures are available, illicit marijuana growing is believed to be an important underground economic activity in both North and South Kona—but perhaps relatively more so in South Kona due to the lack of other economic opportunities.

Its 1980 population of 5,914 (including 3,041 concentrated in the principal communities of Captain Cook and Kealekua) represented a 48 percent increase over the 1970 population. This was about the same growth rate as that experienced by the island as a whole. The estimated January 1983 South Kona population was 6,457 (Hawaii State Census Statistical Areas Committee, 1984).

South Kona has experienced some of the Mainland in-migration also occurring in North Kona, but to a lesser extent. As shown in Table 1-a, the demographic changes which took place during the 1970s made South Kona's population more similar to the island wide population in 1980 than it had been before—particularly in regard to age structure, mobility, and ethnicity. Despite substantial increases in the Caucasian share of South Kona's population, the district in 1980 was still somewhat less "haole" (but more Hawaiian) than the Big Island as a whole. Trends, however, would suggest a continuing decline in the proportions of Japanese and Filipinos, two groups which tend to be aging on average. Average educational levels in South Kona improved only slightly from 1970 to 1980, dropping behind countywide standards.

Family structure and income patterns were essentially identical to islandwide ones in 1980 (Table 1-b). This indicates a substantial drop in poverty rates since 1970, although it is difficult to say whether this reflected greater prosperity for longtime residents or in-migration of more affluent people. South Kona's 1980 unemployment rate was lower than the islandwide one, and its labor force participation rate higher (Table 1-c). The 1980 labor force profile shows much higher proportions of workers involved in agriculture or fishing in South Kona than in either North Kona or the overall island, with service-worker percentages lower than in North Kona but higher than the county wide average. South Kona residents had to commute longer than North Kona workers to their jobs, suggesting substantial out-of-district employment.

Housing costs, particularly rents, were more affordable in South than in North Kona as of 1980, but there were fewer rental vacancies, more crowded households, and substantially more old structures lacking some or all plumbing (Table 1-d).

South Kohala

Until the mid-1960s, South Kohala's economy centered almost exclusively on ranching, particularly the sprawling Parker Ranch headquartered in the district's principal town of Waimea (also called Kamuela). In 1965, tourism began to bring economic prominence to the dry coastal regions with the opening of the 310-room Mauna Kea Beach Hotel. The 1970s saw construction of the Queen Kaahumanu highway to North Kona, development of the Lalamilo water system, expansion of the Waikoloa resort-residential subdi vision south of Waimea, and the establishment of numerous second homes and an observatory basecamp in Waimea itself.

The 1980s have brought new resort hotel operations to South Kohala even as hotel growth has stagnated in North Kona. The 543-room Sheraton Royal Waikoloa opened in 1981; the 351-room luxury Mauna Lani Bay Hotel started operations in 1983; and the government approval process appears well underway for another 350-room hotel near the Mauna Kea and a 1,250-room "Disneyland-style" Hyatt hotel at Waikoloa. There are plans or proposals for another 3,266 hotel and 4,389 condominium units on the Kohala coast (possibly including portions of North Kohala) (Hawaii Visitors Bureau, 1985), more than twice the number of contemplated additional North Kona units. The County's draft Kona Regional Plan projects a total of 10,500 "occupied" resort units in Kona and Kohala combined by the year 2000. For the three previously-listed alternative futures for Kona, it is assumed that new units not built in Kona would go in Kohala.

As shown in Table 1-a, South Kohala's population doubled from 2,300 in 1970 to 4,600 in 1980, with most of that growth in or around either Waimea or Waikoloa. The estimated January 1983 population was 5,271 (Hawaii State Census Statistical Areas Committee, 1984). South Kohala has historically been largely Caucasian and Hawaiian, and it grew even more so during the 1970s. Other changes attributable largely to recent in-migration include a sharp jump in average educational levels and higher proportions of people either born on the Mainland or living there five years previously than was the case islandwide.

Family structure in South Kohala roughly paralleled islandwide figures in 1980 (Table 1-b), although there were proportionately slightly more single parents and especially single mothers. Median family income was lower than the islandwide figure but so was the family poverty rate, suggesting less income spread among South Kohala residents. Unemployment and labor force participation rates fell in between the islandwide and Kona figures (Table 1-c). The 1980 worker profile was more similar to that of South than of North Kona, albeit with more managerial/professional

people. Employee commuting to North Kona hotels that year is suggested both by the worker profile and the long average commute time. South Kohala housing was more expensive than islandwide averages (Table 1-d), but not as expensive as in North Kona. The overall quality of housing structures appears better in South Kohala than in either North or South Kona.

POTENTIAL SOCIO-ECONOMIC IMPACTS AND MITIGATING MEASURES

Introductory Comments

The potential growth impacts of expanding the NELH and developing the HOST Park are summarized in Tables 2-a through 2-d. The impacts are developed for the three previously described growth scenarios for HOST:

- A: Maximum aquaculture and ocean-related uses, with minimum acreage for campus/industrial activities.
- B: Moderate aquaculture and ocean-related uses, with moderate acreage for campus/industrial activities.
- C: Minimum aquaculture and ocean-related uses, with maximum acreage for campus/industrial activities.

The alternative development scenarios for NELH are not analyzed separately because the range of potential impacts for NELH is comparatively small. Instead, the NELH scenario which is used in estimating potential growth impacts is the one that gives the maximum impact, namely, the Aquaculture Intensive Scenario; aquaculture requires more workers per acre than is the case for solar ponds.

The impacts covered include direct and indirect construction and operating employment for West Hawaii and Statewide, household income, population, and housing.

The potential growth impacts should not be interpreted as projections of what is most likely or expected to occur. Instead, the impacts shown in Tables 2-a through 2-d reflect maximum potential impacts given the assumption of full and intensive development of both NELH and HOST within 10 years. In all probability, the actual impacts will be less than that which is shown in the tables. The unique combination of cold, nutrient-rich and pathogen-free deep ocean water, warm ocean water, high solar radiation, access to overseas markets, and recent aquaculture successes argues very favorably for future aquaculture development. Nevertheless, market and feasibility studies have not been conducted which would allow informed judgments about the size of the market, and the rate and intensity of development. The market for high-technology activities which would occupy the remaining portion of the HOST

park is even more uncertain. In addition, many of the conversion factors used to develop employment, income, population, and housing impacts are judgments based on similar activities.

Acreage Assumptions

The principal growth assumptions for the three scenarios are acreage allotments among various activities as shown in Table 2-a. For HOST, the scenarios differ according to the allocation of land between building/support services and aquaculture and other ocean-water activities. For NEHL, the scenarios differ according to the allocation of land between commercial aquaculture and solar ponds. However, as previously mentioned, the impacts for the NEHL are developed assuming maximum aquaculture and minimum solar-pond acreage.

Average Annual Construction Employment and Income

Assuming that both NELH and HOST can, in fact, be developed fully over 10 years, then average construction employment will average about 73 to 150 jobs, depending on whether the development is based more on aquaculture or buildings/support activities (see Table 2-b). Direct plus indirect employment would average about 183 to 375 jobs, with about 88 to 180 jobs in West Hawaii. Because of uneven development over time, actual employment can be expected to deviate greatly from average employment.

Since the construction industry is expected to grow only modestly over the next decade, most construction workers probably would be hired locally or employed on temporary assignment from Oahu or possibly Maui. The indirect jobs would be distributed throughout the economy with most located in Honolulu, which is the government, service, and distribution center for the State.

Salary levels for both the direct construction jobs and the indirect jobs are higher than the Statewide average of about \$16,880. Under the given assumptions, total household income generated by construction would average \$4.3 to \$8.9 million per year.

Operating Employment and Income Impacts

Assuming full and intensive development of NELH and HOST, onsite employment will total 1,590 to 3,580 (see Table 2-b). Lower employment will occur with greater aquaculture development since fewer jobs per acre are generated than is the

case with buildings. Employment may even be less if low-intensity aquaculture were to develop. It is assumed that about 25 percent of the onsite jobs will be skilled and professional, 40 percent will be semi-skilled, and 35 percent will be unskilled.

Inasmuch as some of the indirect support jobs generated by aquaculture can be expected to locate in HOST, direct employment is expected to be somewhat less than total onsite employment.

The corresponding amount of total direct plus indirect employment is estimated to be 2,520 to 4,060 jobs, with 1,780 to 4,200 located in West Hawaii, and 740 to 1,750 located elsewhere. The indirect jobs would be distributed throughout the economy with most located in Honolulu which, as mentioned previously, is the government, service, and distribution center for the State.

Salary levels for semi-skilled, skilled, and professional workers can be expected to be above average, with unskilled workers having below-average wages. For indirect jobs, the annual salary is assumed to equal the State average. Under the given assumptions, total household income during full operations would average \$48.7 to \$114.4 million per year.

In addition to increased employment and income, expansion of NELH and the development of HOST will contribute to a more diversified and stronger economy for West Hawaii, Hawaii County, and the State.

Training and Education to Maximize Resident Employment

Given high Big Island unemployment rates, the State and (particularly) County governments have expressed concern that any economic development projects initiated in West Hawaii lead to as much employment as possible going to longtime residents. There are three categories of workers who might be viewed as labor market "competition" for longtime West Hawaii residents:

- (1) Mainland or foreign workers imported to fill a job as it is being created. It is expected that many of the top management and professional-level personnel will be imported as companies initiate operations at NELH or HOST Park, but there is also a hope that qualified local residents can be hired for such positions (and/or be started on a career ladder toward them) as time goes on.
- (2) Recent in-migrants who are seeking work after having already arrived in Kona.

The North Kona area is characterized by a high number of young transients who are seeking opportunities to remain. Employment for such

individuals serves a number of social and economic objectives, but local government has generally placed an even higher priority on assuring employment for longtime residents with deeper family roots.

- (3) Potential in-migrants from East Hawaii or other Hawaiian islands. In-migration of any large groups of people not already housed in West Hawaii would create additional demand for housing and public services. On the other hand, the islandwide economic situation makes it both likely and to some extent desirable that any new West Hawaii employment opportunities will attract people from East Hawaii or (especially at upper levels) from other Hawaiian islands.

Thus, the primary objective is to maximize employment for longtime West Hawaii residents, with secondary consideration for needy longtime residents of other Hawaii areas. Mandatory local-hiring requirements for commercial tenants would not be feasible or desirable, and so the principal methods for attaining this objective would involve training and education—including in-service upgrade—to increase the competitiveness of longtime residents. Supporting strategies might include community awareness efforts and employer incentive programs.

A number of factors define the situation and/or place constraints on the possible actions which could be taken:

—The ultimate nature and number of jobs is not yet clear. Timing of job creation is also uncertain, but it appears most likely that employment opportunities will come on-line in trickles rather than in the large clusters of jobs characterizing, for example, hotel start-ups.

—For lower-level jobs, aquaculture employers indicate that their hiring criteria have less to do with specific skills or training than with ". . . good attitude, willingness to do tedious and unchallenging tasks, hard manual labor and the ability to learn and follow instructions well. Workers do not need a college degree; they will learn the required skills while on the job" (Dung and Wakui, 1980, p. 12).

While this applies to aquaculture, it may be expected that personnel offices for other potential NELH/HOST Park industries will also place more emphasis on general motivation and competence than on specific pre-employment training when selecting entry-level employees.

—At the mid level, promotions to the supervisory level in aquaculture—and in many other high-tech industries—are often based more on abilities in "people management" than on technical knowledge which could be gained

through formal education. (For aquaculture, the other type of mid-level job has to do with mechanical maintenance, and these skills are more amenable to formal training, although this is often acquired through trade apprenticeship than classroom situations.)

—Upper-level high-tech jobs require college and often post-graduate degrees. There is no college in West Hawaii, and even the University of Hawaii at Hilo offers no post-graduate degree.

—In some respects, West Hawaii's transient population is more competitive for lower-level jobs. They often have better communication skills (useful in making good first impressions), a high level of education, and a willingness to work for lower wages because they do not anticipate making a lifetime career in Hawaii. In other respects, they are less desirable to those experienced employers who understand that turnover will be high among such people.

—Aquaculture operators in Hawaii to date have generally established a good record for local hiring. At the same time, entrepreneurs in high-tech research and development industries are often highly individualistic and independent. They are likely to reject strategies to maximize local employment if these strategies involve much "red tape" or pressure to hire less qualified people.

—Because this project would lease to numerous independent employers, any effective program to maximize local employment would require a central office or body to serve as liaison between employers and labor supply sources. A management strategy for the HOST Park has not yet been finalized, and it is not yet known if or when NELH and the HOST Park will be consolidated under a single management. However, a HOST Park Tenants' Association will probably be created.

—There are numerous resources for helping obtain and/or train local labor, but there is no standing network to ensure their coordination or communication. Following is a brief inventory—not intended to be exhaustive—of resources which might be linked together in the future:

- State Department of Labor and Industrial Relations: The DLIR's Employment Service Division is Hawaii's principal clearinghouse for currently unemployed labor. It usually offers federally-funded programs to help place and train economically disadvantaged workers. Presently, the main such program is the Jobs Training Partner-

ship Act (JTPA), which pays 50 percent of eligible workers' starting salaries during the training period.

Additionally, DLIR's Office of Employment and Training Administration has in the past operated limited aquaculture training programs on Oahu, Maui, and Kauai.

- Native Hawaiian Economic Development Organizations: Alu Like, Office of Hawaiian Affairs, and Kamehameha Schools are among the agencies working to improve the economic competitiveness of native Hawaiians. Alu Like and the Kamehameha Schools are presently developing a new vocational training program which might represent one vehicle for preparing Big Island Hawaiians for mid-level jobs involving skills such as mechanical maintenance. Kamehameha Schools has packaged basic education courses which include attention to things such as attitude and motivation. Alu Like also functions as an employment service and could screen job applicants.

- Liliuokalani Trust Aquaculture Facilities: The Liliuokalani Trust, established to enhance the social welfare of native Hawaiian children, has constructed a number of traditional aquaculture facilities (ponds, tanks, raceways, etc.) between Ke-ahole and Kailua. It is to be a research and development effort to determine how and under what conditions aquaculture can be successful for a social agency, and to give Hawaiian children a sense of self-sufficiency through participation in the planning and implementation of such a project. From the NELH/HOST perspective, the facility offers a chance to familiarize local children with aquaculture concepts and give them early hands-on experience.

- Local Community Groups and News Media: To develop widespread local awareness of, and interest in, project employment opportunities, adults as well as children must be kept informed of the project. The NELH's community tours have provided an excellent initial step.
- Unions: It is not currently known whether or how many of the potential commercial tenants will be unionized. At present, only one aquaculture operator in Hawaii (on Oahu) is unionized. If labor unions become involved to a significant extent at the Ke-ahole projects, they might participate in manpower training plans, particularly those involving upgrade training.

o State Department of Education: If it becomes apparent there will be significant labor needs in a particular industry, vocational education programs in area schools can be tailored to develop appropriate skills. High school counselors can assist in placing entry-level workers at the project, and science class field trips to NELH/HOST would increase local resident awareness of, and interest in, these job opportunities. There is also the potential for establishing college scholarship programs through the schools to help educate future marine biologists, genetic scientists, etc. While the Kona waena High School would be the principal contact, any network of resources should also include Kona elementary schools and high schools throughout the island (including private schools).

The DOE's Development Services and Continuing Education Branch, which administers adult education classes, might also be involved if a widespread need for basic education becomes apparent among adult community job applicants.

o Community Colleges: The community college system of the University of Hawaii would be a prime resource for training technicians at the level of Associate of Sciences degree or below. The system can provide specialized short-term training or retraining programs on a contractual basis through its Employment and Training Office (ETO). Additionally, normal class offerings provide vehicles for both general workforce education and specific in-service upgrade training efforts. The community college Chancellor is a member of the High Technology Development Corporation's education advisory committee.

The Big Island's sole community college is the Hawaii Community College (HCC), located in Hilo. HCC has offered an introductory aquaculture course which has, to date, concentrated on providing practical information for individuals interested in setting up their own small traditional aquaculture businesses. In 1982, HCC established a West Hawaii extension office (now headquartered in Kainaliu, North Kona) which may someday provide the basis for an independent community college and/or comprehensive technical training. At the present time, however, its course offerings are confined to liberal arts, accounting, clerical studies, and secretarial

science. Some Waimea residents are now exploring the feasibility of a privately-operated community college in South Kohala, and this could conceivably provide another West Hawaii resource for NELH/HOST in the future.

o University of Hawaii at Hilo: UH Hilo provides under graduate education, and it could play a role in both preparatory education and in-service upgrade training for mid-level and lower professional/managerial personnel. Its College of Agriculture has in the past offered a survey course on aquaculture science. In the future, it will be developing its own aquaculture facilities at the UH Hilo Agricultural Farm Laboratory in Panaewa, and the Academic Development Plan calls for creating an optional "specialization" in aquaculture as part of a Bachelor of Science course of studies in Agriculture. Implementation of these plans depends on legislative appropriations, although start-up is anticipated sometime in the late 1980s (Dean Jack Fujii, UH Hilo College of Agriculture, personal communication, June 1985).

Also headquartered at UH Hilo is the self-supporting Center for Continuing Education and Community Service (CCECS), which provides outreach services in other parts of the Big Island. CCECS established a Kona office in 1976, and this is currently operating on a joint basis with the HCC extension in Kainaliu.

o University of Hawaii at Manoa: UH Manoa will remain the state's primary educational resource for the sort of post-graduate degree work required for upper-level positions at NELH or HOST Park operations. Key departments there may include Botany, Zoology, the College of Tropical Agriculture and Resource Economics, College of Business Administration, Biology, Oceanography, and various special programs such as the Hawaii Institute of Geophysics, Hawaii Institute of Marine Biology, Hawaii Natural Energy Institute, the Marine Option Program, and the Pacific International Center for High Technology Research. It is to be expected that such programs will desire of their own accord to maintain contacts with the Ke-ahole facilities for purposes of both research and to help place their graduates. A more challenging task will be determining the feasibility of, and strategies for, the direction of promising

longtime Big Island residents into such programs with the expectation that some will return to assume very top positions at HOST or NELH.

- World Center for Aquaculture Research, Training, Education, and Consulting: The Governor's Aquaculture Industry Development Committee has proposed creation of at least a feasibility study of such a Center (State of Hawaii, 1984, pp. 20-21). At present, this is simply a conceptual proposal, but any action to implement it would obviously be of import for a training program to serve NELH/HOST.

From the foregoing discussion, it may be concluded that (a) there are a variety of existing resources to help attain the objective of maximizing longtime resident employment; (b) a conscious and deliberate effort will be needed to establish an effective network among these resources and NELH/HOST employers; (c) it makes little sense to make such an effort until more is known about the exact nature, number, and timing of jobs at Ke-ahole, as well as management structures; but (d) without some early commitment and preparation, the odds will be greater that the objective will slip in priority.

Therefore, the recommended actions at this time include:

- (1) The various affected branches of DPED should agree on a conceptual basis to develop a local job maximization program, including such components as:

- community outreach to stimulate awareness and interest, especially among young people;
- establishment of an advisory committee or some other structure to assure linkages with the earlier-mentioned resources;
- use of these linkages to solicit and screen job applicants for NELH/HOST employers, and to encourage development of needed educational programs which are identified as necessary for improving the competitiveness of longtime residents for jobs;
- internships or summer job programs for young people;
- facilitating in-service upgrade training programs of benefit to several different commercial tenants;
- efforts—perhaps involving coordination of tenant contributions toward a scholarship fund—to encourage and guide capable young residents to educations preparing them for ultimate promotion to top professional and management jobs.

- (2) This agreement should also include a commitment to provide appropriate funding and staff—at least one full-time position when the number of tenants justifies it—to carry out such a program. It is not known at this time whether the funding and staff would most appropriately go to State administrators or to a future tenants' association.
- (3) As an early step toward carrying out the agreement, a conference should be held within the first year after the opening of the HOST Park to help establish linkages and begin to formulate a more specific plan. Conferees should include appropriate resource agencies; tenants and potential tenants; and NELH/HOST administrators. The conference might also include other Big Island scientific and technical employers, such as astronomy research operations. It is unlikely that this early gathering would produce an exact plan for implementation, but it should result in an overall strategy and timetable for developing the program.

- (4) No legal requirements for local hiring could or should be imposed on tenants, but they should be made aware of the State commitment. The suggested early conference might focus in part on prospective employers' reactions to possible incentives for participating in a centralized program for job recruitment and screening, in-service upgrade training, scholarships, etc. Some incentives meriting consideration would include excise tax breaks, lease rate reductions, and relieving employers of paperwork burdens for programs such as JTPA.

While the uncertainties of the project tend to prohibit anything but a moral commitment at this point, it is important that the commitment be voiced publicly and contain as many specifics as the situation permits.

Maximization of Local Resident Access to Leases

Given the technology-intensive nature of the NELH/HOST projects, most businesses in the initial stages will probably be attracted from outside Hawaii. However, it is important for Hawaii residents to have access to Ke-ahole's unique resources, whether for entrepreneurial or for nonprofit community activities. Several actions are suggested:

- (1) Small parcels of land should be set aside at NELH for experimental or educational projects of nonprofit community groups. Normal lease rentals and compliance with safety and design standards would be required, but application procedures should be greatly simplified and parcel acreage be

kept small to minimize rents. NELH are currently working on a plan to accomplish this.

- (2) The previously-recommended program to maximize local employment benefits should also include an entrepreneurial component. At a minimum, this would involve information and referrals. At a maximum, it could facilitate periodic well-publicized visits by agencies providing technical and/or financial assistance—e.g., the Honolulu-based Hawaii Entrepreneurship Training and Development Institute, currently the management and technical assistance contractors for the SBA, which provides free consultation and loan packaging services for new businesses headed by eligible socially or economically disadvantaged owners.

Population

Full and intensive development of NELH and HOST would support about 5,040 to 11,900 people in Hawaii, with 3,560 to 8,400 in West Hawaii and 1,480 to 3,500 elsewhere (see Table 2-d).

Even though companies at NELH and HOST can be expected to hire a number of people locally, the increased employment opportunities in West Hawaii will contribute to net immigration, since tourism development is expected to cause West Hawaii to be a labor-short area. If a local resident obtains a job at NELH or HOST rather than one in the visitor industry, then that job in the visitor industry is available to workers from outside the region. Similarly, if a local resident obtains a job at NELH or HOST rather than moving off-island, then out migrations is reduced. In either case, the result is an increase in net immigration. Given the above population supported by NELH and HOST and assuming a rapid 10-year development period, then the increase in the West Hawaii population contributed by the two developments will average about 356 to 840 people per year.

As with most new people moving into an area, the added population can be expected to be younger (20 to 30 years of age), to have more education, and to be more mobile than average. Furthermore, most will be single, and either from Oahu or the mainland.

Housing

Corresponding to the population increase, the two developments will provide support for 1,680 to 3,970 homes Statewide, with 1,190 to 2,800 homes in West Hawaii, and 490 to 1,170 homes elsewhere (see Table 2-d). For West Hawaii, the

increase would average about 119 to 280 homes per year, assuming full and intensive development within a 10-year period. For comparison, the average increase in housing units during the 1970s for North Kona and all of West Hawaii (North Kona, South Kona, and South Kohala) averaged 492 and 700 per year, respectively. Focusing only on units occupied year-round by residents (and eliminating second homes and units available to the visitor market), the average increase for Kona and West Hawaii was 317 and 480 per year, respectively.

Community surveys conducted in 1976 and 1980 indicated that housing is a major concern with West Hawaii residents (County of Hawaii, Kona Regional Plan, 1982). The principal issue has been the high price of housing and problems of affordability. During the late 1970s, housing prices in Kona increased rapidly, resulting in average home prices that were much higher than in Hilo and other areas of the Big Island. These price increases far outstripped reported family income, which is a particular concern given that the economic and population growth in Kona was driven by growth of the low-paying visitor industry. Also, the waiting list for homes offered by the Hawaii Housing Authority (HHA) was long, and a large number of homes were thought to be dilapidated based on the fact that many are over 50 years old.

For perspective, however, the following should be noted:

- High housing prices are correlated with healthy, growing economies, while low housing prices are correlated with unhealthy, declining economies.
- The rapid growth in housing prices in the late 1970s was part of a nationwide short-term upswing in the real estate price cycle.
- Even though housing prices increased greatly during the 1970s, housing in Kona improved in terms of a higher percentage of residents owning their own homes, fewer units lacking some or all plumbing, and less crowding (see Table 1-d).
- The extent to which the long waiting list for HHA homes indicated housing problems rather than housing bargains is unclear.
- The number of homes 50 years old or older that are dilapidated rather than old but well maintained is unknown.
- Some retirees may report low incomes, but may be able to afford relatively expensive homes because of accumulated wealth and/or unreported tax-exempt income.
- Some workers in the visitor industry thought to have severe affordability problems actually do not, inasmuch as over 25 percent of the workers in the visitor industry receive tip income, and this income can be very

substantial (e.g., waiters and waitresses in popular restaurants have been found to earn 3.5 times their reported income).

—The majority of workers who are dependent indirectly upon the visitor industry probably do not have severe affordability problems since most of these workers have higher than average incomes; their problems of affordability are probably similar to most other middle-income families in the State who live in an area having a healthy economy and relatively high housing prices.

—Some of the people holding lower paying jobs in the visitor and other industries are, in effect, on extended working vacations in Hawaii, and do not require high-quality permanent housing; the number of such workers appears to increase during periods of rapid expansion of the visitor industry.

—Some of the condominium units intended for but not rented to visitors have been made available to residents at bargain rental rates, considering the amenities provided; however, the number of such units made available to residents decreases during boom periods when additional housing is needed most.

—Since 1980, housing affordability has improved greatly; mortgage rates have dropped substantially and, as measured in constant dollars, single-family housing prices in Kona have dropped 38 percent (Locations, Inc., Hawaii Real Estate Indicators, April 1985). But similar to the increase in real estate prices in the late 1970s, the recent decline in housing prices has been part of nationwide short-term down-swing in the real estate cycle. And even with lower mortgage rates and housing prices, problems of housing affordability still remain.

Regarding the future, however, West Hawaii is expected to have higher housing prices and increased problems of affordability. This can be expected throughout Hawaii County, the State, and the nation as a result of a nationwide upswing of the real estate cycle. In addition, West Hawaii is expected to experience large jumps in construction and visitor-industry employment along with large jumps in housing demand as a result of developing or expanding the Hyatt, Mauna Kea, Kona Village, Mauna Lani and other resorts and hotels.

However, the contribution of the NELH and HOST projects to high housing prices in West Hawaii is expected to be comparatively modest since expansion is expected to be relatively gradual, and the bulk of the housing demand will be

generated by growth in the visitor industry (over 825 residential units per year for Kona and Kohala; County of Hawaii, Kona Regional Plan, 1982). Furthermore, workers directly and indirectly dependent upon the NELH and HOST projects should be better able to afford housing in West Hawaii than those dependent on the visitor industry since, on average, those dependent on the NELH and HOST will have higher wages.

Nevertheless, a portion of the NELH and HOST workers will encounter problems of housing affordability. Mitigating measures designed to moderate the general increase in housing prices, many of which are given in the Kona Regional Plan, include:

- Increase the supply of developable land by liberal State districting and County zoning, and government development of roads, water, sewers, etc.
- Increase the supply of affordable housing by reducing lot sizes and allowing increased densities, thereby reducing the amount of land required for each home.
- Decrease construction costs by relaxing requirements for off-site and on-site improvements, allowing manufactured housing, and simplifying and shortening the permit approval process.

Mitigating measures designed to assist qualifying low- and moderate-income households include:

- Provide direct income supplements, including: (1) rent subsidies administered by the HHA; (2) mortgage supplements under the State Hula Mae Special Assistance Program; (3) and general financial assistance under a variety of programs administered by the Hawaii Department of Social Services and Housing.
- Provide low-interest mortgages to first-time home buyers financed with tax-exempt State and/or County revenue bonds.
- Exempt County property taxes.
- Provide, under the State Housing Program, State land and/or housing at below market rents or prices.
- Provide low-interest rehabilitation loans to correct deteriorated and hazardous conditions.

Total Population and Demographic Breakdowns: State of Hawaii, County of Hawaii, and Possible Affected Areas, 1970 and 1980

	STATE OF HAWAII		COUNTY OF HAWAII		NORTH KONA (C.T. 215-216)		SOUTH KONA (C.T. 215-214)		SOUTH KOHALA (C.T. 217)	
	1970	1980	1970	1980	1970	1980	1970	1980	1970	1980
TOTAL POPULATION	769,911	904,621	67,968	72,037	14,022	17,728	14,004	17,714	2,310	4,607
ETHNICITY										
Caucasian	38.8	34.4	28.8	35.0	44.0	53.8	17.7	30.0	39.2	46.5
Japanese	28.3	24.9	37.5	26.6	23.1	11.8	39.6	27.5	24.4	14.6
Chinese	6.8	5.8	2.9	1.7	3.7	1.6	0.8	0.8	1.3	1.4
Filipino	12.2	10.7	16.5	17.9	8.4	7.2	26.2	13.0	6.6	3.6
Hawaiian	9.3	12.3	12.3	18.8	19.3	22.1	14.7	23.5	26.4	28.5
Other	4.6	9.0	2.0	4.1	1.5	3.5	1.0	5.2	2.0	3.4
AGE										
Less than 5 yr.	7.2	8.1	8.6	9.1	9.1	9.1	9.0	9.8	9.3	10.2
5 - 17 yr.	26.6	20.5	27.8	21.5	27.0	20.5	29.8	20.7	28.2	22.6
18 - 64 yr.	58.5	62.5	54.4	59.2	55.7	62.9	48.9	58.8	56.1	59.6
65 or more yr.	5.8	7.9	9.2	10.2	8.2	6.7	12.4	10.6	6.4	7.7
Median age	25.0 yr	28.4 yr	28.9 yr	29.4 yr	28.6 yr	28.9 yr	29.7 yr	29.7 yr	28.1 yr	29.3 yr
PLACE OF BIRTH										
Hawaii	NC	57.8	NC	70.5	NC	54.4	NC	71.2	NC	64.9
Other U.S.**	NC	28.0	NC	20.0	NC	19.9	NC	20.8	NC	20.4
Foreign country	NC	14.2	NC	9.4	NC	5.7	NC	7.9	NC	4.7
RESIDENCE 5 YRS. PREVIOUS										
(people aged 5+)										
Same house	46.0	49.0	62.5	52.9	51.1	38.8	56.1	57.4	45.6	50.7
Same island	NC	25.2	NC	24.9	NC	28.1	NC	22.9	NC	17.3
Different island	NC	2.8	NC	8.1	NC	7.0	NC	6.5	NC	14.9
Different state	NC	16.9	NC	11.1	NC	22.1	NC	10.7	NC	16.4
Different country	NC	5.9	NC	3.1	NC	3.0	NC	1.2	NC	0.7
EDUCATION* (selected) - people aged 25+										
0-8 years only	24.8	16.2	37.2	20.1	28.9	8.0	26.1	23.6	24.1	8.6
Hi school only	35.9	35.1	31.6	35.3	66.0	41.9	21.9	33.8	34.2	27.0
College, 4+ yr.	14.0	20.7	7.5	15.2	8.8	18.8	6.4	12.4	13.1	20.7

Notes: *Figures based on 15% sample; hence, numbers represent estimate.
 **Including persons born in U.S. territories, and persons born abroad or at sea to American parent/s.
 "NC" = 1970 categories or bases "Not Comparable" to 1980 (1970 Census kept a "non-response" category, while 1980 Census allocated non-responses to other categories shown).

Sources: U.S. Bureau of the Census, 1970 Census of Population and Housing--Census Tracts--Honolulu, Hawaii, PHC(1)-88; 1980 Summary Tape Files 1-A and 2-A; State of Hawaii, 1975, Community Profiles for Hawaii.

TABLE 1-a

22

Family Characteristics and Income Levels: State of Hawaii, County of Hawaii, and Possible Affected Areas

	STATE OF HAWAII		COUNTY OF HAWAII		NORTH KONA (C.T. 215-216)		SOUTH KONA (C.T. 215-214)		SOUTH KOHALA (C.T. 217)	
	1970	1980	1970	1980	1970	1980	1970	1980	1970	1980
POPULATION IN FAMILIES	N/A	831,810	N/A	81,728	N/A	11,543	N/A	5,235	N/A	4,114
as percentage of total population	N/A	86.2%	N/A	88.8%	N/A	84.0%	N/A	88.5%	N/A	89.2%
NUMBER OF FAMILIES	179,338	227,974	14,022	22,825	1,131	1,329	848	1,378	533	1,204
HEAD										
husband/wife	80.8	82.9	87.1	82.1	87.4	84.0	88.7	83.4	80.1	79.7
Male only	2.9	4.6	5.2	5.2	4.1	4.7	4.8	6.1	3.6	7.6
Female only	9.3	12.5	7.7	12.7	3.5	11.4	7.3	10.5	6.4	12.7
WITH OWN CHILDREN UNDER 18										
Female head	62.1	54.4	57.4	52.7	52.4	54.4	59.7	51.5	63.2	51.6
Male head	5.8	7.4	4.9	7.4	5.0	4.8	3.5	5.4	4.5	9.1
BELOW POVERTY LEVEL	7.7	7.8	9.7	10.2	12.0	8.0	17.3	9.8	11.8	5.7
MEDIAN FAMILY INCOME	\$11,554	\$22,750	\$9,750	\$19,100	\$9,000 to \$9,999	\$21,100	\$10,000 to \$11,999	\$19,128	\$9,182	\$17,924

Notes: All figures (except "Population in Families") based on 15% sample; hence, numbers represent estimates.
 "N/A" = "Not Available" in published form. However, other published 1970 and 1980 census data lead to the conclusion that families generally comprised a smaller percentage of Hawaii's 1970 population than of the 1980 total.

Sources: U.S. Bureau of the Census, 1970 Census of Population and Housing--Census Tracts--Honolulu, Hawaii, PHC(1)-88; 1980 Summary Tape File 2-A; State of Hawaii, 1975, Community Profiles for Hawaii.

TABLE 1-b

23

Labor Force Size and Characteristics: State of Hawaii, County of Hawaii, and Possible Affected Areas, 1970 and 1980

	STATE OF HAWAII		COUNTY OF HAWAII		NORTH KOHA (C.T. 215-216)		SOUTH KOHA (C.T. 213-214)		SOUTH KOHALA (C.T. 217)	
	1970	1980	1970	1980	1970	1980	1970	1980	1970	1980
POTENTIAL LABOR FORCE										
aged 16+	522,018	723,479	43,075	67,205	3,632	10,115	2,629	4,265	1,446	3,290
not in labor force	34.1%	21.7%	29.5%	20.2%	44.7%	27.6%	41.6%	25.0%	24.2%	25.9%
armed forces	9.5	6.1	6.4	0.0	0.0	0.1	0.0	0.0	0.0	0.0
civilian labor force	56.4	69.2	29.1	47.0	55.7	72.1	58.4	66.2	65.8	64.1
CIVILIAN LABOR FORCE										
employed	294,484	435,780	25,889	41,006	2,022	7,293	1,535	2,823	951	2,110
unemployed	3.0%	4.7%	1.7%	3.0%	3.6%	5.2%	3.9%	5.7%	4.1%	6.3%
TOTAL EMPLOYED CIVILIAN LABOR FORCE	285,556	415,181	25,180	38,150	1,925	6,913	1,500	2,662	912	1,978
OCCUPATION										
service	15.4	17.5	14.2	16.1	15.7	21.2	16.0	17.3	15.9	18.0
manager, profes.	NC	22.5	NC	20.0	NC	22.2	NC	22.6	NC	20.6
technical, sales	NC	11.0	NC	10.1	NC	28.1	NC	24.8	NC	15.2
admin.	NC	7.6	NC	15.7	NC	7.1	NC	19.5	NC	14.0
operator, fabric.	NC	11.6	NC	12.7	NC	12.1	NC	14.8	NC	16.5
operator, teachers	NC	11.7	NC	14.4	NC	9.9	NC	10.0	NC	11.8
INDUSTRY (1980)										
agricult. forest.										
mining	4.2%	3.6%	12.5%	11.2%	N/A	2.0%	N/A	19.4%	N/A	19.8%
construction	6.7%	5.2%	11.8%	9.2%	22.6%	11.2%	20.4%	14.2%	17.6%	12.3%
manufacturing	10.9	7.9	15.0	8.2	1.0	1.9	3.2	1.2	2.7	5.1
retail trade	12.4	12.9	14.8	17.5	17.1	27.6	8.9	18.4	15.9	15.8
financial, insur.,										
real estate	5.0	2.6	2.5	5.7	4.0	6.6	3.5	4.5	3.5	7.6
personal, entertain.										
recreat. services	8.5	9.2	11.2	10.9	N/A	20.7	N/A	15.2	N/A	16.0
health, educ., s.										
professional	17.2	17.7	14.1	16.7	7.8	11.4	16.7	13.1	13.9	14.8
public admin.	11.4	10.0	6.5	7.2	4.2	2.7	3.7	4.8	3.1	2.1
COMMUTE TO WORK										
45 minutes or more	N/A	12.5%	N/A	6.0%	N/A	4.8%	N/A	6.8%	N/A	12.9%
mean travel (min.)	N/A	21.5 m	N/A	16.5 m	N/A	18.4 m	N/A	20.6 m	N/A	21.7 m

Notes: All figures based on 15% sample; hence, numbers represent estimates.
 "N/A" = "Not Available" or unpublished item. "NC" = 1970 categories or bases "Not Comparable" to 1980 Census.
 Sources: U.S. Bureau of the Census, 1970 Census of Population and Housing; Census Tracts--Honolulu, Hawaii, PHC(1)-80; 1980 Summary Tape File 1-A; State of Hawaii, 1977, Community Profiles for Hawaii.

TABLE 1-C

24

Housing Stock and Characteristics: State of Hawaii, County of Hawaii, and Possible Affected Areas, 1970 and 1980

	STATE OF HAWAII		COUNTY OF HAWAII		NORTH KOHA (C.T. 215-216)		SOUTH KOHA (C.T. 213-214)		SOUTH KOHALA (C.T. 217)	
	1970	1980	1970	1980	1970	1980	1970	1980	1970	1980
TOTAL YEAR-ROUND HOUSING UNITS	215,892	332,213	18,939	33,954	1,975	6,894	1,131	2,052	798	1,939
vacant (total)	5.9%	11.5%	9.0%	15.9%	27.4%	33.3%	6.4%	9.7%	18.5%	24.3%
vacant for sale	0.6	0.6	0.6	1.3	3.2	3.2	0.0	2.9	0.1	2.9
vacant for rent	2.5	4.9	2.0	5.5	6.5	18.9	0.3	2.1	1.9	4.1
TOTAL YEAR-ROUND OCCUPIED UNITS	203,088	294,052	17,260	29,237	1,431	4,602	1,059	1,653	650	1,483
TENURE										
owner-occupied	46.9%	51.7%	56.9%	60.6%	44.7%	55.1%	36.9%	52.7%	48.8%	59.3%
renter-occupied	53.1	48.3	43.1	39.4	55.3	44.9	63.1	47.3	51.2	40.7
SELECTED CONDITIONS										
lacking some or all plumbing	5.6%	2.2%	17.1%	6.4%	26.3%	7.3%	55.8%	28.4%	15.4%	2.0%
1.51 or more persons/room	7.8	7.0	6.5	5.0	14.1	6.1	13.1	10.1	8.2	5.3
PERSONS PER HOUSEHOLD	3.59	3.15	3.61	3.09	3.26	2.92	3.71	3.14	3.51	3.07
MEDIAN CASH RENT										
owner-occupied	\$121	\$273	\$54	\$223	\$150 to \$199	\$331	\$60 to \$79	\$200	\$116	\$307
MEDIAN VALUES										
owner-occupied	\$35,200	\$119,400	\$24,800	\$70,300	\$35,000 to \$49,999	\$114,000	\$35,000 to \$49,999	\$102,600	\$31,800	\$95,700

Notes: * For 1980, median values are for owner-occupied housing units.
 Sources: U.S. Bureau of the Census, 1970 Census of Population and Housing; Census Tracts--Honolulu, Hawaii, PHC(1)-80; 1980 Summary Tape File 1-A; State of Hawaii, 1973, Community Profiles for Hawaii.

TABLE 1-D

25

Table 2-a.— POTENTIAL SOCIO-ECONOMIC IMPACTS:
Acreage Assumptions

Item	HOST Scenario for Pond Area		
	A Maximum	B Medium	C Minimum
HOST:			
Commercial Area	3	3	3
Buildings/Support Services	75	175	296
Aquaculture and Other Ocean-Water Activities	385	285	165
Total HOST Acreage	463	463	464
NELH:			
Lab	6	6	6
Office Area	3	3	3
Aquaculture:			
Committed Lands ¹	35	35	35
R&D, Small Parcels	60	60	60
Commercial, Large Parcels	18	18	18
	to	to	to
	60	60	60
Solar Ponds	21	21	21
	to	to	to
	63	63	63
Unplanned	99	99	99
Total NELH Acreage	284	284	284

¹ Hawaiian Abalone Farms, 21.3 acres; Cynotech, 14 acres.

Table 2-b.— POTENTIAL SOCIO-ECONOMIC IMPACTS:
Average Annual Construction Employment and Income¹

Item	HOST Scenario for Pond Area		
	A Maximum	B Medium	C Minimum
Direct Jobs:			
Pipes ²	3	3	3
HOST:			
Commercial Area ³	9	9	9
Buildings/Support Services ⁴	30	70	118
Aquaculture and Other Ocean-water Activities ⁵	19	14	8
NELH:			
Office Area ⁶	3	3	3
Aquaculture and Solar Ponds ⁵	9	9	9
Total Direct Jobs	73	108	150
Direct plus Indirect Jobs⁷			
West Hawaii ⁸	183	270	375
Elsewhere	88	130	180
	95	140	195
Average Salary (1984 dollars):			
Direct Construction Jobs	\$26,560	\$26,560	\$26,560
Indirect Jobs	\$21,900	\$21,900	\$21,900
Total Household Income (million 1984 dollars)	\$ 4.3	\$ 6.4	\$ 8.9

¹ Assumed 10-year development period. Actual construction employment will vary greatly from average employment.

² 10 pipes, construction crew of 10, 4-month construction period.

³ 30 man-years/acre.

⁴ 4 man-years/acre.

⁵ 0.5 man-years/acre.

⁶ 10 man-years/acre.

⁷ 2.5 direct plus indirect jobs per direct job.

⁸ 1.2 times direct jobs.

Table 2-c.— POTENTIAL SOCIO-ECONOMIC IMPACTS:
Operating Employment and Income, Full Development

Item	HOST Scenario for Pond Area		
	A Maximum	B Medium	C Minimum
Onsite Jobs:			
HOST:			
Commercial Area and Support ¹	65	65	65
Buildings/Support Services ²	750	1,750	2,960
Aquaculture and Other Ocean-water Activities ³	385	285	165
NELH:			
OPEC, Lab, Offices ⁴	25	25	25
Aquaculture:			
Committed Lands ⁵	120	120	120
R&D, Small Parcels ⁶	180	180	180
Commercial, Large Parcels ³	18	18	18
	to	to	to
	60	60	60
Solar Ponds ⁴	2	2	2
	to	to	to
	4	4	4
Total Onsite Employment ⁷	1,590	2,490	3,580
Skilled and Professional ⁸	400	620	900
Semi-skilled ⁸	630	1,000	1,430
Unskilled ⁸	560	870	1,250
Direct Jobs ⁹	1,480	2,390	3,500
Direct plus Indirect Jobs ¹⁰	2,520	4,060	5,950
West Hawaii ¹¹	1,780	2,870	4,200
Elsewhere	740	1,190	1,750
Average Annual Salary (1984 dollars):			
Direct Jobs: ¹²			
Skilled and Professional	\$30,000	\$30,000	\$30,000
Semi-skilled	\$20,000	\$20,000	\$20,000
Unskilled	\$15,000	\$15,000	\$15,000
Indirect Jobs ¹³	\$16,880	\$16,880	\$16,880
Total Annual Household Income (million 1984 dollars)	\$48.7	\$78.2	\$114.4

Table 2-c.— POTENTIAL SOCIO-ECONOMIC IMPACTS:
Operating Employment and Income, Full Development
(continued)

- ¹Includes 3 guards, 1 visitor center employee, 2 guides, 40 restaurant employees, 6 snack bar employee, 2 convenience-shop employees, 3 office workers, 3 grounds-keepers, and 5 support professionals.
- ²10 jobs/acre.
- ³1 employees/acre.
- ⁴Direct estimate.
- ⁵Current plans: 100 for Hawaiian Abalone Farms, 20 for Cyanotech.
- ⁶3 jobs/acre.
- ⁷Based on maximum aquaculture development.
- ⁸25% skilled and professional, 40% semi-skilled, and 35% unskilled.
- ⁹Indirect jobs generated by aquaculture and located in the building/support services area are assumed to equal 15% of total aquaculture jobs; hence direct jobs = total onsite jobs - 15% of aquaculture jobs.
- ¹⁰1.7 times direct jobs, reflecting vertical integration.
- ¹¹1.2 times direct jobs.
- ¹²Assumed.
- ¹³State average.

Table 2-d.— **POTENTIAL SOCIO-ECONOMIC IMPACTS:**
Population and Housing, Full Development

Item	HOST Scenario for Pond Area		
	A Maximum	B Medium	C Minimum
Population			
West Hawaii	5,040	8,120	11,900
Elsewhere	3,560	5,740	8,400
	1,480	2,380	3,500
Housing			
West Hawaii	1,680	2,710	3,970
Elsewhere	1,190	1,910	2,800
	490	800	1,170

¹ 2 people per job.

² 3 people per home.

REFERENCES

Dung, Elaine, and Wakui, Lawrence S. Aquacultural Occupational Task Analysis. University of Hawaii, Office of the Chancellor for Community Colleges. Honolulu. June 1980.

Hawaii County Department of Parks and Recreation. County of Hawaii Recreation Plan. Hilo. 1973.

Hawaii County Department of Planning. Kona Regional Plan (Draft). Hilo. 1982.

Hawaii County Department of Planning. Revisions to Draft Kona Regional Plan. Hilo. 1983.

Hawaii County Police Department. Annual Report 1970 - 71. Hilo. 1971.

Hawaii County Police Department. Annual Report 1980 - 81. Hilo. 1981.

Hawaii County Police Department. Annual Report 1981 - 82. Hilo. 1982.

Hawaii County Police Department. Annual Report 1982 - 83. Hilo. 1983.

Hawaii County Police Department. Annual Report 1983 - 84. Hilo. 1984.

Hawaii Opinion, Inc. Survey of Big Island Residents on Planning and Housing Concerns. Prepared for County of Hawaii, Office of Housing and Community Development. Honolulu. December 1983.

Hawaii State Census Statistical Areas Committee. Estimated Population of Hawaii by Districts, 1983. Report CTC-60. Honolulu. September 4, 1984.

Hawaii State Department of Planning and Economic Development. The State of Hawaii Data Book—1984: A Statistical Abstract. Honolulu. February 1985a.

Hawaii State Department of Planning and Economic Development, Research & Economic Analysis Division. "The Population of Hawaii, 1970-1984: Technical Supplement." Statistical Memorandum 85-3. Honolulu. May 8, 1985b.

Hawaii State Department of Planning and Economic Development, Research & Economic Analysis Division. Unpublished material on employment multipliers.

Hawaii State Department of Social Services and Housing. Statistical Report on Child Abuse and Neglect, 1980. Honolulu, 1981.

Hawaii State Department of Social Services and Housing. Statistical Report on Child Abuse and Neglect, 1981. Honolulu, 1982.

Hawaii State Department of Social Services and Housing. Statistical Report on Child Abuse and Neglect, 1982. Honolulu, 1983.

Hawaii Visitors Bureau. Visitor Plant Inventory. Honolulu. June 1980.

Hawaii Visitors Bureau. Visitor Plant Inventory. Honolulu. February 1985.

SMS Research, Inc. The 1984 Hawaii State Plan Survey. Appendix Report: Detailed Results. Prepared for State of Hawaii, Department of Planning and Economic Development, Planning Division. Honolulu. December 1984.

State of Hawaii. Report of the Governor's Aquaculture Industry Development Committee. Honolulu. April 1984.

U.S. Bureau of the Census, 1980 Summary Tape Files 1-A and 3-A.

APPENDIX H

PUBLIC INFORMATION MEETING

A public information meeting to discuss the HOST project and the draft environmental impact statement was held at the Kona Lagoon Lounge, Kailua-Kona, on July 8, 1985 at 7:00 P.M. A news release announcing the meeting was sent to the following on June 25, 1985:

West Hawaii Today
P.O. Box 789
Kailua-Kona, HI 96745

PUA, News Director
177 Kilauea Avenue
Hilo, HI 96720

News Editor
Hawaii Tribune-Herald
P.O. Box 767
Hilo, HI 96720

Manager, KHLO
400 Hualani St.
Hilo, HI 96720

News Director, KIPA
P.O. Box 1602
Hilo, HI 96720

KKON, News Director
P.O. Box 845
Kealahou, HI 96750

Personal letters were sent to the following organizations and individuals:

BJORT/WHCCES
Mr. Stan Michaels
Kealahou

Hawaii County Taxpayers Association
Ms. Wanda Dettling
Kailua-Kona

Hawaii Hotel Association
Mr. Mike White, President
Mauna Lani Day Hotel
Kawaihae

Hawaii Island Contractors Association
Mr. Bill Riersem, Chairman
Kailua-Kona

Hawaii Island Economic Development Board
Mr. Clint Taylor
Kailua-Kona

Hawaii Leeward Planning Conference
Mr. Pete L'Orange
Kailua-Kona

Hualalai Exchange Club
Mr. Robert Triantos, Chairman
Kailua-Kona

Kailua-Kona Lions Club
Mr. Frank McGuirk, Sr., President
Kailua-Kona

Kailua Village Association/
Kailua Activities Pier Program
Mr. Frank Zuzak
Kailua-Kona

Kailua Village Special District Commission
Mr. Robert Triantos, Chairman
Kailua-Kona

Kainaliu Business and Professional Association
Ms. Patty Vaughan Butler
Kealahou

Kohala Community Association
Mr. Michael Gomes, President
Kapaa

Kona Board of Realtors
Mr. Putman Clark, President
Kailua-Kona

Kona Crime Prevention Committee
Mr. Rod Leicht
Kailua-Kona

Kona Farm Bureau Federation
Mr. Arthur Takahara, President
Captain Cook

Kona Farmers' Cooperative
Mr. Kanu Uyeda, President
Captain Cook

Kona-Kohala Chamber of Commerce
Mr. Bill Knutson, President
Kailua-Kona

Kona Lions Club
Mr. William Paris, President
Kealahou

Conservation Council for Hawaii
Mr. Rick Scudfder
Honolulu

Life of the Land
Honolulu

Friends of Kamao Point
Ms. Frances Schobel
Honaunau

Kona Conservation Group
Mr. Douglas Blake
Kailua-Kona

Public Access Shoreline Hawaii
Mr. Jerry Rothstein
Kailua-Kona

Na Ala Hele
Ms. Debbie Abreu
Kealahou

DHA
Ms. Moanikeala Akaka
Hilo

The following individuals attended the meeting:

James Suqai
Kealahou

Bill Knutson
Kailua-Kona

C.R. Cartwright
Kailua-Kona

Deana Ruse
Seal Beach, CA

Richard Matsumoto
Kealahou

Arthur Takahara
Captain Cook

James Sorji
Holualoa

Amelia Gay
Kailua-Kona

Kona Mauka Rotary Club
Mr. Eric Curtiss, President
Kealahou

Kona Outdoor Circle
Mrs. Nancy Frazier, President
Kailua-Kona

Kona Rotary Club
Mr. Mark Rife, President
Kailua-Kona

Kona Young Farmers
Mr. Nathan Kurashige, President
Holualoa

Kuakini Exchange Club
Mr. Dana Smith, President
Kailua-Kona

LESA
Mr. Pete L'Orange
Kailua-Kona

Napoop-Honaunau Community Association
Mrs. Hai Kamakau
Captain Cook

South Kona Aloha Lions Club
Mr. Adelin Coil, President
Captain Cook

Waikoloa Village Association
Mr. Bill Lathers, President
Kamuela

Waima-Kawaihai Community Association
Mr. Mark Duncan, President
Kamuela

West Hawaii Committee
Mr. Don McIntosh
Kailua-Kona

West Hawaii Housing Foundation
Rev. Leon Sterling, President
Kailua-Kona

Hawaii Visitors Bureau
75-5717 W. Alii Drive
Kailua-Kona

Roy Gay
Kailua-Kona

Peter Young
Kailua-Kona

Elliot Pulham
Kealahou

Clint Taylor
Island Economic Development Board
Kailua-Kona

Mike Griggs
Kailua-Kona

Steven B. Ruse
Solus Ocean Systems, Inc.
Long Beach, CA

Thomas Daniel
NELH
Kailua-Kona

Christine Okuda
R. M. Towill Corp.
Honolulu

David F. Eldridge
Kailua-Kona

Bruce Tsuchida
R. M. Towill Corp.
Honolulu

Gerald Lesperance
Energy Division, DPED
Honolulu

Marni Herkes
Kailua-Kona

Marilynn Neely
Honolulu

Kelen K. Danford
NELH
Kailua-Kona

Marilynn C. Metz
The Traverse Group, Inc.
Honolulu

William M. Bass
HTDC
Honolulu

Kay T. Yamada
HTDC
Honolulu

Jack Huizingh
NELH
Kailua-Kona

George Lockwood
Hawaiian Abalone Farms
Kailua-Kona

Linda K. Rosehill
DPED
Honolulu

Alfie Fujitani
Kona Chamber of Commerce
Kailua-Kona

William Moore
Scott Leithhead
County of Hawaii
Office of Housing and Community Development
Hilo

There were no adverse comments about the project voiced at the meeting.

The following individuals were unable to attend the evening meeting; however, they met with representatives of the High Technology Development Corporation and The Traverse Group, Inc. earlier in the day to discuss the project:

Ms. Frances Schobel, Friends of Kamao Point
Ms. Moanikeala Akaka, Office of Hawaiian Affairs
Mr. Kaipo Akaka, Concerned Hawaiians
Mr. John K. Spencer
Mr. Ka'ipo Dequair
Mr. Skippy Donane
Mr. Gordon Leslie



George R. Ariyoshi
Governor

Jews Release

High Technology Development Corp.
William M. Bass, Jr. - #548-8996

JUNE 26, 1986

A DRAFT ENVIRONMENTAL IMPACT STATEMENT (EIS) IS ABOUT TO BE FILED ON BEHALF OF THE HAWAII OCEAN SCIENCE AND TECHNOLOGY PARK (HOST PARK) AND NATURAL ENERGY LABORATORY OF HAWAII (NELH) OPERATIONS AT KEAHOLE POINT, KAILUA-KONA, ISLAND OF HAWAII.

IN ANTICIPATION OF QUESTIONS AREA RESIDENTS MAY HAVE ON THESE ACTIVITIES, STATE OFFICIALS HAVE SCHEDULED AN INFORMAL, PUBLIC INFORMATION MEETING FOR MONDAY, JULY 8, 1985 FROM 7:00 P.M. to 8:30 P.M. AT THE KONA LAGOON HOTEL, 78-6780 ALII DRIVE, KAILUA-KONA, HAWAII. THE PUBLIC IS CORDIALLY INVITED TO ATTEND.

INQUIRIES SHOULD BE ADDRESSED TO BILL BASS, EXECUTIVE DIRECTOR, HIGH TECHNOLOGY DEVELOPMENT CORPORATION AT 548-8996.



HIGH TECHNOLOGY DEVELOPMENT CORPORATION

Central Pacific Plaza 220 South King Street, Suite 252
Honolulu (808) 548-8996

GEORGE R. ARYOSHI
Governor
K. TIM YEE
Deputy Governor
WILLIAM M. BASS, JR.
Executive Director

Mailing Address: P.O. Box 2390 Honolulu Hawaii 06904

June 24, 1986

Ms. Debbie Abreu
Ma Ala Hele
POB 1572
Kealahou, Hawaii 96760

Dear Ms. Abreu:

As you may already be aware, the High Technology Development Corporation of the State of Hawaii has proposed plans to develop a Hawaii Ocean Science and Technology Park at Keahole, Kailua-Kona, Island of Hawaii.

I will be in Kona on July 8, 1985 and would be available to meet with you to discuss this project and answer any questions you may have. My schedule is open from 12:30 p.m. through 5:30 p.m. on Monday to meet with you. If you are interested in meeting, I would be happy to arrange a convenient time. Please call me at #548-8996 or #548-8997 or write my office at Central Pacific Plaza, 220 South King Street, Suite 252, Honolulu, Hawaii 96813.

Also, there will be a public informational meeting from 7:00 p.m. to 8:30 p.m. on the same day at the Kona Lagoon Hotel, 78-6780 Alii Drive, Kailua-Kona, Hawaii. We will have a short slide presentation following introductions, and attendees will have an opportunity to ask questions. If you are not available earlier during the day and would like to meet, perhaps you will be able to attend this meeting.

Very truly yours,

William M. Bass, Jr.
William M. Bass, Jr.
Executive Director



HIGH TECHNOLOGY DEVELOPMENT CORPORATION

Central Pacific Plaza, 220 South King Street, Suite 215
Honolulu, (808) 548-8996

GEORGE R. ARYOSHI
GOVERNOR
K. TIM YEE
COMMISSIONER
WILLIAM M. BASS, JR.
EXECUTIVE DIRECTOR

Mailing Address: P.O. Box 2359, Honolulu, Hawaii 96804

June 26, 1985

Maimea-Kawaihae Community Assoc.
Mr. Mark Duncan, President
P.O. Box 2045
Kamuela, Hawaii 96743

Dear Mr. Duncan:

SUBJECT: Notice of a Public Informational Meeting Regarding the Hawaii Ocean Science and Technology Park (HOST Park) Development Plans, Keahole, Kailua-Kona, Island of Hawaii.

A public informational meeting has been scheduled for Monday, July 8, 1985 from 7:00 p.m. to 8:00 p.m. at the Kona Lagoon Hotel, 78-6780 Alii Drive, Kailua-Kona, Hawaii 96740. The purpose of this meeting is to discuss the proposed development plans of the HOST Park and answer any questions concerning this project.

We hope that you or a member from your staff will be available to attend this meeting. Should you have questions in the meantime, please feel free to contact me at 548-8996. We look forward to seeing you there.

Sincerely,

William M. Bass, Jr.
Executive Director

APPENDIX I

**LIST OF PREVIOUS ARCHAEOLOGICAL SURVEYS
AT HOST PARK AND NELH SITES**

The list of references that follows was prepared by Ross Cordy, Department of Land and Natural Resources, Historic Sites Section.

REFERENCES FOR ARCHAEOLOGICAL STUDIES IN THE
NELH & HOST PARK AREAS OF KEAHOLE POINT

NELH Archaeological References

- Reinecke, John 1930. Survey of Sites on West Hawaii. Bishop Museum Manuscript. On file, Historic Sites Section. [1930 Survey]
- Ching, Francis Jr. and Deborah Cluff, Thomas Riley 1968-69. Preliminary Report of Archaeological Surface Survey & Salvage Operations at Keahole, North Kona, Hawaii Island. Section II Keahole Point Airport & Kailua-Kawaihae Road. Manuscript H-50. On file, Historic Sites Section. [1968-69 Survey]
- Rosendahl, Paul and Patrick Kirch 1975. Archaeological Reconnaissance Survey of the Ke-ahole Point Natural Energy Laboratory Site, North Kona, Hawaii Island. Bishop Museum Manuscript 111775. On file, Historic Sites Section (H-81). [1975 Survey]
- Cordy, Ross 1975. Scale maps of sites analyzed for Ph.D. work, with dates and interpretations. On file, Bishop Museum & Historic Sites Section. [1975 Survey w/excavations & dates]
- 1978. A Study of Prehistoric Social Change: The Development of Complex Societies in the Hawaiian Islands. Ph.D. thesis, University of Hawaii. [Same 1975 study]
- 1981. A Study of Prehistoric Social Change: The Development of Complex Societies in the Hawaiian Islands. New York, Academic Press. [Same 1975 study]
- Rosendahl, Paul 1976. Additional Archaeological Reconnaissance Survey at the Ke-ahole Point Natural Energy Laboratory Site, North Kona, Hawaii Island. Bishop Museum Manuscript #111775 Appendix. On file, Historic Sites Section (H-81). [1976 survey]
- Rogers-Jourdane, Elaine 1978. Archaeological Reconnaissance Survey of NELH Facilities Area at Keahole Point, North Kona, Hawaii. Bishop Museum Manuscript #061378. On file, Historic Sites Section (H-82). [1978 survey]

Rogers-Jourdane, Elaine 1978. Archaeological Reconnaissance Survey of NELH Facilities Area at Keahole Point, North Kona, Hawaii. Bishop Museum Manuscript #081378. On file, Historic Sites Section (H-82). [1978 survey]

Rosendahl, Paul 1980. Intensive Archaeological Survey and Salvage Excavations at the Natural Energy Laboratory Hawaii (NELH) Site, Ke-ahole Point, North Kona, Hawaii Island: Final Report. Paul H. Rosendahl Company Manuscript 2-123179. On file, Historic Sites Section (H-81). [1978 survey w/excavations & dates]

Barrera, William 1979. Ke-ahole Airport Emergency Service Roads: Archaeological Survey. On file, Historic Sites Section (H-128). [1979 survey]

Barrera, William 1985. Ke-ahole Point, Hawaii: Archaeological Reconnaissance. Manuscript. On file, Historic Sites Section. [1985 survey]

*These studies and other archaeological projects in the Ooma & Kalaoa land units in North Kona are summarized and reviewed in a Historic Sites Section report. (Cordy, Ross 1985. Working Paper 1. Hawaii Island Archaeology. Ooma & Kalaoa Ahupua'a, Kekaha, North Kona.)

RC:rc
8/27/85

Rosendahl, Paul 1980. Intensive Archaeological Survey and Salvage Excavations at the Natural Energy Laboratory Hawaii (NELH) Site, Ke-ahole Point, North Kona, Hawaii Island: Final Report. Paul H. Rosendahl Company Manuscript 2-123179. On file, Historic Sites Section (H-81). [1978 survey w/excavations and dates]

Clark, Stephen 1984. An Archaeological Reconnaissance of Natural Energy Laboratory Hawaii (NELH) Property, Keahole Point, North Kona, Hawaii. Bishop Museum Manuscript 110784. On file, Historic Sites Section H-439). [1984 survey & review]

HOST PARK

Reinecke, John 1930. Survey of Sites on West Hawaii. Bishop Museum Manuscript. On file, Historic Sites Section. [1930 survey]

Ching, Francis Jr. and Deborah Cluff, Thomas Riley 1968-69. Preliminary Report of Archaeological Surface Survey & Salvage Operations at Keahole, North Kona, Hawaii Island. Section II Keahole Point Airport & Kailua-Kawaihae Road. Manuscript H-50. On file, Historic Sites Section. [1968-69 survey]

Department of Land & Natural Resources 1971-72. Site Inventory Files for Sites 1910-1920. On file, Historic Sites Section. [1971-72 inventory of known sites]

Rosendahl, Paul and Patrick Kirch 1975. Archaeological Reconnaissance Survey of the Ke-ahole Point Natural Energy Laboratory Site, North Kona, Hawaii Island. Bishop Museum Manuscript 111775. On file, Historic Sites Section (H-81). [1975 survey]

Cordy, Ross 1975. Scale maps of sites analyzed for Ph.D. work, with dates and interpretations. On file, Bishop Museum & Historic Sites Section. [1975 survey w/excavations & dates]

----- 1978. A Study of Prehistoric Social Change: The Development of Complex Societies in the Hawaiian Islands. Ph.D. thesis, University of Hawaii. [Same 1975 study]

----- 1981. A Study of Prehistoric Social Change: The Development of Complex Societies in the Hawaiian Islands. New York. Academic Press. [Same 1975 study]

APPENDIX J
COMMENTS AND RESPONSES TO THE DRAFT EIS

COMMENTS AND RESPONSES ON THE DRAFT ENVIRONMENTAL IMPACT STATEMENT

The following agencies, organizations and individuals reviewed and commented on the draft Environmental Impact Statement. Those who made substantive comments concerning the proposed action received written responses to their concerns. They are indicated by an asterisk (*) in the following list. All of the letters received, together with responses to all substantive comments, are reproduced on the following pages of this Appendix.

Federal Agencies

Department of Agriculture, Soil Conservation Service
*Department of the Army, U.S. Army Engineer District
Department of Commerce, National Oceanic and Atmospheric Administration
 *National Marine Fisheries Service
Department of Energy
 *Pacific Site Office
 *Solar Energy Research Institute
Department of Housing and Urban Development
Department of the Interior
 *Fish and Wildlife Service
 *Geological Survey, Water Resources Division
Department of the Navy
Department of Transportation
 Federal Aviation Administration
 U.S. Coast Guard

State Agencies

*Department of Accounting and General Services
*Department of Agriculture
Department of Defense
Hawaii Housing Authority
*Department of Health
*Department of Land and Natural Resources
*Office of Environmental Quality Control
*Department of Planning and Economic Development
University of Hawaii at Manoa
 *Water Resources Research Center

State Legislature

Representative Wayne Metcalf

County of Hawaii

- *Department of Parks & Recreation
- *Department of Public Works
- Department of Water Supply
- *Fire Department
- *Office of Housing and Community Development
- *Planning Department

Individuals and Organizations

- *Hawaii Electric Light Company, Inc.
- *Jacque Prell
- *TSA International, Limited



United States
Department of
Agriculture

Soil
Conservation
Service

P.O. Box 50004
Honolulu, HI
96850

August 6, 1985

Ms. Letitia N. Uyehara, Director
Office of Environmental Quality Control
550 Halekauwila Street, Room 301
Honolulu, Hawaii 96813

Dear Ms. Uyehara:

Subject: Draft EIS - Development Plan for Hawaii Ocean Science and
Technology Park and Proposed Expansion of Natural Energy
Laboratory of Hawaii, Keahole, North Kona, Hawaii

We reviewed the subject draft environmental impact statement and
have no comments to make.

Thank you for the opportunity to review the document.

Sincerely,

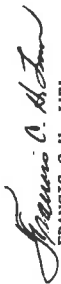
FRANCIS C.H. LUM
State Conservationist

CC:
William M. Bass, Jr., High Technology Development Corporation, Central
Pacific Plaza, Suite 252, 220 South King Street, Honolulu, HI 96813
Marilynn C. Metz, The Traverse Group, Inc., P.O. Box 27506, Honolulu,
HI 96827

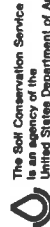

**HIGH TECHNOLOGY
DEVELOPMENT
CORPORATION**

Central Pacific Plaza, 220 South King Street, Suite 252
Telephone (808) 548-6936

August 27, 1985

Mailing Address: P O Box 2359 Honolulu, Hawaii 96804

GEORGE R. ARIVOSH
KIM YEE
WILLIAM M. BASS, JR.
Executive Director



DEPARTMENT OF THE ARMY
U. S. ARMY ENGINEER DISTRICT, HONOLULU
FT SHAFTER, HAWAII 96858

August 9, 1985

REPLY TO
ATTENTION OF



Mr. William M. Bass, Jr.
High Technology Development Corporation
Central Pacific Plaza, Suite 262
220 S. King Street
Honolulu, Hawaii 96813

Dear Mr. Bass:

Thank you for the opportunity to review and comment on the Draft EIS for Development Plan for Hawaii Ocean Science and Technology Park. Tsunami flooding hazards have been identified in the Draft EIS (pp. IV-14, 15) since the coastal flood plain extends along most of the North Kona coastline. We recommend that proposed structures be located outside of the flood plain or tsunami inundation areas identified by the Flood Insurance Study for Hawaii County by the Federal Insurance Administration.

Sincerely,

Kisuk Cheung
Chief, Engineering Division

Copy Furnished:

Ms. Letitia N. Uyehara, Director
Office of Environmental Quality Control
550 Halekauwila Street
Room 301
Honolulu, Hawaii 96813

Mr. Kisuk Cheung
Chief, Engineering Division
Department of the Army
U.S. Army Engineer District, Honolulu
Ft. Shafter, Hawaii 96858

Dear Mr. Cheung:

Subject: Draft Environmental Impact Statement -- Development Plan for the Hawaii Ocean Science & Technology Park and Proposed Expansion of the Natural Energy Laboratory of Hawaii at Keahole, North Kona, Hawaii

Thank you for commenting on the subject draft EIS. As you recommend, wherever possible all structures will be located outside of the flood plain or tsunami inundation areas identified by the Flood Insurance Study for Hawaii County by the Federal Insurance Administration. An exception may be pipes and pumps which will be designed to withstand design wave conditions.

Sincerely,

William M. Bass, Jr.
William M. Bass, Jr.
Executive Director

WMB/st

cc: ORQC
Land Use Commission
County of Hawaii Planning Dept.
NELH
DPED Energy Division



U.S. DEPARTMENT OF COMMERCE
National Oceanic and Atmospheric Administration
NATIONAL MARINE FISHERIES SERVICE

Southwest Region
Western Pacific Program Office
P. O. Box 3830
Honolulu, Hawaii 96812

August 21, 1985

F/SWRI:JJN

Ms. Letitia N. Uyehara, Director
Office of Environmental Quality Control
550 Halekauwila Street, Room 301
Honolulu, HI 96813

Dear Ms. Uyehara:

The National Marine Fisheries Service (NMFS) has reviewed the Draft Environmental Impact Statement (DEIS), Development Plan for Hawaii Ocean Science and Technology (HOST) Park and Expansion of Natural Energy Laboratory of Hawaii (NELH), Keahole, North Kona, Hawaii. We offer the following comments for your consideration:

General Comments

NMFS submitted comments on the EIS Preparation Notice for the proposed project on April 19, 1985. The majority of our comments and suggestions were dealt with in the DEIS, particularly those concerning potential impacts on commercial fishing and threatened and endangered species under NMFS jurisdiction. We wish to point out that Section 7 consultation under the Endangered Species Act of 1973 should be initiated with this office by the proposing agency.

We have serious reservations concerning the recommended method of seawater disposal; that of on-land disposal by surface trench of up to 144 mgd at maximum HOST Park development. Analysis by NMFS staff indicates that calculated disposal seawater residence times are based on inappropriate models and would breakdown in the event a lava tube intercepts the flow field. The repeated assertion in the DEIS that an alternate disposal method can be deployed if monitoring reveals operational problems suggests that the logical basis for on-land disposal is weak. Potential impacts from on-land disposal, both open trenches and gravity injection wells, could have major adverse impacts on anchialine pond and nearshore biota. NMFS feels greater consideration should be given to a properly designed ocean outfall.

There are numerous statements made throughout the text of the DEIS which need to be referenced.

Specific Comments

D. Ocean Use Corridor

Page II-23, Paragraph 5. We find it hard to visualize that additional cold water pipes could safely be accommodated within the existing sand channel corridor off Keahole Point, given the physical constraints imposed by the width of the corridor and the designed lateral mobility of the pipelines.

4.1 Existing Conditions

Page IV-25, Paragraph 8. This paragraph states that dense beds of finger coral, Porites compressa, are found off Keahole Point. NMFS surveys indicate coral coverage is relatively sparse immediately off Keahole Point but considerably richer off the proposed HOST Park shoreline.

Page IV-26, Paragraph 4. Although Harrison (1985) observed large aggregations of ta'ape, Lutjanus kasmira, at a depth of 300 feet off Keahole Point, he did not actually witness them foraging, as stated here.

Page IV-27, Paragraph 3. The latest estimates of the Hawaiian population of humpback whales puts total numbers at about 1200 individuals.

Page IV-27, Paragraph 6. This paragraph discussing coral coverage is misleading as it indicates that over 80% of total bottom cover off Keahole Point is live coral. Coral coverage is discussed throughout this section on "Existing Conditions" and should be consolidated under one sub-section.

1.2 Injection Wells

Page IV-33, Paragraph 4. It is our understanding that the two ocean water disposal wells used by Hawaiian Abalone Farms have become plugged and are no longer operational.

2.2 Environmental Impacts and Mitigation Measures (Proposed Ocean Outfall)

Page IV-34, Paragraph 4. Harrison (1985) analyzed benthic productivity at depth in excess of 150 meters, in order to assess potential impacts from future effluent discharges off Keahole Point. He concluded that a lack of impact will result from advection of the plume offshore and away from the area before nutrients become biologically available. It is also unlikely that fauna in the path of the plume could be altered such that they resemble those at much deeper depths since the substrates are totally different.

3.4.4 Recommendations

Page IV-40, Paragraph 7. The statement is made that, "If on-land disposal is selected as the method of seawater return flow disposal, the decision should be based primarily on cost effectiveness and ease of maintenance." NMFS feels comparative environmental impacts should play an equal role in selection of the seawater disposal method.

HIGH TECHNOLOGY DEVELOPMENT CORPORATION

Capital Pacific Plaza 220 South King Street, Suite 252
Telephone (908) 548-8996

Mailing Address P.O. Box 2359 Honolulu, Hawaii 96804

August 29, 1985



Page IV-41, Paragraphs 7 and 8. By the time impacts of on-land disposal have been determined to be unacceptable, significant damage to anchialine pond resources and nearshore coral reef communities may already have occurred. We feel these resources will not revert to their original state within a short period of time after termination of on-land disposal, as indicated in this section of the DEIS.

Thank you for the opportunity to comment on the subject DEIS. NMFS looks forward to further project coordination concerning living marine resources under our jurisdiction.

Sincerely yours,

Doyle E. Gates

Doyle E. Gates
Administrator

cc: F/SWR, Terminal Island, CA
EPA, Region IX, San Francisco, CA (P-5)
FWS, Honolulu, HI
Corps of Engineers, Honolulu District
Hawaii State Div. of Aquatic Resources
High Tech. Development Corp. (William Bass)
The Traverse Group, Inc. (Marilynn Metz)

Mr. Doyle E. Gates, Administrator
National Marine Fisheries Service
U.S. Department of Commerce
National Oceanic and Atmospheric Administration
Southwest Region, Western Pacific Program Office
P.O. Box 3830
Honolulu, Hawaii 96813

Dear Mr. Gates:

Subject: Draft Environmental Impact Statement -- Development Plan for the Hawaii Ocean Science & Technology Park and Proposed Expansion of the Natural Energy Laboratory of Hawaii at Keahole, North Kona, Hawaii

Thank you for your comments on the subject draft EIS. Your comments were forwarded to our subconsultants, Dames & Moore, G.K. & Associates, and Edward K. Noda & Associates, Inc. for technical information. The following responses are in part prepared by them. To respond to your general comments:

Section 7 consultation will be initiated for the NELH site when federal funding is involved, and at HOST Park if federal funding should be used for some project in the future. At the present time, HOST is entirely State-funded.

We do not agree that the models used to calculate residence times are inappropriate. The effect of the lava tubes and cavities present in the type of volcanic terrain found at the site would be to increase the anisotropy of the flow field. The expanding cylinder model partially accounts for anisotropy by limiting the expansion of the plume field in the vertical direction.

The models used are simplistic, but are appropriate considering the relatively low importance of residence times in assessing impacts in this case. The sea water return water would be nearly indistinguishable from the ocean water when it merges and the rate of discharge per unit area would be low.

Mr. Doyle E. Gates
August 29, 1985
Page 2

Although the sea water return water residence times would be somewhat reduced by the anisotropic effects of lava tubes, this is actually a more conservative assumption for the more significant environmental effects of land disposal. The anisotropy would result in the plume size (area of groundwater disruption) being smaller than that calculated. The potential for impacts on anchialine ponds would therefore be reduced.

The proposed monitoring is not based on any expectation that the effects of land disposal would be significant or rapid. With appropriate mitigating measures, such as pre-treatment and warming of the discharged water, the potential for impact on nearshore biota is minimal, and the impacts on anchialine ponds would occur over extended periods of time, if they occur. An outfall or outfalls may be considered in the future if the results of the monitoring of trench disposal indicate that the potential for impacts is more significant than assumed at the present. Based on available funding, the initial phase of the HOST Park development will only include 1 24-inch pipe. The initial disposal flow, therefore, will be approximately 6,000 gpm. Three monitoring wells are also planned for construction immediately. The relatively low flow, and continual monitoring, will allow alternative disposal methods to be designed and employed if testing indicates that unforeseen significant adverse impacts will occur. Of particular importance to the success of the Park and NELH is the quality of the source waters. Monitoring data, therefore, will be subject to very conservative interpretation.

In answer to your specific comments:

Page II-23, Paragraph 5: An analysis conducted by Makai Ocean Engineering indicated that catenary touching and bottom placement accuracy for additional pipelines offshore NELH are not major problems. With the current design methods, they concluded that up to three more pipes could be installed within the channel without major interference problems during deployment and operation. Depending on the actual design and placement methods, more pipelines could be placed in the channel. However, they did not recommend this approach due to the increased risks involved. Because of the high risks associated with the installation of additional pipelines, they recommended placing not more than two additional catenary pipelines in the existing channel.

Page IV-25, Paragraph 8: We agree with this comment. In condensing information from various sources, two statements became linked into a single paragraph and a key distinction

Mr. Doyle E. Gates
August 29, 1985
Page 3

inadvertently dropped. The second sentence of this paragraph will be prefaced by the phrase, "South of Keshole Point,..." Page IV-26, Paragraph 4: In the Final EIS the word "foraging" will be deleted from the sentence.

Page IV-27, Paragraph 3: The final EIS has been changed to reflect the figure of 1200.

Page IV-27, Paragraph 6: The context is more fully developed in Appendix F where Dollar's 1977 survey results are discussed. To clarify the statement in the body of the text, the word "the" will be replaced with the word "some" in the second sentence of this paragraph in the Final EIS.

Page IV-33, Paragraph 4: The ocean water disposal wells used by Hawaiian Abalone Farms were operational at the time of our field investigation in May, 1985. These wells were installed without any attempt at design and there are no measures to treat the disposal water or to prevent air entrainment. For the proposed land disposal systems, the EIS contains discussions addressing reduction of clogging potential and maintenance requirements.

Page IV-34, Paragraph 4: Paragraph 4 of page IV-34 will be revised to read as follows: Elevated nutrient concentrations in the discharge will occur above the nutricline and at least partially within the mixed layer, resulting in subsidies to primary producers, mainly phytoplankton. This discharge will also be characterized by elevated levels of trace elements, low dissolved oxygen concentrations and trace levels of chlorine. A multi-year, federally-funded field data collection and analysis program (Univ. of Cal., Berkeley; in prep.) now nearing completion, has concluded that the presently planned OTEC discharge will not have any significant impact.

Page IV-40, Paragraph 7: Comparative environmental effects were already considered, and it was concluded that there should be no significant environmental difference between land disposal by trenches or by wells. Therefore, if on-land disposal is selected, the decision to dispose by trenches or wells should be based primarily on cost effectiveness and ease of maintenance.

Page IV-41, Paragraphs 7 and 8: We concur that this is possible, depending on the volume of flow initially disposed of, the rate of its increase, the characteristics of the flow, its residence time in the ground, the effectiveness of the monitoring program, and the tolerances of the affected biological communities. Brief tests of the disposal system will be included in the monitoring plan. The analysis in the EIS is

Mr. Doyle E. Gates
August 29, 1985
Page 4

based on full development of the Park to its maximum capacity. This in reality will take place over a considerable amount of time, and may never develop to the theoretical maximum. Conservative assumptions were made in assessing the plume size. The actual size of the plume is therefore smaller than calculated, and the time required for the plume to reach areas of significant anchialine ponds is longer than calculated. It should be emphasized that the anchialine ponds will not be destroyed, the characteristics of the water will change making them more saline. Damage to the corals from cold water temperatures can be prevented by following the recommended method of warming the water before discharge.

The purpose of the monitoring program is to determine the effects as the Park is developed so that changes can be instituted as necessary, not to wait until after damage may be done. As stated previously, the initial disposal flow from HOST Park is currently estimated to be approximately 6,000 gpm. Three monitoring wells are also planned for construction immediately. The relatively low flow, and continual monitoring, will allow alternative disposal methods to be designed and employed if testing indicates that unforeseen significant adverse impacts will occur. Of particular importance to the success of the Park and NELH is the quality of the source waters. Monitoring data, therefore, will be subject to very conservative interpretation.

We look forward to further coordination with you concerning living marine resources under your jurisdiction.

Sincerely,



William M. Bass, Jr.
Executive Director

cc: OEQC
LUC
County of Hawaii Planning Dept.
NELH
DPED, Energy Division



UNITED STATES
DEPARTMENT OF ENERGY

P.O. BOX 50168
HONOLULU, HAWAII 96850

August 19, 1985

Ms. Letitia N. Uyehara, Director
The Office of Environmental
Quality Control
550 Halekauwila Street, Room 301
Honolulu, Hawaii 96813

Dear Ms. Uyehara:

I have given the Draft EIS for HOST Park and the proposed expansion for NELH a cursory examination and am delighted to see these related projects proceeding on schedule. Their early completion should hasten the development of OTEC in Hawaii as a viable energy alternative to imported oil and establish a commercial spin-off to make the economics of the entire system more favorable.

The draft EIS appears to cover the critical developmental aspects adequately, and this office has no substantive recommendations to make on expanding or revising the study.

Attached is the copy you sent me of the EIS. Jack Huizingh sent me an additional copy, which I am retaining for our library.

Sincerely yours,

John W. Shupe

John W. Shupe, Director
Pacific Site Office

Attachment

cc: William Bass
Marilyn Metz
Jack Huizingh



**HIGH TECHNOLOGY
DEVELOPMENT
CORPORATION**

Central Pacific Plaza 220 South King Street, Suite 252
Telephone (608) 546-6996

Mailing Address: P O Box 2359 Honolulu, Hawaii 96804

August 27, 1985

Dr. John W. Shupe
Director
Pacific Site Office
U.S. Department of Energy
P.O. Box 50168
Honolulu, Hawaii 96850

Dear Dr. Shupe:

Subject: Draft Environmental Impact Statement -- Development Plan for the Hawaii Ocean Science & Technology Park and Proposed Expansion of the Natural Energy Laboratory of Hawaii at Keahole, North Kona, Hawaii

Thank you for reviewing the subject draft EIS. We appreciate your interest in and support of these important projects. We will send you a copy of the Final EIS for your library.

Sincerely,

William M. Bass, Jr.

William M. Bass, Jr.
Executive Director

WMB/st

cc: OEQC
Land Use Commission
County of Hawaii Planning Dept.
NELH
DPEED Energy Division

To: The Office of Environmental Quality Control
550 Halekaunila Street, Room 301
Honolulu, Hawaii 96813

Date: August 22, 1985

Subject: Comments on: Draft Environmental Impact Statement High Technology
Development Corporation Development Plan for
The Hawaii Ocean Science and Technology Park
and
Expansion of the Natural Energy Laboratory of Hawaii

The following comments are based on review of the EIS by both Carmine Castellano of DOE, Washington, and Floyd Blake of SERI. They are listed in order of importance to the planned DOE STF Upgrade piping system.

Page IV-24, paragraph 4:

The estimated required elevation of the warm and cold water pipes at the pump station for the DOE intake is approximately 17 feet below sea level. Since comparable water depth is found at the base of the shoreline cliff fronting NELH, little or no offshore trenching will be required.

Comment: The conceptual design of the STF Upgrade plans to trench and backfill with concrete for a distance of 410 feet from shore and to trench through the cliff a short distance to the on shore sump. The statement that little or no offshore trenching is required is not consistent with the currently known design.

Page II-23, paragraph 4,5:

A 15-inch cold water intake pipe is currently being installed within the ocean research corridor by Hawaiian Abalone Farms. The pumps will be located on shore and will deliver 2,000 gpm of cold water. An additional pipe of the same dimensions is anticipated to be deployed in spring 1986. These pipes are intended to be permanent. The HAF cold water system will also provide redundancy for NELH research projects.

It is estimated that three additional pipes could safely be accommodated within the sand channel offshore Keahole Point, which serves as the existing 12-inch cold water pipe route through an area of large basalt outcroppings and boulders. Any additional cold water pipes may need to be routed south of this area (and consequently south of the existing ocean research corridor) because of the increased risk of potential damage to the existing pipelines.

Comment: Clarification of paragraph 5 to state that three additional pipes beyond those of the Hawaiian Abalone Farms pipes is needed to make it clear that there is room for the three pipes of the STF Upgrade Project.

Figure II-13 and Figure 4-1 of Appendix B:

Comment: Makai header tank is nearly on line with airport runway. Is this really a good location for the tank?

Typos:

- Page vi, paragraph 4, typo: word "be" missing; "will be disposed of"
Page I-3, last paragraph, typo: word "the" repeated; "degrade the priority"
Page I-5, paragraph 5, typo: word "the" repeated; "the proposed HOST perk"
Page II-2, paragraph 5, typo: word "water" missing "a"
Page II-2, last paragraph, typo: word "as" should be "a"
Page III-7, paragraph 4, typo: word "belonging" spelled with i's

Cordially,

Floyd A. Blake

Floyd A. Blake

FB:jf
(FB2)Comm.Impct.Stmt

cc: High Technology Development Corporation
P. O. Box 2359
Honolulu, Hawaii 96804
Attention: Mr. William A. Bass, Jr.

The Traverse Group, Inc.

P. O. Box 27506

Honolulu, Hawaii 96827

Attention: Ms. Marilyn C. Metz

Mr. Takeshi Yoshihara

Energy Program Administrator

Department of Planning and Economic Development

P. O. Box 2359

Honolulu, Hawaii 96804



**HIGH TECHNOLOGY
DEVELOPMENT
CORPORATION**

Central Pacific Plaza, 220 South King Street, Suite 252
Telephone (808) 548-6986

Mailing Address: P.O. Box 2359, Honolulu, Hawaii 96804

GEORGE R. ARYOSHI
PRESIDENT
K. TIM YEE
CHAIRMAN
WILLIAM M. BASS, JR.
EXECUTIVE DIRECTOR



U.S. Department of Housing and Urban Development
Honolulu Area Office, Region IX
300 Ala Moana Blvd., Room 3318
Honolulu, Hawaii 96850

August 29, 1985

85-348

Solar Energy Research Institute
1617 Cole Boulevard
Golden, Colorado 80401

Attention: F. Blake/253

Gentlemen:

Subject: Draft Environmental Impact Statement-- Development Plan for the Hawaii Ocean Science & Technology Park and Proposed Expansion of the Natural Energy Laboratory of Hawaii at Keahole, North Kona, Hawaii

Thank you for your comments on the subject draft EIS. In answer to your specific concerns:

Page IV-24, paragraph 4: The statement regarding little or no offshore trenching has been revised in the Final EIS to reflect the current trenching and backfill plans for the STF Upgrade project that you have stated in your letter.

Page II-23, Paragraph 4,5: The constraints of the sand channel apply only to coldwater pipes. There is room for the proposed coldwater pipes of the STF Upgrade project.

Figure II-13 and Figure 4-1 of Appendix B: No construction will be allowed in the airport "no-build" zone, other construction is subject to FAA Regulations, FAR 77.

Thank you for pointing out our typographical errors.

Sincerely,

William M. Bass, Jr.
William M. Bass, Jr.
Executive Director

cc: OFQC
LUC
County of Hawaii Planning Dept.
NELH
DPED, Energy Division

August 13, 1985

Ms. Letitia N. Uyehara, Director
Office of Environmental Quality Control
550 Halekauwila St., Room 301
Honolulu, HI 96813

Dear Ms. Uyehara:

SUBJECT: Draft EIS - Development Plan for Hawaii Ocean and Technology Park and Proposed Expansion of Natural Energy Laboratory of Hawaii

We have reviewed the Draft EIS that will provide scientific and research opportunities for the development of high technology enterprises related to the use of ocean-water.

We have no comments to add to our letter that responded to the EIS Preparation Notice on April 17, 1985.

We are returning the Draft EIS and find no need to receive a copy of the Final EIS.

Sincerely,

Calvin Lew
for Calvin Lew
Director
Community Planning and Development Division, 9.2C

cc:
W. M. Bass
M. C. Metz



United States Department of the Interior

FISH AND WILDLIFE SERVICE

300 ALA MOANA BOULEVARD
P O BOX 50167
HONOLULU, HAWAII 96850

IN REPLY REFER TO
ES
Room 6307

Letitia M. Uyebara, Director
Office of Environmental Quality Control
550 Halekaunila Street
Room 301
Honolulu, Hawaii 96813

AUG 2 2 1985

Re: Draft Environmental Impact Statement - Development Plan for
Hawaii Ocean Science and Technology Park and Proposed
Expansion of Natural Energy Laboratory of Hawaii, Keahole,
North Kona, Hawaii

Dear Ms. Uyebara:

The U.S. Fish and Wildlife Service has reviewed the referenced document and offers the following comments for your consideration.

As discussed in the Draft EIS, the on-land disposal of approximately 20 - 144 mgd of sea water would increase the salinity of groundwater in the area. This change in groundwater would affect the water quality characteristics of the anchialine ponds in the project area and may eventually turn them into marine tidal pools. The Draft EIS states that it would "be easy to artificially create new anchialine ponds by digging pits to intersect the water table at nearshore locations out of the zone of impact of the seawater return flow."

Anchialine ponds are not simply holes in lava fields containing brackish water. Anchialine ponds support complex algal communities and populations of native shrimps. It is not known how successful the construction of artificial anchialine ponds would be. The Service recommends that the disposal of seawater be done to minimize the impacts on anchialine ponds.

The EIS should also include a more complete description of the secondary entrainment of fish larvae and eggs by the return plumes. The transport of warm-water fish larvae and eggs into deep cold water may have a significant effect on local fisheries.

The EIS should discuss the measures and policies that would prevent the accidental release and establishment of non-native species in local waters. As the project increases in scope, the potential for accidentally introducing alien species increases.

The Service recommends that a monitoring program to detect changes in water quality and nearshore biota attributable to the discharge of mariculture-generated seawater be conducted.

We appreciate the opportunity to comment.

Sincerely,

for Ernest Kosaka
Project Leader
Office of Environmental Services

cc: NMFS - WPPO
EPA, San Francisco
DLNR
DAR
High Technology Development Corporation
The Traverse Group, Inc.





HIGH TECHNOLOGY DEVELOPMENT CORPORATION

Central Pacific Plaza 220 South King Street, Suite 252
 Telephone (808) 548-8956

GEORGE R. ARYOSHI
 GOVERNOR
 K. TIM YEE
 COMMISSIONER
 WILLIAM M. BASS, JR.
 EXECUTIVE DIRECTOR

Mailing Address: P.O. Box 2359, Honolulu, Hawaii 96804

August 29, 1985

Mr. Ernest Kosaka
 Project Leader
 U.S. Dept. of the Interior
 Fish and Wildlife Service
 Office of Environmental Services
 P.O. Box 50167
 Honolulu, Hawaii 96850

Dear Mr. Kosaka:

Subject: Draft Environmental Impact Statement-- Development Plan for the Hawaii Ocean Science & Technology Park and Proposed Expansion of the Natural Energy Laboratory of Hawaii at Keahole, North Kona, Hawaii

Thank you for your comments on the subject draft EIS. In answer to your specific concerns:

Paragraphs 2 and 3: Anchialine ponds represent sea-level exposures of subterranean water combining both seawater and seaward percolating fresh water. The physical characteristics which are primarily responsible for creating an unusual ecosystem are 1) clear waters having a rapid turnover (every tidal cycle, and 2) low salinity. Where these conditions are present--usually in geologically-recent, low-elevation lavas or raised limestone--excavated ponds (AECOS, 1980, Field Reconnaissance of the Ruddle Property and Adjacent Marine Areas South of Puako, Hawaii, Tech. Rept. No. 286.) or wells (AECOS, 1977, Biological and Biochemical Investigations on Water Samples from Kahuku Seafood Plantation, Tech. Rept. No. 143.) are likely to develop anchialine ecosystems. Suitable conditions for creating new anchialine environments are ubiquitous along the South Kohala-North Kona coast, indicating that there are many potential pond sites. In its comment letter the State Department of Health indicates that such pond creation is currently being considered at Waikoloa Resort.

Paragraph 4: There is a potential for impact on the larval fish present in ambient water as they become entrained into the discharge plume of the colder effluent water. This "secondary

Mr. Ernest Kosaka
 August 29, 1985
 Page 2

entrainment" would occur over a narrow range of depth because of a rapid dilution of the effluent water. Because of the desire to avoid recirculation of effluent back into warm-water intakes, the design depth for the OTEC discharge off Keahole is about 200 feet (approx. 60 m.). Moreover, secondary entrainment of organisms would occur within a few meters of depth range, as the effluent is diluted from the depth of discharge to the bottom of the mixed layer.

Paragraph 5: The effect of non-indigenous tropical and sub-tropical species would be a function of the organism trophic level and the nature and composition of the native species within the Hawaiian nearshore ecosystem. The importation of all non-indigenous species is controlled by a multi-tier review and permit system administered by the Plant Quarantine Branch of the State Department of Agriculture. To date, all non-indigenous species cultured at NELH have undergone such a screening process and must comply with "conditions" mandated by the permit to be lawfully allowed into and maintained in the State.

The cold-water resources at Keahole Point have demonstrated many advantages for the cultivation of temperate water species such as abalone, kelp, trout, salmon, Maine lobster and oyster. At the same time, the very nature of temperate water species would, in most instances, prevent the establishment of such species in Hawaiian waters. Hawaii's warm, oligotrophic, surface waters pose as a natural barrier for many commercially valuable temperate water species. We suggest that the catastrophic release of temperate species in Hawaii's warm oligotrophic waters would eventually prove fatal to most species. Warm water species, not native to Hawaii, will be cleared with the State Department of Agriculture and necessary enforcement measures will be taken.

Paragraph 6: We concur in your recommendation for a water quality monitoring program. Such a program is under development at the present time.

Sincerely,

William M. Bass, Jr.

cc: OEOC
 LUC
 County of Hawaii Planning Dept.
 NELH
 DPED, Energy Division



United States Department of the Interior

GEOLOGICAL SURVEY

Water Resources Division
P.O. Box 50166
Honolulu, Hawaii 96850

July 31, 1985

Ms. Letitia N. Uyehara, Director
Office of Environmental Quality Control
550 Halekauihala Street
Room 301
Honolulu, Hawaii 96813

Subject: Draft EIS - High Technology Development Corporation,
Development Plan for the Hawaii Ocean Science &
Technology Park & Expansion of the Natural Energy
Laboratory of Hawaii, Keahole, North Kona, Hawaii

Tid
Dear Ms. Uyehara:

The subject draft EIS was reviewed by our staff. Please note that our comments, attached hereto, are limited to Appendix C dealing with our area of expertise.

We appreciate the opportunity to review the document and trust that our comments will be helpful. We are returning the EIS as requested.

Sincerely,

Stanley F. Kapustka
District Chief

Attachment

Enclosure

cc: Mr. William M. Bass, Jr., High Technology Development Corp., Hawaii
Ms. Marilyn C. Metz, The Traverse Group, Inc., Hawaii

fy

Our review comments are limited to Appendix C:

Page	Topic	Comments
1	General Hydrology	None.
1	Geology	None.
3	Ground-water occurrence and aquifer characteristics	Is the seawater return flow being injected, much colder and much more saline than the brackish water in the underlying lens? If so, this should be addressed. Also, if this is true, why wouldn't the injected water sink below the brackish water into the underlying seawater and out of the brackish water flow field.
6	Current disposal method ...	None.
7	On-land ocean water disposal	Same as above in Ground-water occurrence ...
8	Shallow surface trench disposal	Do. Do.
10	Deep well disposal	
11-14	Effects of on-land ocean water disposal	Coastal outflow is likely much less than 6.3 mgd per mile as reported by Kanehiro and Peterson (1977). This 6.3 mgd per mile figure was computed from a drainage area at least 10 times that of the Keahole area.

Hydraulics of on-land ocean water disposal

22	1a	6.3 mgd per mile is too high.
22-25	2-5	No comment.
26-27	6	Equation 8. What happened to π? Equation 9. Should read r ³ .



HIGH TECHNOLOGY DEVELOPMENT CORPORATION

Central Pacific Plaza, 220 South King Street, Suite 252
Telephone (808) 546 6936

GEORGE R. ARIYOSHI
GOVERNOR
K. TIM YEE
CHAIRMAN
WILLIAM M. BASS, JR.
EXECUTIVE DIRECTOR

Mailing Address P.O. Box 2359 Honolulu, Hawaii 96804

August 27, 1985

Mr. Stanley F. Kepustka
District Chief
U.S. Department of the Interior
Water Resources Division
P.O. Box 50166
Honolulu, Hawaii 96850

Dear Mr. Kepustka:

Subject: Draft Environmental Impact Statement — Development Plan for the Hawaii Ocean Science & Technology Park and Proposed Expansion of the Natural Energy Laboratory of Hawaii at Keahole, North Kona, Hawaii

Thank you for your comments on Appendix C of the subject Draft EIS. The responses which follow have been provided by Dames & Moore, the authors of that Appendix. Pages 3, 7, 8 & 10: As stated on pages IV-39, IV-40, and IV-101 of the draft EIS, the seawater return flow will be colder and more saline than the brackish water lens. The higher density of the seawater return flow results in a hydraulic tendency for the injected seawater to sink. However, the hydraulic heads induced by the application of large quantities of seawater return would be more significant and would result in initial mixing with and subsequent displacement of the relatively small quantity of ambient groundwater flow.

Pages 11-14, 22: The value of 6.3 mgd per mile of coastline as the groundwater flux may be an overestimate, but the analysis indicates the flux would be displaced and disrupted by the quantity of injection. A lesser flux would be more easily displaced and disrupted. The actual groundwater flux probably lies between 2 and 5 mgd per mile of coastline, and using this range of values would have little effect on the results of the analysis.

Mr. Stanley F. Kepustka
August 27, 1985
Page 2

Pages 26-27: Corrections to the printed equations have been made and will appear in the revised version of the report which will be appended to the Final EIS.

Your interest in this project and comments on the draft EIS are appreciated.

Very truly yours,

William M. Bass, Jr.
Executive Director

WMB/st

cc: OEOC
Land Use Commission
County of Hawaii Planning Dept.
NELH
DPED Energy Division



DEPARTMENT OF THE NAVY
HEADQUARTERS
NAVAL BASE PEARL HARBOR
BOX 110
PEARL HARBOR, HAWAII 96860-5020

IN REPLY REFER TO
9510
SER 002B/1411
5 AUG 1985

Ms. Letitia N. Uyehara, Director
Office of Environmental Quality Control
550 Halekaunila Street, Room 301
Honolulu, Hawaii 96813

Dear Ms. Uyehara:

DRAFT ENVIRONMENTAL IMPACT STATEMENT
DEVELOPMENT PLAN FOR HAWAII OCEAN SCIENCE & TECHNOLOGY PARK AND
PROPOSED EXPANSION OF NATURAL ENERGY LABORATORY OF HAWAII

The Draft EIS for the Development Plan for Hawaii Ocean & Science
Technology Park and Proposed Expansion of Natural Energy Laboratory of Hawaii
has been reviewed and we have no comments to offer. Since we have no further
use for the EIS, the EIS is being returned to the Office of Environmental
Quality Control, by copy of this letter.

Thank you for the opportunity to review the Draft EIS.

Sincerely,

HENRY J. RINNERT
Captain, CEC, U. S. Navy
Facilities Engineer
By direction of the Commander

Enclosure

Copy to:
Mr. William M. Bass, Jr.
High Technology Development Corporation
Central Pacific Plaza, Suite 252
220 South King Street
Honolulu, Hawaii 96813

Ms. Marilyn C. Metz
The Traverse Group, Inc.
P. O. Box 27506
Honolulu, Hawaii 96827

Office of Environmental Quality Control



U.S. Department
of Transportation
Federal Aviation
Administration

August 2, 1985

Ms. Letitia N. Uyehara, Director
Office of Environmental Quality Control
550 Halekaunila Street, Room 301
Honolulu, Hawaii 96813

Dear Ms. Uyehara:

We have reviewed the Draft EIS - Development Plan for HOST Park and
Proposed Expansion of NELH at Keahole, North Kona, Hawaii. We have no
comments on the Draft EIS, but thank you for the opportunity to review it.

Sincerely,

DAVID J. MELHOUSE
Planning Engineer

Henry A. Sumida
Airports District Office Manager

CC:
William M. Bass, Jr.
Marilyn C. Metz



U.S. Department
of Transportation
United States
Coast Guard

Prince Kalanianaʻolaha
Federal Building
300 Ala Moana Blvd.
Honolulu, Hawaii 96850
Phone: (808) 546-2861

Commander (S-1)
Fourteenth Coast Guard District

16475
Serial No. 5/170
01 Aug 1985

Ms. Letitia N. Uyebara, Director
Office of Environmental Quality Control
550 Halekauwila St., Room 301
Honolulu, Hawaii 96813

Dear Ms. Uyebara:

The Fourteenth Coast Guard District has reviewed the DRAFT ENVIRONMENTAL IMPACT STATEMENT for the DEVELOPMENT PLAN FOR HAWAII OCEAN SCIENCE AND TECHNOLOGY PARK and PROPOSED EXPANSION OF NATURAL ENERGY LABORATORY OF HAWAII and has no objection or constructive comments to offer at the present time.

Sincerely,

J. F. MILBRAND
Commander, U. S. Coast Guard
District Planning Officer
By direction of Commander,
Fourteenth Coast Guard District

Copy: Mr. William M. Bass, Jr.



STATE OF HAWAII
DEPARTMENT OF ACCOUNTING AND GENERAL SERVICES
P. O. BOX 116, HONOLULU, HAWAII 96810

AUG 22 1985

HIDEO MURAKAMI
COMPTROLLER
MIKE N. TOKUNAGA
DEPUTY COMPTROLLER

LETTER NO. (P) 1475.5

Ms. Letitia Uyehara
Page 2
Ltr. No. (P) 1475.5

Ms. Letitia Uyehara, Director
Office of Environmental Quality Control
550 Halekauwila Street, Rm. 301
Honolulu, Hawaii 96813

Dear Ms. Uyehara:

Subject: Draft EIS-Development Plan for Hawaii Ocean
Science and Technology Park and Expansion of
the Natural Energy Laboratory of Hawaii
Keahole, North Kona, Hawaii

We have reviewed the subject draft EIS and have the
following comments to offer:

1. Page II-9 Second Paragraph

Revise the second sentence to read as follows:
"Basic to all scenarios is the initial improve-
ments phase (FY 1985-86) if available funds are
adequate." The scope of the initial improvements
phase will depend on the funds currently
available.

2. Page IV-35 Last Paragraph

Revise the first sentence to delete the word
"pre-treated." The need to pre-treat the used
ocean water will depend on the quality of the
ocean water being disposed. The requirement for
pre-treating will be covered in the Development
Rules for HOST Park, which will be adopted after
public hearing.

3. Page IV-40 Paragraph 3.4.4. Recommendations

We recommend that this section include a discus-
sion on locating the seawater disposal trenches at
three different locations and elevations along the
NELH access road for the following reasons:

1. The volume of cold seawater and warm seawater may require a large disposal pipe or numerous smaller pipes over a substantial distance to the one trench disposal area. Both of these solutions appear too costly and impractical.
2. The installation of three strategic monitoring locations should detect possible adverse environmental effects of the seawater return system before occurrence of serious consequences.

Thank you for the opportunity to comment on the draft EIS. If there are any questions, please have your staff contact Mr. Ralph Yukumoto on 548-5703.

Very truly yours,

HIDEO MURAKAMI
State Comptroller



HIGH TECHNOLOGY DEVELOPMENT CORPORATION

Central Pacific Plaza, 220 South King Street, Suite 252
Telephone (808) 548-8966

GEORGE R. ARIYOSHI
GOVERNOR
K. TIM YEE
COMMISSIONER
WILLIAM M. BASS, JR.
DIRECTOR
RELATIVE DIRECTOR

Mailing Address: P.O. Box 2359, Honolulu, Hawaii 96804

August 29, 1985

MEMORANDUM

TO: The Honorable Hideo Murakami
State Comptroller

THROUGH: Mr. Kent M. Keith
Director of Planning and Economic Development

FROM: William M. Bass, Jr. *William M. Bass, Jr.*

SUBJECT: Draft Environmental Impact Statement-- Development
Plan for the Hawaii Ocean Science & Technology Park
and Proposed Expansion of the Natural Energy
Laboratory of Hawaii at Keahole, North Kona, Hawaii

Thank you for reviewing and commenting on the subject draft
EIS. In response to your specific comments:

1. Page II-9, Second Paragraph: The sentence has been revised as you have requested.
2. We cannot delete the word "pre-treated" because, in some cases, such treatment could be extremely important in ensuring the maintenance of the quality of the receiving waters. Recognizing the fact that for MOST Park, the requirement will be covered in the pending Development Rules, the statement has been revised to read as follows: "...seawater return flows (pre-treated if necessary to meet water quality standards) are..."
3. The distances selected for analyses were based on probable average injection points, recognizing that injection could occur at various locations and elevations due to considerations such as proximity to use points. We strongly urge, however, that injection does not occur closer than 1,000 feet from the shoreline. We concur that the installation of three strategic monitoring locations should detect possible adverse environmental effects of the seawater return system before occurrence of serious consequences.

The Honorable Hideo Murakami
August 29, 1985
Page 2

We look forward to our continued association with your department in the planning, design and construction of this unique development.

cc: OEQC
LUC
County of Hawaii Planning Dept.
NELH
DPEB, Energy Division

GEORGE R. ARIYOSHI
GOVERNOR



JACK K. SUWA
CHAIRPERSON, BOARD OF AGRICULTURE
SUZANNE D. PETERSON
DEPUTY TO THE CHAIRPERSON

State of Hawaii
DEPARTMENT OF AGRICULTURE
1428 So. King Street
Honolulu, Hawaii 96814
August 21, 1985

Mailing Address:
P. O. Box 22159
Honolulu, Hawaii 96822

MEMORANDUM

To: Ms. Letitia N. Uyehara, Director
Office of Environmental Quality Control

Subject: Draft Environmental Impact Statement (EIS)
Development Plan for Hawaii Ocean Science and
Technology Park and Proposed Expansion of Natural
Energy Laboratory of Hawaii
TMK: 7-3-09: por. 5
7-3-48: por. 3
7-3-43: 3, 4, 5
Keahole, North Kona, Hawaii
Acres: 547

The Department of Agriculture has reviewed the subject
Draft EIS and finds that the concerns found in our letter of
April 4, 1985 (copy enclosed) have been adequately addressed.

Thank you for the opportunity to comment.

Jack K. Suwa
JACK K. SUWA
Chairman, Board of Agriculture

Attachment

cc: High Technology Development Corporation
The Traverse Group, Inc.

III 7-3-09: por 5

2/1/85
[Handwritten initials]

(TMK 7-3-09: por 5
7-3-43: por 3)

April 4, 1985

Mr. William M. Bass, Jr.
High Technology Development Corporation
Central Pacific Plaza, Suite 252
220 South King Street
Honolulu, Hawaii 96313

Dear Mr. Bass:

Subject: Environmental Impact Statement (EIS) Preparation
Notice for the Development Plan for the Hawaii Ocean
Science and Technology Park and Proposed Expansion of
the Natural Energy Laboratory of Hawaii at Ke-ahole,
North Kona, Hawaii

The Department of Agriculture has reviewed the subject EIS Prepara-
tion Notice and offers the following comment.

The EIS should indicate the projected domestic water demand for
the proposed project, and whether existing and proposed domestic water
sources are sufficient to meet the needs of all water uses, including
agriculture, in the affected area.

We appreciate the opportunity to comment.

Sincerely,

Jack K. Suwa
JACK K. SUWA
Chairman, Board of Agriculture

cc: DPED
Ms. Marilyn C. Metz, Traverse Group, Inc.



**HIGH TECHNOLOGY
DEVELOPMENT
CORPORATION**

Central Pacific Plaza, 220 South King Street, Suite 252
Telephone (808) 548-8996

GEORGE R. ARIYOSHI
GOVERNOR

K. TIM YEE
CHAIRMAN

WILLIAM M. BASS, JR.
EXECUTIVE DIRECTOR

Mailing Address P O Box 2359 Honolulu, Hawaii 96804

August 27, 1985

Mr. Jack K. Suwa
Chairman, Board of Agriculture
State of Hawaii Department of Agriculture
1428 So. King Street
Honolulu, Hawaii 96814

Dear Mr. Suwa:

Subject: Draft Environmental Impact Statement— Development Plan for the
Hawaii Ocean Science & Technology Park and Proposed Expansion
of the Natural Energy Laboratory of Hawaii at Keahole, North
Kona, Hawaii

Thank you for your comment that your concerns expressed in your letter of
April 4, 1985 had been adequately addressed in the draft EIS.

Sincerely,

William M. Bass, Jr.
William M. Bass, Jr.
Executive Director

WMB/st

cc: OBOC
Land Use Commission
County of Hawaii Planning Dept.
NELH
DPED Energy Division



**STATE OF HAWAII
DEPARTMENT OF DEFENSE
OFFICE OF THE ADJUTANT GENERAL**

340 DIAMOND HEAD ROAD, HONOLULU, HAWAII 96819-4495

GEORGE R. ARIYOSHI
GOVERNOR

HITENG

JUL 30 1985

Letitia N. Uyehara, Director
Office of Environmental Quality Control
550 Halekaiwila Street, Room 301
Honolulu, HI 96813

Dear Ms. Uyehara:

Development Plan for Hawaii Ocean Science and Technology Park
and Proposed Expansion of Natural Laboratory of Hawaii
Keahole, North Kona, Hawaii

Thank you for providing us the opportunity to review the above subject
development.

We have completed our review and have no comments to offer at this time.

Yours truly,

Jerry M. Matsuda
Jerry M. Matsuda
Major, Hawaii Air
National Guard
Contr & Engr Officer

Enclosure

cc: High Technology Development Corp.
The Traverse Group, Inc.



STATE OF HAWAII
DEPARTMENT OF SOCIAL SERVICES AND HOUSING
HAWAII HOUSING AUTHORITY

P. O. BOX 17807
HONOLULU, HAWAII 96817

July 31, 1985

Russell N. Fukumoto
RUSSELL N. FUKUMOTO
EXECUTIVE DIRECTOR

IN REPLY REFER

TO:

MEMORANDUM:

TO: Letitia N. Uyebara, Director
Office of Environmental Quality Control

FROM: Russell N. Fukumoto, Executive Director

SUBJECT: Draft Environmental Impact Statement- Development
Plan for Hawaii Ocean Science & Technology Park
and Proposed Expansion of Natural Energy Laboratory
of Hawaii

The Authority has reviewed subject draft EIS and has no comments to offer relative to the proposed action at this time.

Thank you for allowing us to comment on this matter.

Russell N. Fukumoto
Russell N. Fukumoto
Executive Director

CC: Mr. William M. Bass, Jr.
Ms. Marilynn C. Metz



STATE OF HAWAII
DEPARTMENT OF HEALTH

P. O. BOX 3378
HONOLULU, HAWAII 96801

August 21, 1985

MEMORANDUM

To: Ms. Letitia N. Uyebara, Director
Office of Environmental Quality Control

From: Deputy Director for Environmental Health

Subject: Draft Environmental Impact Statement (EIS) - Development Plan for Hawaii
Ocean Science & Technology Park and Proposed Expansion of Natural Energy
Laboratory of Hawaii, Keahole, North Kona, Hawaii

Thank you for allowing us to review and comment on the subject draft EIS. We provide the following comments.

Shellfish Sanitation

Shellfish sanitation requirements need to be addressed for the applicable type of aquaculture projects. They should comply with Chapter 35 of Title 11, Administrative Rules, Department of Health.

Surface Disposal of Wastewater

Aquatic developments, proposed by the H.O.S.T. Park, may be subject to one of the following NPDES regulations:

A. Aquaculture Projects

The EPA defines an aquaculture project as a managed water area in which "discharged pollutants" are used for the maintenance or production of harvestable freshwater, estuarine, or marine plants and animals. The State does not have delegation to issue this type of NPDES permit. Therefore, aquatic projects involving the use of wastewater sources would be directed to EPA.

B. Concentrated Aquatic Animal Production Facilities

A hatchery, fish farm, or other facility is a concentrated aquatic animal production facility if it contains, grows, or holds fish species or aquatic animals in ponds, raceways, or other similar structure which discharge at least 30 days per year. These operations are point sources subject to the State NPDES Program. Facilities that may be exempted from permit requirements include the following:

1. Cold Water Aquatic Animals (i.e., Salmon and Abalone):

- a. Facilities which produce less than 20,000 pounds harvest weight of aquatic animals per year; and
 - b. Facilities which feed less than 5,000 pounds of food during the calendar month of maximum feeding.
2. Warm Water Aquatic Animals (i.e., Prawn, Shrimp and Catfish):
- a. Closed ponds which discharge only during periods of excess runoff; or
 - b. Facilities which produce less than 100,000 pounds harvest weight of aquatic animals per year.

Specific permit requirements or exemptions will be reviewed by the Department on a case-by-case basis with respect to the water quality standards of the receiving water.

Subsurface Disposal of Wastewater

Even though the subject site is located in an area which has been designated as an exempted area under the Underground Injection Control (UIC) Program, the permitting of the injection wells will depend upon the quality and content of the wastes. If the wastewater will contain industrial wastes, close scrutiny will be required to assure that the wastes are not hazardous in accordance with 40 CFR 261. The disposal of wastes of this nature would result in the classification of the injection wells as Class IV wells which are prohibited under the State UIC Program.

This condition is also applicable to any individual disposal systems which may be proposed by the tenants.

Proposed Ocean Outfall

The proposed mixed-seawater (wastewater) discharge of 16,000 gpm (23 MGD) for the forthcoming OTEC experiments at NELH is subject to the above-mentioned surface disposal requirements. If the ocean outfall disposal is selected over on-land disposal for the full development flow of 183 MGD (HOST Park 144 MGD and NELH 39 MGD), these will also be subjected to the surface disposal requirements.

In accordance with the Administrative Rules (AR), of the Department of Health, Title II, Chapter 54, Water Quality Standards, the receiving water is classified as Class AA, which requires that these waters remain in their natural pristine state as nearly as possible with an absolute minimum of pollution or alteration by human activity. The beneficial uses shall be protected so in the strict interpretation and intent of the AR, no construction activity and disposal are desirable in Class AA waters.

Proposed On-Land Disposal

The on-land disposal of shallow surface trench and deep injection wells are being considered. Either on-land disposal method will affect the existing nature of the anchialine ponds which will violate conformance to the basic water quality criteria applicable to all waters as contained in Section II-54-04. According to the draft EIS, it was noted the anchialine ponds are "not of high natural value," which should be further addressed such as a comparison to other anchialine ponds in the vicinity.

At the Waikoloa Resort Development, artificially created anchialine ponds are being considered because of the proposed development and degradation of some of the existing anchialine ponds due to destructive human intrusion. As part of this consideration, very intense long-term bio-monitoring of the anchialine pond biota is proposed.

Another concern is the "leakage" of the harmful prophylactics for the control of disease that may be used in aquatic rearing facilities and the domestic sewerage that may enter the anchialine ponds. Pretreatment of some sort should be considered when necessary for each individual wastestream (prior to commingling), aside from dilution.

Class AA Water Status

For the waters along the NELH and HOST Park to remain a Class AA water and pristine for aquatic rearing purposes, it is recommended that stringent controls be developed, imposed and enforced on the tenants.

Please address air, water, solid wastes and sewage control commitments in the construction plans. We reserve the right to impose future environmental restrictions on the project at the time final plans are submitted to this office for review.

MELVIN K. KOIZUMI

cc: Mr. William M. Bass, Jr.
Ms. Marilyn C. Metz

HIGH TECHNOLOGY DEVELOPMENT CORPORATION

Central Pacific Plaza 220 South King Street Suite 252
Telephone (808) 548-6926

GEORGE R. ANYOSCH
CHAIRMAN
K. TIM YEE
PRESIDENT
WILLIAM M. BASS, JR.
EXECUTIVE DIRECTOR

Mailing Address P.O. Box 2359 Honolulu, Hawaii 96804

August 29, 1985

Mr. Melvin K. Koizumi
Deputy Director for Environmental Health
State of Hawaii Department of Health
P.O. Box 3378
Honolulu, Hawaii 96801

Dear Mr. Koizumi:

Subject: Draft Environmental Impact Statement-- Development
Plan for the Hawaii Ocean Science & Technology Park
and Proposed Expansion of the Natural Energy
Laboratory of Hawaii at Keahole, North Kona, Hawaii

Your comments on the subject draft EIS are appreciated. In
response to your specific concerns:

1. Shellfish Sanitation. We understand that shellfish
sanitation requirements must comply with Chapter 35 of Title II,
Administrative Rules, Department of Health. This will be done
for each shellfish species that will be cultured at HOST Park
and NELH. Compliance will be undertaken at the time a specific
request is made to produce this type of product on the subject
properties.

2. Surface Disposal of Wastewater.

A. There are no current plans to reuse wastewater for
aquaculture purposes.

B. NPDES permits will be applied for if there is an
aquaculture discharge into marine waters, such as an outfall.

3. Subsurface Disposal of Wastewater. At the present time,
trenches are the preferred method for on-land disposal of
seawater return flows. A UIC permit will be obtained if
injection wells are used. In any event, only seawater
(pretreated if necessary to protect water quality) will be
disposed of using this means. Disposal of industrial wastes is
being addressed in the Development Rules for the proposed HOST
Park. At the minimum, such wastes will be pretreated prior to

Mr. Melvin K. Koizumi
August 29, 1985
Page 2

disposal via septic tanks with leaching fields. We look forward
to DOH review of our criteria for disposing of wastes at HOST
Park and NELH. It is vital to the success of both NELH and Host
Park that the ocean-water resource not be compromised.

4. Proposed Ocean Outfall. We recognize the fact that both the
proposed OTEC outfall and on-land disposal of mariculture
seawater return flows will be subject to appropriate surface
disposal requirements. Ocean disposal will conform to the
provisions of Section 3.3 of the Water Quality Standards. No
zone of mixing will be required. As stated previously, it is
vital to the success of both NELH and HOST Park that the
ocean-water resource not be compromised.

5. Proposed On-Land Disposal. We have reviewed the basic water
quality criteria applicable to all waters which are contained in
Section 11-54-04, and do not believe any of the six stated
criteria would be violated. In most general terms, water in the
ponds would contain substances attributable to a controllable
source, and as a consequence, these waters could be subject to
such monitoring as the Director of the Department of Health may
prescribe. The DEIS recognizes this and a comprehensive water
quality monitoring program is anticipated.

The comparison of the anchialine ponds on the site with other
ponds in the vicinity is made on pages 7 and 8 of Appendix F.
Results from the monitoring program at the Waikoloa Resort that
you mentioned could be used to develop mitigation plans to
compensate for the loss of the anchialine ponds near Keahole
Point.

We agree with your recommendation concerning pretreatment prior
to commingling individual wastestreams. The need for
pretreatment will be evaluated on a case-by-case basis.
Recommendations are being incorporated into the Development
Rules for the project, and we will look to the Department of
Health for guidance in the development of appropriate controls
and their monitoring and enforcement.

6. Class AA Water Status. Stringent controls will be
developed, imposed and enforced on the tenants in order to
insure that the waters along the project remain Class AA. We
look forward to your input into these controls and the
monitoring and enforcement processes.

Mr. Melvin K. Koizumi
August 29, 1985
Page 3

Air, water, solid wastes and sewage control commitments will be addressed in the construction plans. We look forward to meeting with you and your staff for further coordination in the near future.

Sincerely,

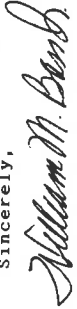

William M. Bass, Jr.
Executive Director

cc: OEQC
IUC
County of Hawaii Planning Dept.
NELH
DPED, Energy Division

GEORGE B. BENTON
GOVERNOR OF HAWAII



STATE OF HAWAII
DEPARTMENT OF LAND AND NATURAL RESOURCES
P O BOX 621
HONOLULU HAWAII 96809

AUG 22 1985

Ms. Letitia N. Uyehara, Director
Office of Environmental Quality Control
550 Halekaunila Street, Room 301
Honolulu, Hawaii 96813

Dear Ms. Uyehara:

We appreciate the opportunity to review the draft environmental impact statement (EIS) on the plan for development of the Hawaii ocean science and technology park (HOST) and for expansion of the natural energy laboratory. We have some concerns to express.

Historic Preservation

The draft EIS contains accurate information on the number of sites present and their locations and nature (IV-84-89; Archaeological Reconnaissance Surveys), the extent of archaeological work to date (IV-84,86-87), and the general nature of findings (IV-84, Item 1.1). It includes general significance assessments (IV-87,90; Item 1.4), and potential adverse impacts are more thoroughly discussed (IV-87,90). Proposed tasks to reduce these impacts (preservation and archaeological data recovery) are also covered in a more extensive fashion (IV-87,90).

However, we believe there are improvements that need to be made to upgrade the historic preservation assessments and to reduce adverse impacts. These are:

- 1) In the Final EIS, the map and text for the HOST Park area should be revised to include permanent site numbers. These numbers are available at our office.
- 2) In the Final EIS, the text under Part IV.6.1.2 should reference the prior archaeological surveys either in the text or a table; the text should not just say 8 and 7 surveys. This step fully references the prior work and enables the reader to better evaluate the extent of prior work as well as possibly go to the source material. A list of these references is available at our office.
- 3) We believe that mitigation measures need to be clearer and that adequacy checks by our office need to be specified. (Mitigation measures are covered here; adequacy checks are discussed in items 4 and 5.) Discussions with the preparer of the EIS make it apparent to our historic sites office that the intent to properly reduce adverse impacts on historic sites exists, but these items need to be clarified.

SUSUMU ONO, CHAIRMAN
HAWAIIAN LAND & NATURAL RESOURCES
EDGAR A. HAMASU
Secretary of the Department

DIVISIONS:
AGRICULTURE DEVELOPMENT
AQUATIC RESOURCES
CONSERVATION AND
RESOURCES ENFORCEMENT
FORESTRY AND WILDLIFE
LAND MANAGEMENT
STATE MARKS
WATER AND LAND DEVELOPMENT

Before any development (such as Phase 1) occurs, a) all sites to be preserved need to be specified and protected, and b) acceptable and detailed scopes of work for archaeological data recovery at certain sites need to be prepared. Essentially, this is a management (or mitigation) plan. The Draft EIS states a mitigation/management plan will be prepared (1-8, IV-87,90), but it says little about the plan.

We suggest a simple and clear historic preservation management plan be prepared for both the HOST Park and NELH. We have attached a brief discussion of what it should include, under two parts: Archaeological Data Recovery and Preservation (Attachment 1).

This plan need not be included in the Final EIS, as long as a commitment to complete it is included. However, all the sites to be preserved should be specified in the Final EIS, and a general summary of the nature of the plan should be included. We have attached a written example of the kind of statement that could be inserted in the Final EIS (Attachment 2).

4) To ensure adequacy of the plan, it is vital that the historic preservation management plan should be reviewed and approved by our historic sites office. This is particularly critical for the scope of work for the archaeological data recovery. The preparers of the EIS have stated informally that they will coordinate matters with the office, but a reference to formal review and approval should be included in the Final EIS.

5) It is also vital, once data recovery is concluded, that the archaeological work be reviewed by our historic sites office for adequacy. This can involve two steps to speed this project. One is to review a summary report of the field work after its completion. If it proves to be adequate, then construction can be officially allowed to proceed. The second step is to review a report of the laboratory analyses and interpretations. If the work is adequate, then data recovery work at the sites covered can be considered completed. This check is a common step in our review process, but it is best for it to be clearly stated in the Final EIS.

Note: Because this project is a State undertaking and because there is a tight time schedule, continual coordination with our historic sites office is important. Ideally, such coordination should occur before any steps become finalized in writing, so that any problems are resolved immediately. It was our understanding that such coordination was to occur, particularly prior to this draft EIS document; however, this has not occurred. If we had seen a draft of the text, we could have easily supplied the preparer with the information noted in items 1-5 above. We thus recommend closer coordination between the High Tech Development Corporation during the remainder of this project.

Water Reserves

It is noted that over 142,000 gallons per minute (gpm) of seawater will be used for high technology energy experiments and mariculture activities at full development of both facilities. We support and encourage the monitoring of the on-land disposal of this sea water to assess the effect on the ground-water aquifer of the area. We also note that the HOST Park has received a water commitment from the County Department of Water Supply for a maximum domestic water requirement of 400,000 gallons per day. The project's water requirement should therefore be closely coordinated with the County Department of Water Supply.

Wildlife

We suggest that project plans incorporate defensive measures against marauding waterbirds; in particular, the aukuu (black-crowned night heron).

Sincerely,

SUSUMU UNO
Chairperson

and
State Historic Preservation Officer

Attachments (2)

SUGGESTIONS FOR A
HISTORIC PRESERVATION MANAGEMENT PLAN

Part 1. Archaeological Data Recovery Plan.

This plan can serve as a scope of work for Phase 1 and later increments.

All sites that are not scheduled for preservation and that still contain unrecorded or unrecovered significant information should be listed, and the relevant information that needs to be recorded and/or recovered should be itemized for each site.

General procedures (methods) for field recovery should be spelled out, and the kinds of lab analyses and methods for lab analyses should be spelled out. Dating should particularly be a focus here.

The general kinds of interpretive analyses should also be spelled out. For example, at the site level we view dating the span of occupation and determining the function of the site at different time periods as critical interpretive elements. Subsistence exploitation and other commonly studied factors are also relevant. Importantly, data recovery must also consider the general history of human occupation in the Kaiaoa/Ooma land units (ahupua'a). Thus, at the conclusion of all data recovery work (or at incremental points), a reassessment of the history of these land units must occur based on the findings in the individually studied sites.

Part 2. Preservation Plan.

Sites that are to be preserved must be identified. Our recommendation that the Mamalahoa Trail and four examples of other site types (historic period permanent dwelling, prehistoric period permanent dwelling, cave, and C-shape) be preserved has been accepted in the Draft EIS (IV-90). The Mamalahoa Trail (IV-87) in the HOST Park and D16-5 through D16-11 in the NELH area (a set of historic period permanent dwelling sites) have been identified. But the prehistoric period permanent dwelling site, cave and C-shape still need to be selected in consultation with our office.

General plans for how these sites will be preserved need to be specified.

EXAMPLE OF POSSIBLE TEXT FOR FINAL EIS
ON MITIGATION OF HISTORIC SITES

1.3 Site Significance

The sites in the area are primarily significant for the information they contain on the prehistory and early history of the area. Despite looting, much information is still present in the sites. Architectural remains still stand, and archaeological excavations have shown that deposits with important information do exist in some sites.

1.4 Impact Producing Actions

The following actions, ... [as is on IV-87 in Draft EIS] ... shoreline areas.

These impacts may destroy or damage historic sites, and they might inadvertently increase looting through increased public access.

1.5 Mitigating Measures

Following the State Historic Preservation Office's recommendations, mitigation will focus on (1) preservation of excellent examples of different site types in the HOST and NELH areas and (2) on archaeological data recovery at sites where significant information is still unrecorded and/or unrecovered. All the sites meriting preservation and data recovery will be placed in protected "no build" zones until preservation or archaeological data recovery is concluded. Based on the Historic Preservation Office's comments, a number of sites in the HOST and NELH areas have already had their significant information recorded and/or recovered, and these need no further consideration.

A historic preservation management plan is being prepared to include the details for preservation methods and the details for methods and interpretations needed in the archaeological data recovery work. This plan is to be reviewed and approved by the State Historic Preservation Office before any preservation and data recovery work occur.

The State Historic Preservation Office recommended the preservation of one site (the Mamalahoa Trail) and four examples of other site types (a historic period permanent



HIGH TECHNOLOGY DEVELOPMENT CORPORATION

Central Pacific Plaza 220 South King Street, Suite 252
Telephone (808) 548-8996

Mailing Address P O Box 2359 Honolulu Hawaii 96804

GEORGE R. ARIYOSHI
GOVERNOR
K. TIM YEE
CHAIRMAN
WILLIAM M. BASS, JR.
EXECUTIVE DIRECTOR

August 29, 1985

MEMORANDUM

TO: The Honorable Susumu Ono
Chairperson of the Board of Land and Natural Resources

THROUGH: Mr. Kent M. Keith
Director of Planning and Economic Development

FROM: William M. Bass, Jr. *William M. Bass, Jr.*

SUBJECT: Draft Environmental Impact Statement-- Development Plan for the Hawaii Ocean Science & Technology Park and Proposed Expansion of the Natural Energy Laboratory of Hawaii at Keahole, North Kona, Hawaii

Thank you for reviewing and commenting on the subject draft EIS. In response to your specific comments:

1. The map and text for the HOST Park area were revised in the Final EIS to include permanent site numbers.
2. A list of prior archaeological surveys for the area, obtained from your office, will be incorporated into the Final EIS as Appendix I.
3. A general summary of the archaeological mitigation plan, including preliminary selections of sites to be preserved, has been incorporated into the Final EIS.
4. A statement to the effect that the management plan will be reviewed and approved by the historic sites offices has been incorporated into the Final EIS.
5. A statement to the effect that the archaeological work will be reviewed by the historic sites office for adequacy has also been incorporated into the final EIS. The archaeological mitigation work is now being coordinated through the Department of Accounting and General Services (DAGS). Either they or their consultant will be contacting you shortly.
6. We concur in both of your observations concerning monitoring of on-land disposal of seawater return flows and coordinating with the County of Hawaii on issues concerning potable water.

dwelling site, a prehistoric period permanent dwelling site, a cave used as a prehistoric period temporary-use shelter, and a C-shaped enclosure also used as a shelter). These are sites that serve as examples of Hawaiian adaptation to the environment. They proposed that HOST and MELH jointly select one excellent example of each type from either parcel for preservation. The following sites have been selected, and the State Historic Preservation has concurred with the selection:

1. The Mamalahoa Trail in the HOST Park.
2. D16-5 through D16-11, a set of historic period permanent dwelling sites, in the MELH area.
3. _____, a prehistoric period permanent dwelling site, in the _____.
4. _____, a cave shelter, in the _____ area.
5. _____, a C-shaped shelter, in the _____ area.

Again, detailed preservation approaches will be presented in the management plan and will be reviewed and approved by the State Historic Preservation Office.

The State Historic Preservation Office recommended archaeological data recovery at all sites still containing unrecorded or unrecovered significant information. This work is feasible given the small size of the sites and their shallow deposits and is desirable given the possibility of increased looting and development. Table 4-11 lists the sites needing data recovery work in the HOST and MELH parcels. The needed work includes detailed mapping and excavation at those sites with deposits. The management plan will specify the minimum field and lab methods needed and the minimum interpretive analyses needed. Interpretations will include site-specific dating and functional interpretations and a general reassessment of the history of this area's land units (the Kalaoa and Ooma ahupua'a) based on the site findings. The management plan and its scope of work for data recovery is to be approved by the State Historic Preservation Office before any data recovery work is conducted. The Historic Preservation Office will also evaluate the archaeological fieldwork for adequacy and provide a statement of adequacy before construction can proceed, and the Historic Preservation Office will evaluate the archaeological final report to ensure lab and interpretive analyses have been adequately covered. Only after this report is accepted by the Historic Preservation Office as adequate will the archaeological data recovery work be complete. [Note: The archaeological data recovery work may well proceed in increments in conjunction with development phases. The Historic Preservation Office has indicated that this approach is acceptable and that adequacy review can be by increments.]

4

The Honorable Susumu Ono
August 29, 1985
Page 2

7. We understand that the aukuu is causing problems with aquaculture operations on Oahu. We also understand that there is really no defense for this pest, other than covering ponds that contain mariculture animals. Because the type of mariculture envisioned for HOST and NELH is not anticipated to depend on pond culture to a great extent, we would hope that problems with the birds would be minimal. We will, however, inform prospective tenants of the problems occurring on Oahu so that they can take appropriate measures to ensure that their operations are protected. A provision that covers may be required for ponds has been incorporated into the development rules.

cc: OEQC
LUC
County of Hawaii Planning Dept.
NELH
DPED, Energy Division

GEORGE P. ABIYOSHI
GOVERNOR



LETITIA N. UYEMARA
DIRECTOR
TELEPHONE NO.
546-6915

STATE OF HAWAII
OFFICE OF ENVIRONMENTAL QUALITY CONTROL
550 MALEKAUWILA STREET
ROOM 301
HONOLULU, HAWAII 96813

August 7, 1985

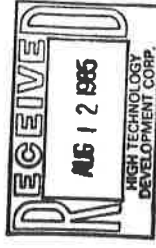

Mr. William M. Bass, Jr.
High Technology Development Corp.
Central Pacific Plaza
220 South King Street, Suite 252
Honolulu, Hawaii 96813

Dear Mr. Bass:

Subject: DEIS for the Hawaii Ocean Science and Technology
Park and Proposed Expansion of Natural Energy
Laboratory of Hawaii

We offer the following comments on the draft EIS for your consideration:

1. The area in which the ocean science and technology park and the natural energy laboratory are to be situated contains significant amounts of archaeological artifacts. We suggest that the Department of Land and Natural Resources' Historic Sites Division be consulted regarding the significance of the artifacts.
2. The anchialine ponds at Keahole should be preserved in light of the fact that many of the anchialine ponds on Hawaii are being destroyed or altered by development.
3. The importation of foreign species for aquaculture projects should be reviewed by the Board of Agriculture to insure that certain species will not become established in the state.



HIGH TECHNOLOGY DEVELOPMENT CORPORATION

Central Pacific Plaza 220 South King Street, Suite 252
Honolulu, Hawaii 96813
Telephone (808) 548-8996

August 27, 1985

Mailing Address: P.O. Box 2359, Honolulu, Hawaii 96804

GEORGE R. ARYOSHI
KIMIKO
K. T. YU
WILLIAM M. BASS, JR.
Executive Director

Mr. William Bass, Jr.
August 7, 1985
Page 2

Thank you for providing us the opportunity to review this EIS.

Sincerely,

Letitia N. Uyehara
Director

cc: Marilynn Metz-IGI, Inc.

Ms. Letitia Uyehara, Director
Office of Environmental Quality Control
550 Halekaula Street, #301
Honolulu, Hawaii 96813

Dear Ms. Uyehara:

Subject: Draft Environmental Impact Statement -- Development Plan for the Hawaii Ocean Science & Technology Park and Proposed Expansion of the Natural Energy Laboratory of Hawaii at Keahole, North Kona, Hawaii

Thank you for reviewing the subject draft EIS. In response to your specific comments:

1. The Department of Land and Natural Resources' Historic Sites Division was consulted concerning the significance of the archaeological remains on the project sites. Their recommendations were incorporated as mitigating measures in the draft EIS. An archaeological mitigation plan, based on these recommendations, has been incorporated into the detailed planning, design and construction work scopes for the development of HOST Park. Mitigation at NELH is or will be incorporated into each sublease and/or project agreement. In addition, the County of Hawaii Planning Department has indicated that recommended mitigation will be a condition of various development approvals.
2. As stated in the draft EIS, page IV-38, the ponds in the Keahole area were not classified as having high natural value by Maciolek and Brock in their study of the anchialine ponds along the Kona coast. Every precaution will be taken, however, not to destroy or alter them during construction activities.
3. We note your comment that importation of foreign species for aquaculture projects should be reviewed by the Board of Agriculture. Such a condition has been incorporated into the development rules for HOST Park and is currently being practiced at NELH.

Sincerely,

William M. Bass, Jr.

cc: Land Use Commission
County of Hawaii Planning Dept.
NELH
DPED Energy Division



**DEPARTMENT OF PLANNING
AND ECONOMIC DEVELOPMENT**

KAWAHAU BUILDING, 250 SOUTH KING ST., HONOLULU, HAWAII
MAILING ADDRESS: P.O. BOX 2359, HONOLULU, HAWAII 96804 • TELE: JU2020 H4P20

GEORGE R. ARYOSHI
DIRECTOR
KENT M. KEITH
DEPUTY DIRECTOR
MURRAY E. TOWILL
DEPUTY DIRECTOR
UNDA KAPUNIAI ROSEHILL
DEPUTY DIRECTOR

DIVISIONS
BUSINESS AND INDUSTRY DEVELOPMENT DIVISION
235 Kawaiaulu Drive, Honolulu, Hawaii 96804
235 Kawaiaulu Drive, Honolulu, Hawaii 96804
FOREIGN TRADE ZONE DIVISION
1000 Kalia Road, Honolulu, Hawaii 96813
LAND USE DIVISION
PLANNING DIVISION
RESEARCH AND ECONOMIC ANALYSIS DIVISION
OFFICES
ADMINISTRATIVE SERVICES OFFICE
INFORMATION OFFICE

Ref. No. P-2524

August 20, 1985

MEMORANDUM

TO: Ms. Letitia Uyehara, Director
Office of Environmental Quality Control

FROM: Kent M. Keith *Kent M. Keith*
Director
Office of Planning and Economic Development

SUBJECT: DEIS for the Hawaii Ocean Science and Technology (HOST) Park and
Expansion of the Natural Energy Laboratory of Hawaii (NELH),
Keahole, North Kona, Hawaii

We have reviewed the subject draft environmental impact (DEIS) statement and have the following comments.

The proposed HOST Park is situated on a 547-acre parcel of State-owned land. Figure III-4 of the DEIS shows privately-owned land to the south, Keahole Airport to the north and State-owned land to the east. The alternatives for expansion should be discussed in the EIS.

The Keahole area was selected for the HOST Park because of the unique features which the site offers. One of its most important features is the nutrient-rich, pathogen-free, cold ocean water pumped from the depths of 2,000 feet below sea level and located relatively close to shore. The EIS should more thoroughly discuss the measures that should be taken to protect the ocean resource from adverse impacts associated with further development of the Kona region. For example, adverse impacts could result from a deep ocean sewer outfall, if such a system is proposed.

Part I, Section 3.0, should be expanded to include more information on the criteria for tenant selection.

Thank you for the opportunity to review and comment on the subject document.

cc: Mr. William A. Bass, Jr.
High Technology Development Corporation
Ms. Marilyn C. Metz
The Traverse Group, Inc.



**HIGH TECHNOLOGY
DEVELOPMENT
CORPORATION**

Central Pacific Plaza, 220 South King Street, Suite 252
Telephone (808) 548-8996

August 29, 1985

Mailing Address: P.O. Box 2359, Honolulu, Hawaii 96804

GEORGE R. ARYOSHI
DIRECTOR
K. THOMPSON
DEPUTY DIRECTOR
WILLIAM A. BASS, JR.
EXECUTIVE DIRECTOR

MEMORANDUM

TO: The Honorable Kent M. Keith
Director of Planning and Economic Development

FROM: Bill Bass *Bill Bass*

SUBJECT: Draft Environmental Impact Statement (DEIS)--
Development Plan for the Hawaii Ocean Science &
Technology Park and Proposed Expansion of the Natural
Energy Laboratory of Hawaii at Keahole, North Kona,
Hawaii

Your review and comments on the DEIS for the HOST Park project are appreciated. The following information is provided in response to your specific comments:

1. It may be desirable to identify and acquire property for the expansion of the HOST Park should the need arise. At this time, however, the HOST Park requires various State and County permits before development can proceed, and there is not a certifiable demand to justify acquisition of additional acreage purely for HOST Park expansion. If other State priorities indicate that it is desirable to acquire lands in the vicinity of the airport for future uses, one of which might be expansion of HOST Park, then acquisition at this time might be appropriate.

2. Preserving the quality of the ocean waters off Keahole Point is of utmost importance to the success of both the HOST Park and NELH. Continuation of the stringent monitoring of these waters is planned to ensure that there is no pollution from the proposed County sewage outfall or any other source. Because of our concern, however, we have investigated the effects that a proposed sewage outfall in the vicinity of the project might have. The Department of Public Works, County of Hawaii, is in the process of designing a deep ocean outfall for the Kailua-Kona Sewage System. The most recent information we have is that the outfall will be located at the north end of the old Kona airport, farther to the south than anticipated in

The Honorable Kent M. Keith
August 29, 1985
Page 2

the original EIS for the project. Preliminary design and oceanographic baseline data collection are complete. The pipe will terminate in about 150 meters of water to ensure that the zone of mixing will be at least 1,000 feet from shore, and consequently, will be outside nearshore Class AA waters. According to the "Kona Ocean Outfall Application for Modification of Secondary Treatment Requirements for Discharge into Marine Waters" (R.M. Towill Corp. for County of Hawaii, 1982), the discharge will consist of 1.61 mgd of domestic wastes. The minimum dilution factor, without a diffuser, will be 85. Effluents would tend to rise from their discharge depth to no shallower than 30 meters. This would place the plume at depths between those anticipated for the HOST/NELH cold and warm water intakes. The distance between the proposed outfall project and the HOST/NELH sites, the flushing characteristics of the coastal waters in the area, and the documented lack of significant negative impacts on benthic and pelagic communities from comparable and larger ocean outfalls on Oahu, suggest the potential for adverse impacts on the HOST/NELH source waters are unlikely from this source.

3. At the present time we have no additional information on criteria for tenant selection. Development rules for HOST Park, however, are being written and additional criteria will be addressed there. These rules are subject to public hearing according to the State Administrative Procedures Regulations.

cc: OFQC
LUC
County of Hawaii Planning Dept.
NELH
DPED, Energy Division



University of Hawaii at Manoa

Water Resources Research Center
Holmes Hall 283 • 2540 Dole Street
Honolulu, Hawaii 96822

22 August 1985

Letitia N. Uyebara, Director
Office of Environmental Quality Control
550 Halekauwila Street, Room 301
Honolulu, Hawaii 96813

Dear Ms. Uyebara:

SUBJECT: Draft Environmental Impact Statement, High Technology Development Corporation Development Plan for the Hawaii Ocean Science and Technology Park and Expansion of the Natural Energy Laboratory of Hawaii, Keahole, North Kona, Hawaii

We have reviewed the subject DEIS and offer the following comments:

1. If HOST park is unable to desalinate water for its use, what will be the alternative source? Is there enough of it and what will be the environmental impact thereof?
2. In the absence of soil, septic tank leaching fields will not have effective biologic or mechanical filtering action for nutrient stripping. In light of the acknowledged nutrient contamination via current seepage, there is reason to challenge the performance of any proposed septic tank field.
3. Not addressed is the disposition of waste generated from cleaning the reverse osmosis unit as well as wet and dry laboratory chemical wastes. The handling of these materials differ from domestic sewage.
4. In an effort of this potential magnitude there should at least be a master plan for sanitary sewage disposal so that siting and planning of future construction can be coordinated toward that end. A private industrial park development would not be allowed to forego such an essential element of public health. A publicly owned research park should not be treated any differently because the basic issue remains the same, that of protecting public health.
5. Is there enough room for extending the Keahole airport runway in any eventuality within the confines of its existing boundary? Or to put it another way, will this park site ever be needed to extend the runway? That contingency needs to be considered because Keahole is bound to become a major airport in the future.

6. Evaporation can be expected to be high if the radiant budget is that suggested; however, the source of the Ansehoomse evaporation data is not given. Based on data that we are aware of from Waikoloa (washtub study) the estimate is 108 in/yr (Jan. 1976-0.24 in/day and July-0.4 in/day). Juvik's experimental data from Kawadhae suggests about 90 in. annually.
7. There is a considerable range in the annual solar radiation cycle, varying from 400 cal/cm²/day in January to 567 cal/cm²/day in July at Keahole Airport. Thus, there is about 25 percent less average radiation during the winter than in summer. Annual sunlight for Keahole is only about 5 percent more than Honolulu which averages 80 percent of the clear day value. Therefore, it seems likely that the 95 percent cloud free case is highly exaggerated. Long term value for Honolulu of about 500 cal/cm²/day x 1.04 would give 1919 BTU/ft² as a sunlit average for Keahole (Keahole = 1.04 x Honolulu solar).
8. Has the diurnal wind pattern been verified for Keahole? There are some interesting reports for the Kona coast and S. Kohala: Farwell, 1980 MS thesis; Schroeder, T.A., 1980, University of Hawaii Meteorology Dept. 79-05. The position of the sea breeze front has many implications for local weather at the site.
9. A better statement on rainfall might be that monthly rainfall is nearly constant throughout the year. See values for 68.3 Kona Airport and Fuelue 92.1.

Month	J	F	M	A	M	J	J	A	S
Sta 92.1	3.17	1.81	3.22	2.67	3.78	3.13	2.18	2.31	2.53
Sta 68.3	1.62	1.51	1.52	1.65	2.46	1.81	2.39	1.73	1.59
	O	N	D						
Sta 92.1	2.34	1.02	1.25						
Sta 68.3	1.20	1.18	1.11						

10. Has the high corrosion factor from spume generated by beach wave action been addressed?
11. Land disposal of heavier seawater and brine return flows have distinct unknown challenges to the existing basal lense system, particularly the added salinity to brackish water outflow along the coast as it affects marine ecology. Considering the long-term impacts that this park will have, it would be unfortunate if the land disposal method has been selected over ocean outfall as an expedience over the tedium of obtaining necessary permits. Ocean outfall needs to be seriously reconsidered, perhaps by a neutral third party taking into account all available reports and studies.

12. The Water Resources Research Center's report Proposed Prototype Testing Program, Land Disposal by Injection Wells of Ocean Water Effluent at Seacoast Test Facility, Keahole Point, Hawaii Island cited on p. 4 of References, needs additional information added, to wit: Report submitted to Lawrence Hallanger, Executive Director, Natural Energy Laboratory of Hawaii by L. Stephen Lau, Water Resources Research Center, 3 September 1980.

Thank you for the opportunity to comment. This material was reviewed by WRRC personnel.

Sincerely,

Edwin T. Marabayashi
Edwin T. Marabayashi
EIS Coordinator

ETM:jm

cc: W.M. Bass, Jr., HTDC
M.C. Metz, Traverse Group
Env. Center, UH



HIGH TECHNOLOGY DEVELOPMENT CORPORATION

Central Pacific Plaza 220 South King Street Suite 252
Telephone (808) 548-9956

GEORGE R. ARIYOSHI
GOVERNOR
K. TIM YEE
CHAIRMAN
WILLIAM M. BASS, JR.
EXECUTIVE DIRECTOR

Mailing Address P O Box 2359 Honolulu Hawaii 96804

August 29, 1985

Mr. Edwin T. Murabayashi
EIS Coordinator
University of Hawaii
Water Resources Research Center
Holmes Hall 283
2540 Dole Street
Honolulu, Hawaii 96822

Dear Mr. Murabayashi

Subject: Draft Environmental Impact Statement-- Development Plan
for the Hawaii Ocean Science & Technology Park and
Proposed Expansion of the Natural Energy Laboratory of
Hawaii at Keshole, North Kona, Hawaii

Thank you for reviewing and commenting on the subject
draft EIS. In response to your specific comments:

1. Potable Water Source. HOST Park has received a water commitment from the County of Hawaii for 400,000 gpd of potable water. This is discussed on pages IV-4 and IV-5 of the draft EIS. Desalination would be experimental, neither facility is depending on the results of these experiments for its necessary water. Because Kona is a water short area, it would be beneficial to the County if at some time in the future desalination proves feasible and the State could release its commitment.
2. Septic Tanks. Exception is taken to the suggestion that HOST Park is being treated differently than a private development. The HOST Park is undergoing every stage of State, County and public scrutiny that any private development would experience. The proposal to dispose of sewage by septic tanks for at least the first phase of development is based upon experience and economics. NELH presently uses septic tanks for sewage disposal with no noticeable adverse effects. As you are aware, nearshore nutrient levels are high all along the Kona coast, even where there are no sewage discharges, because of the high nutrient levels of the groundwater discharges. The main purpose of utilizing a septic tank system for future growth is

Mr. Edwin T. Murabayashi
August 29, 1985
Page 2

to provide for a more diffused discharge and to avoid the possibility of hitting a lava tube; it is recognized that the thin soil layer would provide little biological action. Further, the volume of the estimated sewage discharges would be very small compared to that of the seawater return, would tend to move mauka because of the shape of the plume, and would have a very long residence time. As noted throughout the document, the operation of both NELH and HOST facilities is dependent on clean ocean water. The method of sewage disposal adopted will have to meet criteria that is equal to or more stringent than that of the Department of Health.

3. Pretreatment will be required for all industrial wastes, including those from a reverse osmosis unit should one be installed. A plan for handling these types of waste is being incorporated into the Development Rules for the HOST project. These rules will be subject to a public hearing in accordance to the State Administrative Procedures Regulations.

A detailed master plan is being developed for the the HOST park. The sewage disposal system will be subject to the same regulations as a private development. We continue to emphasize that it is contrary to the interests of the HOST park to pollute its own intake water.

5. The Airports Division of the State DOT is leasing the land to HOST Park and has been a party to developing the boundary of the proposed parcel. The division was also consulted during the preparation of the EIS. Plans are for the airport to expand northward, and the division foresees no problem with HOST Park development.

6.-9. Thank you for the additional information on weather conditions in the Keshole area.

10. Corrosion is an important area of concern for all construction on the coastline, and will be considered in all construction specifications for HOST and NELH expansion.

11. The possible adverse impacts of the seawater return flows are important; this is why they have been discussed at length in the EIS. Ocean outfalls were not dismissed as an "expedience" and are still an option. The purpose of the monitoring program proposed in the draft EIS is to determine the effects of on-land disposal as the Park is developed so that changes can be instituted as necessary. The initial disposal flow from HOST Park is currently estimated to be approximately 6,000 gpm. Three monitoring wells are also planned for construction



HOUSE OF REPRESENTATIVES
THE THIRTEENTH LEGISLATURE

STATE OF HAWAII
STATI: CAPITOL
HONOLULU, HAWAII 96813

July 29, 1985

Speaker: HENRY HAAHEIHO PETERS
Vice-Speaker: MAKSIAHI K. IGE
Majority Leader: RICHARD A. KAWAKAMI
Minority Leader: TOMOYUKI KAMURA

DISTRICT REPRESENTATIVES

- 1st - ANDREW LEVIN
- 2nd - HARVEY S. TAJIRI
- 3rd - WAYNE METCALF
- 4th - DWIGHT Y. TAKAMINE
- 5th - VIRGINIA ISRIEL
- 6th - ROBERT K. LINDSEY
- 7th - MARK J. ANDREWS
- 8th - JEFFREY HONDA
- 9th - JOSEPH M. SODUKI
- 10th - HILL PETH
- 11th - DANIEL I. KIHANO
- 12th - RON MENOR
- 13th - ROBERT BUNDA
- 14th - JOSIE P. LUCING
- 15th - ROB NAKATA
- 16th - TIBRAHELEW H. TOMI
- 17th - MAKSIAHI K. IGE
- 18th - WHITNEY T. ANDERSON
- 19th - JOHN HUSTEN MEDERROS
- 20th - CAM CAVASSO
- 21st - DONNA R. IKIDALI
- 22nd - HAL JONES
- 23rd - BARIARA MARUMOTO
- 24th - ERIC HIRAKINGS, JR.
- 25th - CALVIN K. Y. SAY
- 26th - KIKI KIYABU
- 27th - BRIAN T. JANIGHCHI
- 28th - JAMES T. SHON
- 29th - DAVID M. DAGINO
- 30th - KUNAU ROYD KAMALITI
- 31st - RUSSELL REAR
- 32nd - MAZIE HIRONO
- 33rd - ROBT TAM
- 34th - MIKE ITO
- 35th - GALEN K. OMBIYE
- 36th - DWIGHT L. YOSHIMURA
- 37th - DENNIS M. NAKASATO
- 38th - RYUNALDO GRADUITY
- 39th - ROMY M. CATHOLA
- 40th - PINNA MERCADO KIM
- 41st - TOM OKAMURA
- 42nd - CLARICE Y. HASHIMOTO
- 43rd - ARNOLD MORGADO, JR.
- 44th - ELOISE YAMASHITA TUNGPALAN
- 45th - MITSUO "MITSU" SHITO
- 46th - PAUL T. OSHIRO
- 47th - MIKE CROZIER
- 48th - HENRY DAHLIO PETERS
- 49th - PETER K. AYO
- 50th - ALFRED C. LARDIZABAI
- 51st - RICHARD A. KAWAKAMI

Minority Leader
"Mamane" Akioe Lealea

Mr. Edwin T. Murabayashi
August 29, 1985
Page 3

immediately. The relatively low flow, and continual monitoring, will allow alternative disposal methods to be designed and employed if testing indicates that unforeseen significant adverse impacts will occur. Of particular importance to the success of the Park and NELH is the quality of the source waters. Monitoring data, therefore, will be subject to very conservative interpretation. It is entirely possible that a combination of trench disposal and ocean outfalls will be used as the Park develops incrementally. We believe, however, that sufficient safeguards are being incorporated into the proposed on-land disposal system to allow us to proceed with this less costly alternative. We have a responsibility to the taxpayers of the State to make sure that, after due consideration and evaluation of potential environmental effects, the most cost-effective infrastructure is constructed.

12. The references list will be corrected to add the additional information you request.

The level of detail of your review and thoroughness of your comments on the DEIS have been most beneficial. As the development proceeds, we would welcome your continued input, particularly on the design and implementation of the monitoring program.

Sincerely,

William M. Bass, Jr.
William M. Bass, Jr.

cc: OEQC
LUC
County of Hawaii Planning Dept.
NELH
DPED, Energy Division

William M. Bass, Jr.
Executive Director
High Technology Development Corp.
P. O. Box 2359
Honolulu, Hawaii 96804

Dear Mr. Bass:

Thank you for sending me a copy of the draft Environmental Impact Statement for the planned developments at the Hawaii Ocean Science Park and the expansion of the Natural Energy Lab at Keahole.

I appreciate your sharing the information and keeping me informed of the progress in developing this most vital project.

With warm personal regards:

Sincerely,
Wayne Metcalf

WAYNE METCALF
Hawaii State Representative
Third District

WM:cb



HIGH TECHNOLOGY DEVELOPMENT CORPORATION

Central Pacific Plaza 220 South King Street Suite 252
Honolulu, Hawaii 96813
Telephone (808) 548-8996



GEORGE R. ARIYOSHI
GOVERNOR
K. TIM YEE
CHAIRMAN
WILLIAM M. BASS, JR.
EXECUTIVE DIRECTOR

Mailing Address P O Box 2359 Honolulu, Hawaii 96804

August 27, 1985

Honorable Wayne Metcalf
Hawaii State House of Representatives
State Capitol, Room 325
Honolulu, Hawaii 96813

Dear Representative Metcalf:

Subject: Draft Environmental Impact Statement -- Development Plan for
the Hawaii Ocean Science & Technology Park and Proposed Expansion
of the Natural Energy Laboratory of Hawaii at Keahole, North
Kona, Hawaii

Thank you for reviewing the subject draft EIS. We appreciate your
support of these important projects.

Sincerely,

William M. Bass, Jr.
William M. Bass, Jr.
Executive Director

WMB/st

CC: OEOC
Land Use Commission
County of Hawaii Planning Dept.
NELH
DPED Energy Division

Dante K. Carpenter
Mayor

Eugene N. Tiwanak
Managing Director



DEPARTMENT OF PARKS & RECREATION COUNTY OF HAWAII

August 21, 1985

Ms. Letitia Uyebara, Director
Office of Environmental Quality Control
550 Halekauwila Street, Room 301
Honolulu, HI 96813

Subject: Draft EIS - Development Plan for HOST
Park and Proposed Expansion of NELH

Although we have no adverse comments to offer on either
project, we strongly believe that an enforceable manage-
ment monitoring program should be developed to insure
that shoreline areas are not irretrievably destroyed by
indiscriminate use (page vii).

Thank you for the opportunity to review the document
(which is being returned for your further use).

Pat Engelhard
Pat Engelhard
Director

PE:GM:ai

encls.

cc: Mr. William Bass
Ms. Marilyn C. Metz



**HIGH TECHNOLOGY
DEVELOPMENT
CORPORATION**

Central Pacific Plaza, 220 South King Street, Suite 252
Telephone (808) 548-8996

August 27, 1985

Mailing Address: P.O. Box 2359, Honolulu, Hawaii 96804

GEORGE R. ARYOSHI
GOVERNOR

K. TIM YEE
COMMISSIONER

WILLIAM M. BASS, JR.
EXECUTIVE DIRECTOR

**STATE OF HAWAII
OFFICE OF ENVIRONMENTAL QUALITY CONTROL**

500 MALEKAUNUA ST
ROOM 301
HONOLULU, HAWAII 96813
PHONE 548-8915

MEMO TO FILE:

Item number 4 deleted upon request by Hugh Ono,
Chief Engineer, County of Hawaii, on 8/21/85.
See attached letter of 8/19/85.

Ms. Patricia G. Engelhard
Director
Department of Parks & Recreation
County of Hawaii
25 Aupuni Street
Hilo, Hawaii 96720

Dear Ms. Engelhard:

Subject: Draft Environmental Impact Statement -- Development Plan for the
Hawaii Ocean Science & Technology Park and Proposed Expansion of
the Natural Energy Laboratory of Hawaii at Keahole, North Kona,
Hawaii

Thank you for reviewing the subject draft EIS. We agree that an
enforceable management monitoring program will have to be developed for
the reasons that you mention. The HTDC has requested a meeting with
representatives from the State Department of Land and Natural Resources
in order to discuss this situation. We will keep the County of Hawaii
informed of our progress on this matter.

Sincerely,

William M. Bass, Jr.
Executive Director

WMB/st

cc: OEGC
Land Use Commission
County of Hawaii Planning Dept.
NELH
DFED Energy Division



DEPARTMENT OF PUBLIC WORKS

COUNTY OF HAWAII 25 AUPUNI STREET HILO HAWAII 96720 TELEPHONE (808) 961 8321

HUGH Y. ONO
Chief Engineer
BRUCE C. METZ
Deputy Chief Engineer

August 19, 1985

MS LETITIA N UYEHARA DIRECTOR
OFFICE OF ENVIRONMENTAL QUALITY CONTROL
550 HALEKAUWILA STREET ROOM 301
HONOLULU HI 96813

SUBJECT: Draft Environmental Impact Statement
Applicant: State of Hawaii/DPED
Location: Keahole, North Kona, Hawaii
TMK : 7-3-09: 5 (Por); 7-3-43: 3 (Por.)

We have revised our August 6, 1985 letter as bracketed below.

We have reviewed the subject document and notice and our comments are as follows:

1. All development generated runoff shall be disposed on site and shall not be directed toward any adjacent properties. This would include individual property development.
2. In conformance with Chapter 27 of the Hawaii County Code a 100-year flood study would have to be conducted for the existing 96" pipe culverts when the property is subdivided.
3. On-site traffic concerns, although typically not addressed in an EIS, is beginning to become a problem in other similar developments. The most prevalent being the improper use of a street for back-up space, parking and loading and unloading.

*Deleted upon request by Hugh Y. Ono
Chief Engineer, County of Hawaii
8/21/85*

Hugh Y. Ono
HUGH Y. ONO
Chief Engineer

cc: Mr. William M. Bass, Jr.
Ms. Marilyn C. Metz



HIGH TECHNOLOGY DEVELOPMENT CORPORATION

Central Pacific Plaza, 220 South King Street, Suite 252
Honolulu, Hawaii 96804
Telephone: (808) 548-8996

GEORGE R. ARYOSHI
Governor
K. TIM YEE
Chancellor
WILLIAM M. BASS, JR.
Executive Director

Mailing Address: P.O. Box 2359 Honolulu, Hawaii 96804

August 29, 1985

Mr. Hugh Y. Ono,
Chief Engineer
Department of Public Works
County of Hawaii
25 Aupuni Street
Hilo, Hawaii 96720

Dear Mr. Ono:

Subject: Final Environmental Impact Statement (FEIS) — Development Plan for the Hawaii Ocean Science & Technology Park and Proposed Expansion of the Natural Energy Laboratory of Hawaii at Keahole, North Kona, Hawaii

Thank you for reviewing the subject draft EIS. In response to your specific comments:

1. All development runoff will be disposed on site and not be directed toward any adjacent properties. The County of Hawaii will have an opportunity to review this matter during the P.U.D. and other development review processes.
2. Your comment on the requirement for a 100-year flood study for the 96 culverts is noted. Our engineering consultants, R. M. Towill, Inc., will be contacting you in the near future concerning this requirement.
3. On-site traffic concerns are being addressed in the detailed master planning phases of both projects. The County of Hawaii will have an opportunity to review this matter during various development review processes.

Sincerely,

William M. Bass, Jr.
William M. Bass, Jr.
Executive Director

cc: OEQC
Land Use Commission
County of Hawaii Planning Dept.
NELH
DPED Energy Division



DEPARTMENT OF WATER SUPPLY • COUNTY OF HAWAII

25 AUPUNI STREET • HILO, HAWAII 96720



HIGH TECHNOLOGY DEVELOPMENT CORPORATION

Central Pacific Plaza, 270 South King Street, Suite 252
Telephone: (808) 548-9996

Mailing Address: P.O. Box 2359, Honolulu, Hawaii 96804

GEORGE R. ARYOSHI, GOV. HON.
K. TIM YEE, CHAIRMAN
WILLIAM M. BASS, JR., EXECUTIVE DIRECTOR

July 30, 1985

August 27, 1985

Ms. Letitia N. Uyehara, Director
Office of Environmental Quality Control
550 Halekaunila Street, Room 301
Honolulu, HI 96813

HAWAII OCEAN SCIENCE AND TECHNOLOGY PARK
DRAFT - ENVIRONMENTAL IMPACT STATEMENT

Thank you for the opportunity to review the subject document.

We have no comments or objections to the draft. Our agency has been in contact with the project officials and consultants regarding water demands and water improvement requirements.

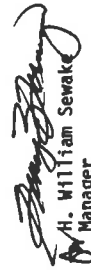
H. William Sewake
Manager

QA

cc - Mr. William M. Bass, Jr., High Technology Development Corporation
Ms. Marilyn C. Metz, The Traverse Group, Inc.

Mr. H. William Sewake
Manager
Department of Water Supply
County of Hawaii
25 Aupuni Street
Hilo, Hawaii 96720

Dear Mr. Sewake:

Subject: Draft Environmental Impact Statement — Development Plan for the Hawaii Ocean Science & Technology Park and Proposed Expansion of the Natural Energy Laboratory of Hawaii at Keahole, North Kona, Hawaii

Thank you for reviewing the subject draft EIS and stating that you have no objections or comments to the document. We will continue to work closely with your Department on all aspects of the proposed development that relate to potable water supply.

Sincerely,

William M. Bass, Jr.
Executive Director

cc: OEGC
Land Use Commission
County of Hawaii Planning Dept.
NELH
DPED Energy Division

... Water brings progress...

GEORGE R. ARIVOSHI
Chairman
K. TIM YEE
Chairman
WILLIAM M. BASS, JR.
President

HIGH TECHNOLOGY DEVELOPMENT CORPORATION

Central Pacific Plaza, 220 South King Street, Suite 252
Telephone (808) 548-8996

Mailing Address: P.O. Box 2359, Honolulu, Hawaii 96804



41

FRANCIS E. SMITH
FIRE CHIEF

DON COLOMA
DEPUTY FIRE CHIEF



HAWAII COUNTY FIRE DEPARTMENT
466 KINOOLE STREET, HILO, HAWAII 96720

DANTE K. CARPENTER
MAYOR

July 26, 1985

Ms. Letitia N. Uyehara, Director
Office of Environmental Quality Control
550 Halekauwila Street, Room 301
Honolulu, Hawaii 96813

Dear Ms. Uyehara:

We have reviewed the Environmental Impact Statement relative to development plans for the Hawaii Ocean Science and Technology Park at Keahole, North Kona, Hawaii.

Statements as presented in Section 3.3.1 and 3.3.2, page IV60, adequately address our concerns.

Thank you for the opportunity to comment.

Very truly yours,

Francis E. Smith
FRANCIS E. SMITH
FIRE CHIEF

FES/mo

cc: Mr. William M. Bass, Jr.
High Technology Development Corporation

Ms. Marilyn C. Metz
The Traverse Group, Inc.

Mr. Francis E. Smith
Chief
County of Hawaii Fire Department
466 Kinoole Street
Hilo, Hawaii 96720

Dear Chief Smith:

Subject: Draft Environmental Impact Statement -- Development Plan for the Hawaii Ocean Science & Technology Park and Proposed Expansion of the Natural Energy Laboratory of Hawaii at Keahole, North Kona, Hawaii

Thank you for reviewing the subject draft EIS. Your comment that the subject document (Page IV-60) adequately addresses your concerns is noted.

Sincerely,

William M. Bass, Jr.
William M. Bass, Jr.
Executive Director

cc: OFEC
Land Use Commission
County of Hawaii Planning Dept.
NELH
DPED Energy Division



DANTE K. CARPENTER
MAYOR

COUNTY OF HAWAII
OFFICE OF HOUSING AND COMMUNITY DEVELOPMENT

50 WAILUKU DRIVE • HILO, HAWAII 96720
PHONE: (808) 961-8378

A. SCOTT LEITHEAD
ADMINISTRATOR

Ms. Letitia Uyebara
August 14, 1985
Page 2

August 14, 1985

Ms. Letitia Uyebara
Office of Environmental
Quality Control
550 Halekauwila St., Rm 301
Honolulu, HI 96813

SUBJECT: Draft Environmental Impact Statement
Development Plan for the Hawaii Ocean Science Technology Park
and Expansion of the Natural Energy Laboratory of Hawaii
Keahole, North Kona, Hawaii

Thank you for this opportunity to review and comment on the draft Environmental Impact Statement (EIS) for the Development Plan for the Hawaii Ocean Science Technology (HOST) Park and Expansion of the Natural Energy Laboratory of Hawaii (NELH) at Keahole, North Kona, Hawaii.

The proposed HOST Park development and expansion of the MELH facility, when implemented, could result in the creation of 3,500 new jobs in West Hawaii over the next ten years, not including construction employment. This in turn will create a significant increase and demand for housing in the Kona district. In fact, the draft EIS estimates that between 119-280 new units would be required each year to accommodate the housing needs of the workers at the project site.

With respect to employee housing, the housing element of the Hawaii County General Plan states as a policy that: large industries which create a demand for housing shall provide employee housing based upon a ratio to be determined by an analysis of the locality's needs. This specific General Plan policy should be included as part of the discussion on the relationship of the proposed action to Land Use plans, policies, and controls for the affected area. Furthermore, Section 2.3 regarding population growth and housing should include further discussion as to how High Technology Development Corporation proposes to mitigate the employee housing needs.

The draft EIS on pages IV-57 and IV-58 includes discussion of some mitigating measures to address the impacts of the project on the employee housing market. Where the allocation of resources are required in the mitigating measures such as providing direct income supplements, the draft EIS should include a discussion as to the source of those resources.

In addition, the specific mitigating measure "provide, under the State Housing Program, housing at below market rents or prices" is inconsistent with the recommendation which is included as part of Appendix G. With respect to this mitigating measure, the draft EIS should also state that the housing aid could be provided under County and Federal programs as well.

In conclusion, we feel that the HOST development may have a significant impact on the overall housing market in the Kona area. The State of Hawaii must, therefore, be prepared to commit its resources to developing solutions to the employee housing impacts resulting from this project.

Again, thank you for this opportunity to provide our input on this very important project.

Sincerely,

A. Scott Leithead
Administrator

ASL/mab



EQUAL HOUSING OPPORTUNITY

HIGH TECHNOLOGY DEVELOPMENT CORPORATION

GEORGE R. ARIYOSHI
GOVERNOR
K. TIM YEE
CHAIRMAN
WILLIAM M. BASS, JR.
EXECUTIVE DIRECTOR

Central Pacific Plaza, 220 South King Street, Suite 252
Telephone: (808) 548-9956

Mailing Address: P.O. Box 2359 Honolulu, Hawaii 96804

August 29, 1985

Mr. A. Scott Leithhead
Administrator
Office of Housing and
Community Development
50 Wailuku Drive
Hilo, Hawaii 96720

Dear Mr. Leithhead:

Subject: Draft Environmental Impact Statement - Development
Plan for the Hawaii Ocean Science & Technology Park
and Proposed Expansion of the Natural Energy
Laboratory of Hawaii at Keahole, North Kona, Hawaii

Thank you for reviewing the subject draft EIS. In
response to your specific comments:

Paragraph 2: By way of clarification, the impacts
described in the draft EIS were developed for three scenarios.
Scenario A (most intensive aquaculture development) is regarded
as the most likely to occur since it is the scenario which is
based on development of the unique resource being provided. It
is the scenario being developed in the detailed planning and
design phases of the HOST project. Scenario A also has the
least housing impact. In addition, the impacts described in
the draft EIS are based on intensive development of the entire
park over a ten year period. As such, the impacts represent
the most extreme case of what could happen. It is anticipated
that the actual impacts will be substantially less than the
extreme case indicates. Given the possibility of adjustments
to the projections based on actual park uses, the impacts
should be carefully monitored. We suggest that your office be
the monitoring agency due to its proximity and awareness of
housing trends on the Big Island.

Paragraph 3: The relationship of the proposed action to
the County General Plan housing policy will be incorporated
into the final EIS as you suggest. In addition, discussions

Mr. A. Scott Leithhead
August 29, 1985
Page 2

are being held with the Hawaii Housing Authority to determine
what further actions the State can take to help mitigate any
potential housing problems. We will keep you informed as to the
progress of these meetings. A statement concerning the State's
response to the potential need for housing has been added to
section 2.3 of the final EIS.

Paragraph 4: Clarification will be added to the EIS
regarding the sources of resources for mitigating measures.
These resources are anticipated to come from the State General
Fund, General Obligation Bonds, and other project generated
funds.

Paragraph 5: As noted, the reference to providing land
at below market rents or prices was omitted from the body of
the report. This omission will be corrected. Also, the
possibility of providing housing aid under County and Federal
programs will be added to the EIS.

Paragraph 6: It is true that the HOST Park (and the
expansion of NELH) may have a significant impact on the overall
housing market in the Kona area, and that the State of Hawaii
should be prepared to commit resources to participate in
solutions to the employee housing impacts resulting from the
project. However, until the magnitude of the problem can be
more accurately projected, an appropriate strategy would be to
closely monitor the development and housing impacts, and
respond with mitigating measures to demonstrated needs. Our
ongoing discussions with the Hawaii Housing Authority and the
County are focused on ensuring that development of HOST Park
and expansion of NELH do not exacerbate the West Hawaii housing
situation.

I hope that this response adequately addresses your
concerns. Your review of the draft EIS and support of this
project are sincerely appreciated. I look forward to further
discussions with you on this matter.

Sincerely,

William M. Bass, Jr.

cc: OEQC
Land Use Commission
County of Hawaii Planning Department
NELH
DPED Energy Division



COUNTY OF HAWAII

the Travers Group

PLANNING DEPARTMENT

25 AUPUNI STREET • HILO, HAWAII 96720
(808) 961-8388

DANTE K. CARPENTER
Mayor

ALBERT LONO LYMAN
Director

ILIMA A. PILANAI
Deputy Director

August 21, 1985

Ms. Letitia Uehara, Director
Office of Environmental
Quality Control
550 Halekauiila Street, #301
Honolulu, HI 96813

Dear Ms. Uehara:

Draft EIS Development Plan
for Hawaii Ocean Science & Technology Park and
Proposed Expansion of Natural Energy Laboratory at Hawaii

Thank you for the reviewing opportunity. Our comments are:

Page II - 23. Onshore construction such as pipes and pumps will require the special management area review process.

Page IV - 7. Sewerage. We know that the Department of Health evidently has minimum standards which permit septic tanks or leaching fields in this situation/location. Throughout this draft EIS, it is repeatedly stated that preserving the ocean water quality is of the utmost importance. The DOH's strong recommendation in their April 10, 1985, memo is that a centralized sewerage system would be better than septic tanks or leaching fields.

Archaeological. Before any physical alteration of the area takes place, salvage excavation should be conducted, as recommended in the Archaeological Reconnaissance Survey report by Chiniago, Inc.

Sincerely,

Albert Lono Lyman
ALBERT LONO LYMAN
Planning Director

DT:acb



HIGH TECHNOLOGY DEVELOPMENT CORPORATION

Central Pacific Plaza 220 South King Street, Suite 252
Hilo, Hawaii 96720
Telephone (808) 548-8996

Mailing Address: P.O. Box 2359, Honolulu, Hawaii 96804

August 27, 1985

GEORGE R. ARYOSHI
Executive Director
K. TIM YEE
Chairman
WILLIAM M. BASS, JR.
Executive Director

Mr. Albert Lono Lyman
Planning Director
County of Hawaii Planning Department
25 Aupuni Street
Hilo, Hawaii 96720

Dear Mr. Lyman:

Subject: Draft Environmental Impact Statement-- Development Plan for the Hawaii Ocean Science & Technology Park and Proposed Expansion of the Natural Energy Laboratory of Hawaii at Keahole, North Kona, Hawaii

Thank you for reviewing the subject draft EIS. In response to your specific comments:

1. Page II-23: Your comment that onshore construction such as pipes and pumps will require the special management area review process has been incorporated into the Final EIS.

2. Page IV-7: The final decision on domestic wastewater disposal will be made after further discussions with appropriate agencies. The County of Hawaii will also be consulted on this matter. The analysis presented in the draft EIS (page IV-41-42 and Appendix C), however, indicates that impacts of disposal of domestic wastewater via septic tanks with leaching fields would be insignificant. The Development Rules for ROST Park and tenant agreements at NELH will specify that laboratory wastes, solvents, chemicals, biocides, etc. cannot be discharged into septic tanks. A plan for their disposal will be incorporated into the Development Rules.

3. Recommended mapping and salvage excavation of historical sites will be undertaken prior to physical alteration of the area.

Your comments on the draft EIS are appreciated.

Sincerely,

William M. Bass, Jr.
William M. Bass, Jr.

cc: OEQC
Land Use Commission
NELH
DPED Energy Division

GENPP 19-7
H-W/G



HIGH TECHNOLOGY DEVELOPMENT CORPORATION

Central Pacific Plaza, 220 South King Street, Suite 252
Telephone (808)548-9595

GEORGE R. ARIYOSHI
Governor
K. TIM YEE
Chairman
WILLIAM M. BASS, JR.
President/Director

Mailing Address: P.O. Box 2359 Honolulu, Hawaii 96804



August 7, 1985

August 27, 1985

Letitia M. Uyebara, Director
Office of Environmental Quality Control
550 Halekauwila Street, Room 301
Honolulu, Hawaii 96813

Dear Ms. Uyebara:

Subject: Draft EIS - Development Plan for Host Park and Proposed
Expansion of NELH, Keahole Hawaii

Thank you for the opportunity to comment on the EIS. Our comments on
Section 2.3 follows:

1. HELCO will require approval from the State of Hawaii Department of Transportation to underbuild the existing 69KV Transmission Line along the Queen Kaahumanu Highway with 12.47KV distribution lines from existing substations located at Keahole and Kaloko. The separate overhead feeders from each of the substations will support the anticipated 10-12MW loads, however, improvements to Keahole Substation will be required.
2. If the request to underbuild the existing 69KV line with 12.47KV lines is denied, a new substation must be constructed within the area directly across the NELH access road. The substation site will encumber a minimum fenced area of 10,000 sq. ft. (100' x 100'). The infrastructure will include concrete pads for transformers, switchgears and other pad mounted equipment, concrete foundations for steel structures and buses and possibly a control building.

If there are any questions, please call me.

Very truly yours,

Alva K. Nakamura, Manager
Engineering Department

AKM:ts

cc: Mr. William M. Bass, Jr.
Ms. Marilyn C. Metz

Mr. Alvah K. Nakamura
Manager

Engineering Department
Hawaii Electric Light Company, Inc.
P.O. Box 1027
Hilo, Hawaii 96720

Dear Mr. Nakamura:

Subject: Draft Environmental Impact Statement-- Development Plan for the
Hawaii Ocean Science & Technology Park and Proposed Expansion of
the Natural Energy Laboratory of Hawaii at Keahole, North Kona,
Hawaii

Thank you for reviewing the subject draft EIS. Your comments have been
incorporated into the Final EIS.

We appreciate all of the assistance that you have given us on this
project and our consultants will continue to coordinate their planning
and design activities with your office.

Sincerely,

William M. Bass, Jr.
Executive Director

cc: OEOC
Land Use Commission
County of Hawaii Planning Dept.
NELH
DPED Energy Division

Attilia N. Gjyckara
Office of Environmental Quality Control
550 Halekuanila St. Pm 501
Honolulu, HI. 96813



Aug 22, 85

Dear Mrs. Uytken:

Regarding the Draft EIS Development Plan for Hawaii Ocean Science & Technology Park and Proposed Expansion of National Energy Laboratory of Hawaii.

Some comments I wish to express are:

1) Air quality: Levels of lead, carbon monoxide, and carbon dioxide and other pollutants from airplanes exhaust should be quantified to establish whether or not workers will be exposed on a daily basis to too high levels.

2) The EIS should include all preliminary and year by year abstract of all chemicals used for fertilizing and eradicating weeds. All chemical use of this sort should be banned because of the proximity of the soil and proximity to the ocean.

The coastline is an especially delicate ecosystem and pesticide run off has virtually no filtration system.

3) The sewage system should be carefully looked at because of the movement of water through the water line - perhaps a series of composting toilets should be considered. There have been working in California quite well - especially at the Environmental Campground south of Steam Beach, California.

4) Use of the Industrial Park already built on Aug. 119 area for the OTEC area should be considered. How much of this already established Industrial Park is still available for leasing? Could the cold water pipeline be extended to it? (and return pipeline?)

5) Could return water be processed through the early sewage system?
6) What steps will be taken when businesses enter into an agreement to operate at OTEC to ensure environmentally hazardous substances will not enter this return flow water? Will Environmental Impact Statement be required of all businesses using the cold water system?
7) Beauty of the building and surrounding site should be considered of top priority.

Thank you for this opportunity to comment.

Alida
Village Falls
P.O. Box 588
Capt. Cook, HI. 96704

copies sent to:
Mr. Bass, Jr.
High Technology Development Corp.
Central Pacific Plaza, Suite 250
220 St. King St.
Honolulu, HI 96813

and
As. Design Mfg. Inc.
P.O. Box 27606
Honolulu, HI 96827

AUG 26 1985



HIGH TECHNOLOGY DEVELOPMENT CORPORATION

Central Pacific Plaza, 220 South King Street, Suite 252
Telephone: (808) 548-6956

GEORGE R. AYOZOSHI
K. TIM VEE
WILLIAM M. BASS, JR.
EXECUTIVE DIRECTOR

Mailing Address: P.O. Box 2359 Honolulu, Hawaii 96804

August 29, 1985

Mr. Jacques Prell
August 29, 1985
Page 2

Mr. Jacques Prell
P.O. Box 888
Captain Cook, HI 96704

Dear Mr. Prell:

Subject: Draft Environmental Impact Statement-- Development Plan for the Hawaii Ocean Science & Technology Park and Proposed Expansion of the Natural Energy Laboratory of Hawaii at Keahole, North Kona, Hawaii

Thank you for reviewing and commenting on the subject draft EIS. In response to your specific comments:

1. The Keahole Airport Master Plan is presently in process. The air quality parameters which you mentioned are being determined as part of this plan. Both HOST and NELH are concerned about exposure of their workers and will encourage the airport to take appropriate mitigating measures if is determined that they are needed.
2. At the present time, there are no plans for using chemicals for fertilizer or for eradicating weeds. Mariculture products proposed for the facilities are for human consumption, therefore, they must be protected from contamination.
3. Your suggestion for using compost toilets will be considered when developing the design criteria for the project. This is a very helpful recommendation.
4. We do not know what "Industrial Park" you are referring to. There is an agriculture park across Queen Kaahumanu Highway from the project site. To our knowledge all of the lots in that park have been leased. There is also a privately-owned industrial park some miles south of the HOST park site. We do not know how much land is available in that park, however, extending the sewer supply system to either location would be extremely costly, both in pipe construction and in pumping costs. The costs of the sewer would be prohibitive in these locations, precluding the economic feasibility of producing mariculture products for market.

5. There is no County sewer system in the area and the existing system is not planned to be extended to the Keahole area. If such a system existed, however, sized to accommodate HOST Park, we see no reason why the seawater return flows could not be disposed of in that manner.

6. Restrictive development rules covering the areas of your concern are being written for the HOST Park. There will be a public hearing on these rules which, I hope you will attend. It is not anticipated that additional environmental impact statements will be required for all businesses using the cold water system unless it is determined that the impacts will be significantly different from those discussed in this EIS. In addition, each project will be subject to the County of Hawaii, special management area review process.

7. Aesthetics of the buildings and surrounding sites is important. Design criteria which will be incorporated into the development rules will provide standards for development and construction. In addition, a design review committee will evaluate all building plans before facilities are constructed.

Sincerely,

William M. Bass, Jr.
William M. Bass, Jr.
Executive Director

cc: OEQC
LUC
County of Hawaii Planning Dept.
NELH
DPED, Energy Division

TSA INTERNATIONAL, LIMITED
1150 SOUTH KING ST., SUITE 901A
HONOLULU, HAWAII 96814

August 23, 1985

Ms. Letitia Uyebara, Director
Office of Environmental Quality Control
550 Halekauwila Street, Room 301
Honolulu, Hawaii 96813

Subject: Draft Environmental Impact Statement for
Development Plan for the
Hawaii Ocean Science & Technology Park and
Expansion of the Natural Energy Laboratory of Hawaii
Keahole, North Kona, Hawaii

Dear Ms. Uyebara:

We have reviewed the Draft Environmental Impact Statement for the subject project and offer the following comments.

The basic concept and purpose of Hawaii concentrating its efforts and resources on developing those forms of high technology that build upon its unique resources and the geographic advantages derived from its location in the middle of the Pacific Ocean is indeed, very sound.

The selection of the 547-acre parcel of state owned land at Keahole, Hawaii for the ocean-related "high-tech" park because of the unique features which the site offers is also, very sound. The unique resources such as nutrient-rich, pathogen-free cold ocean water drawn from depths of 2,000 feet below sea level and located relatively near shore; high year-round solar radiation with little cloud cover; semi-tropical temperatures and a near hurricane-free environment with good access to airport and harbor facilities make this an excellent site for such "ocean related high-tech" activities.

The State, in addition to the construction and installation of the standard infrastructure normally required in a subdivision development, will be constructing and installing cold seawater and warm seawater intake pipes of undetermined sizes together with a distribution system throughout the HOST Park.

There are no cost estimates stated in the draft EIS, however, the cost can be expected to be quite substantial. The operational and maintenance costs for the cold and warm seawater distribution system should be quite expensive. In any event, it appears to be very apparent that this special system, installed for a specific purpose, must be utilized to its optimum capacity in order to derive maximum benefit therefrom, and thereby minimizing the unit cost to the ultimate user.

Ms. Letitia Uyebara, Director
August 23, 1985
Page Two

Further, the parcel consisting of 574 acres is not an overly large parcel of land for the intended purpose over an extended period of time. Being that this is the extent of the state-owned land south of Keahole Airport, it is imperative that the land be availed only for activities and endeavors that are dependent on the so-called "unique resources". This is the only way in which optimum benefit can be derived from this particular site with its "unique resources" especially suited for "ocean-related high-tech" activities and supposedly being developed for said purpose.

The Development Scenarios A, B and C described on Pages II-9 thru II-15 in the subject document clearly depicts the uncertain condition of the present and future demand for such land which are designated for Ocean Water Commercial Use. The land areas given in the various scenarios are as follows:

TYPES OF USES/SCENARIOS	A	B	C
Ocean Water Commercial Use (20 Ac. Min.)	385 Ac. 19 Lots	285 Ac. 14 Lots	165 Ac. 8 Lots
Campus Industrial/Service & Support (3 Ac. Min.)	78 Ac. 59 Lots	178 Ac. 59 Lots	300 Ac. 99 Lots

The foregoing demonstrates that the need and demand for such land at the present time is at best, very uncertain. On page II-6, it is stated, "A conceptual plan for the HOST Park was presented as part of the marketing and feasibility studies for the HOST Park (Helber, Haster, Van Horn & Kimura, Inc., 1985)". However, no details of the study are given. What did the market research show? It is further admitted on numerous occasions in the draft EIS that the need and demand for such lands are unknown. Scenarios A, B and C clearly show that in the event the demand for Ocean Water Commercial Use is negligible, the alternative action is to expand the Campus Industrial/Service and Support lands. This is contrary to the intent and purpose for which this "OCEAN RELATED HIGH TECH" project was conceived. The alternative action for "worst case" event is totally unjustified and is just the kind of action which should be avoided. Accordingly, Scenarios A, B and C should be completely revised to reflect a more definitive plan strictly for systematic implementation of "Ocean Related High-Tech" development. This would then be in keeping with the intent and purpose for which this specific site was selected.

Ms. Letitia Uyebara, Director
August 23, 1985
Page Three

Other so called "High-Tech" developments which are not dependent on the unique resources of the Keahole site, can be developed at any other location on any Island. New "High-Tech" parks have been proposed on other Islands. In Kona, the private sector provides adequate available light industrial lands in close proximity to Keahole, for support services. As long as the private sector can provide satisfactory alternatives for such needs, the government should not duplicate and be in direct competition with the private sector.

Numerous other very fundamental questions are vague and unclear in the document. The document is obviously a very hasty compilation of data, rather than an in-depth study of all pertinent matters. As such, a good portion of it is very sketchy and needs to be reevaluated and redone. Basic policies for project acceptance and criteria for acceptance are lacking. In addition to policies assuring "ocean-related high-tech" use, specific conditions, covenants and restrictions (CC & R's) for the HOST Park must be formulated. Previous high-tech park proposals in the State of Hawaii by the private sector have included highly detailed and sophisticated studies of market conditions, trends and needs. These studies provided the necessary basis to substantively justify and properly review impacts of the proposed high-tech parks. Such studies have not been prepared, and is absolutely necessary.

In view of the foregoing, it is recommended that the State take another hard look at this very worthwhile project and engage the services of qualified consultants to determine basic needs, policies and other basic facts. This can then be the basis for a positive approach rather than this uncertain approach with three very diverse scenarios which could very well prove to be detrimental to the success of this extremely valuable project.

Please place us on your mailing list and we will appreciate receiving any and all information relative to this project, including the Final EIS, Master Plan, and CC & R's.

We appreciate this opportunity to express our views and respectfully request your consideration of our concerns.

Sincerely,

TSA INTERNATIONAL, LIMITED



Kazuo Omrya, Vice President

KO/em



HIGH TECHNOLOGY DEVELOPMENT CORPORATION

Central Pacific Plaza, 220 South King Street, Suite 252
Telephone (808) 543-8996

August 29, 1985

Mailing Address: P.O. Box 2359 Honolulu, Hawaii 96804

GEORGE R. ARIVOSHI
PRESIDENT
K. TIM YEE
CHAIRMAN
WILLIAM M. BASS, JR.
EXECUTIVE DIRECTOR

Mr. Kazuo Omrya, Vice-President
TSA International, Limited
1150 South King Street, Suite 901A
Honolulu, Hawaii 96813

Dear Mr. Omrya:

Subject: Draft Environmental Impact Statement-- Development Plan for the Hawaii Ocean Science & Technology Park and Proposed Expansion of the Natural Energy Laboratory of Hawaii at Keahole, North Kona, Hawaii

Thank you for your comments on the subject draft EIS. Although your comments were received after the prescribed deadline, we are responding to your letter and incorporating it into the Final EIS because we realize your concern that HOST Park may compete with private developments in the Kailua-Kona area.

The EIS was prepared to reflect "worst-case" conditions so that environmental concerns would not be understated. Scenario A reflected the "worst-case" condition for seawater return flows and Scenario C reflected the "worst-case" condition for buildings and paved surfaces. Both have environmental implications that were best addressed in that manner.

Since the EIS was published, additional detailed planning has been undertaken. The detailed master plan reflects a variation of Scenario A with the majority of the acreage set aside for large aquaculture lots. In any event, all activities at HOST Park must be ocean-related. This will be a condition of the lease agreement between HOST and DLNR.

In answer to specific comments:

At the present time, the State plans to construct and install the cold and warm seawater intake pipes to header tanks located at one or two elevations on the HOST Park site. The distribution pipes for this water will be the responsibility of each particular tenant. Operational and maintenance costs will also be paid by the users.

Mr. Kazuo Omrya
August 29, 1985
Page 2

The development scenarios were in no way intended to reflect the need and demand for land. They are merely alternatives which were addressed in the EIS to fulfill the EIS requirements that alternatives be assessed. Because the exact number of parcels required for each use was uncertain, extremes were analyzed so that potential environmental impacts would be fully evaluated.

Expansion of the Campus Industrial/Service and Support lands for non-ocean related uses is not allowed under the terms of our lease or executive order.

A definitive plan for implementation of the Hawaii Ocean Science & Technology Park is being prepared. It will not be finalized until all State and County approvals have been obtained. Again, we must repeat that the development scenarios are not intended to be development directions, per se. As stated previously, HOST Park will be restricted to ocean-related uses. The government has no intention to compete with the private sector for tenants.

We do not understand what you mean by "fundamental questions are vague and unclear in the document," and we disagree that the document was very hasty compilation of data, rather than an in-depth study of all pertinent matters. The document is an environmental impact statement and not a master plan, engineering design document, or market study. We retained the best consultants available to assess the implications of actions which have the potential of significantly impacting the environment. These include: seawater return flows, biological oceanography, pipe deployment, construction activities, and population growth and housing implications. A market study is not a requirement of an environmental impact statement under EIS Regulations.

The High Technology Development Corporation Board of Directors is responsible for setting policy for the HOST Park within the limitations of its enabling legislation. The basic policy governing HOST Park is that it is intended for ocean-related high technology uses.

The Department of Accounting and General Services has retained qualified consultants to finalize the implementation of the master plan and prepare draft Development Rules (CC&R's and Design Standards) for the proposed Park. Criteria for tenant selection will be included in these rules. Environmental mitigating measures as outlined in this EIS and as placed upon the project by various permitting agencies will also be included. These rules are subject to the State Administrative

Mr. Kazuo Omrya
August 29, 1985
Page 3

Procedures Act and will require a public hearing. They cannot be finalized until after the public hearing.

Further market studies are being undertaken to identify specific tenants for the Park. Representatives from two mariculture firms testified at the Land Use Commission hearing for the project and stated a potential requirement for a total of 180 acres in the HOST Park between them. These firms relocated from the mainland to NELH because of the cold, nutrient-rich deep ocean water. Because the space available for mariculture activities at NELH is limited, HOST Park is necessary for the expansion of their operations. We anticipate additional firms will "grow-out" of NELH or relocate from other locations to absorb the mariculture lots within five to ten years.

The High Technology Development Corporation will conduct public hearings prior to adoption of the development rules, and you will be notified of the date and time of that hearing per your request. The other anticipated hearings will be conducted by Hawaii County and perhaps DLNR. We recommend that you notify them directly of your desire to be notified.

Budget constraints limit the number of copies of the final EIS, master plan and other documents associated with the project. However, these documents will be available for review at various libraries throughout the State and at this office.

I hope this information has resolved any misunderstandings that the multiple development scenarios in the draft EIS may have caused and that it is clear that we are truly planning to develop a park for ocean-related high technology applications.

Sincerely,

William M. Bass, Jr.

cc: OEQC
LUC
County of Hawaii Planning Dept.
NELH
DPED, Energy Division

